



Annual Report 2021

Infineon Technologies AG



Contents

2 Infineon key data	49 Combined Management Report	152 Consolidated Financial Statements
3 Infineon at a glance	50 Business model	153 Consolidated Statement of Profit or Loss
4 The segments	52 Review of the semiconductor industry	153 Consolidated Statement of Comprehensive Income
5 Our year at a glance	55 2021 fiscal year	154 Consolidated Statement of Financial Position
6 Management Board and Supervisory Board	58 The segments	155 Consolidated Statement of Cash Flows
6 Letter to shareholders	80 Research and development	156 Consolidated Statement of Changes in Equity
10 The Management Board	88 Manufacturing	158 Notes to the Consolidated Financial Statements
12 Report of the Supervisory Board to the Annual General Meeting	92 Internal management system	232 Further information
20 Business focus and strategy	95 Sustainability at Infineon	232 Responsibility Statement by the Management Board
20 Business focus	96 The Infineon share	233 Independent Auditor's Report
22 Growth drivers	99 Group performance	240 Applications and product range
35 Group strategy	109 Report on outlook, risk and opportunity	244 Chart overview
47 Human Resources strategy	124 Overall statement on Infineon's financial condition	245 List of abbreviations
	125 Infineon Technologies AG	246 Financial calendar 2022
	128 Corporate Governance	247 Imprint
	151 List of references	

Navigation in the report per mouse click

- ← Last page viewed
- 🔍 Search
- ☰ Main table of contents
- < Previous page
- > Next page

Further information

- 📄 Page reference
- 📊 Chart reference
(Chart overview on [p. 244](#))
- 💬 Reference
(List of references on [p. 151](#))
- 📄 Reference to external document

This interactive pdf is optimized for use with Adobe Acrobat.

Infineon key data¹

Fiscal year from 1 October to 30 September	2021		2020		2021/2020 Change in %
	€ in millions	in % of revenue	€ in millions	in % of revenue	
Revenue by region	11,060		8,567		29
Europe, Middle East, Africa	2,773	25	2,322	27	19
therein: Germany	1,278	12	1,056	12	21
Asia-Pacific (excluding Japan, Greater China)	1,744	16	1,291	15	35
Greater China	4,195	38	3,174	37	32
therein: Mainland China, Hong Kong	3,178	29	2,472	29	29
Japan	1,094	10	765	9	43
Americas	1,254	11	1,015	12	24
therein: USA	1,027	9	845	10	22
Revenue by segment	11,060		8,567		29
Automotive ²	4,841	44	3,521	41	37
Industrial Power Control	1,542	14	1,406	17	10
Power & Sensor Systems	3,268	29	2,650	31	23
Connected Secure Systems ²	1,397	13	974	11	43
Other Operating Segments	12	0	16	0	(25)
Corporate and Eliminations	-	-	-	-	-
Gross profit/Gross margin	4,260	38.5	2,776	32.4	53
Research and development expenses	(1,448)	13.1	(1,113)	13.0	30
Selling, general and administrative expenses	(1,354)	12.2	(1,042)	12.2	30
Operating profit	1,470		581		153
Profit (loss) from continuing operations	1,175		372		216
Profit (loss) from discontinued operations, net of income taxes	(6)		(4)		(50)
Profit (loss) for the period	1,169		368		218
Segment Result/Segment Result Margin	2,072	18.7	1,170	13.7	77
Property, plant and equipment	4,443		4,110		8
Total assets	23,334		21,999		6
Total equity	11,401		10,219		12

Fiscal year from 1 October to 30 September	2021		2020		2021/2020 Change in %
	€ in millions	€ in millions	€ in millions	€ in millions	
Net cash provided by operating activities from continuing operations	3,063		1,817		69
Net cash used in investing activities from continuing operations	(2,284)		(7,172)		68
Net cash provided by (used in) financing activities from continuing operations	(885)		6,274		(114)
Free Cash Flow ³	1,574		(6,727)		123
Depreciation and amortization	1,513		1,260		20
Investments ³	1,497		1,099		36
Gross cash position ³	3,922		3,227		22
Net cash position ³	(2,663)		(3,806)		30
Basic earnings per share in €	0.87		0.26		235
Diluted earnings per share in €	0.87		0.26		235
Adjusted earnings per share in € – diluted ⁴	1.20		0.64		88
Dividend per share in € ⁵	0.27		0.22		23
Equity ratio	48.9%		46.5%		
Return on equity ⁶	10.3%		3.6%		
Return on assets ⁶	5.0%		1.7%		
Inventory intensity ⁶	9.3%		9.3%		
Debt-to-equity ratio ⁶	57.8%		68.8%		
Debt-to-total-capital ratio ⁷	28.2%		32.0%		
Return on Capital Employed (RoCE) ³	8.4%		3.0%		
Infineon employees as of 30 September	50,288		46,665		8

1 Columns may not add due to rounding.

2 The business with the XMC™ family of industrial microcontrollers was transferred from the Automotive segment to the Connected Secure Systems segment with effect from 1 October 2020. The previous year's figures have been adjusted accordingly.

3 See the chapter "Internal management system" for definition, [p. 93 f.](#)

4 See the chapter "Review of results of operations" for definition, [p. 103.](#)

5 A dividend per share of €0.27 for the 2021 fiscal year will be proposed to the Annual General Meeting on 21 February 2022.

6 See the chapter "Review of financial condition" for definition, [p. 103.](#)

7 Debt-to-total-capital ratio = long-term and short-term financial debt divided by total assets.

Infineon at a glance

Infineon Technologies AG is a world leader in semiconductor solutions that make life easier, safer and greener. Microelectronics from Infineon is the key to a better future. In the 2021 fiscal year (ending 30 September), the Company reported sales of approximately €11.1 billion with some 50,280 employees worldwide. Infineon is listed on the Frankfurt Stock Exchange (ticker symbol: IFX) and in the USA on the over-the-counter market OTCQX International Premier (ticker symbol: IFNNY).

Part of your life.
Part of tomorrow.

#9

in the entire semiconductor market 🗨️ R01

50,280
employees

#3

in microcontrollers 🗨️ R01

The segments

Automotive



📄 p. 60

Key customers¹

Aptiv / BorgWarner / Bosch / BYD / Continental / Denso / Hella / Hitachi / Hyundai / Lear / Mando / Mitsubishi Electric / Nidec / Preh / Valeo / Veoneer / Vitesco / ZF

Market position²

#1 with a market share of 13.2% for automotive semiconductors, 🗨️ R02³

#4 with a market share of 15.1% for NOR Flash memory ICs, 🗨️ R01

Industrial Power Control



📄 p. 65

Key customers¹

ABB / Alstom / CRRC / Danfoss / Goldwind / Inovance / LG Electronics / Midea / Rockwell / Schneider Electric / Semikron / Siemens / SMA / Sungrow / Vestas / Yaskawa

Market position²

#1 with a market share of 36.5% for IGBT modules, 🗨️ R03

#3 with a market share of 11.6% for IPMs, 🗨️ R03

Power & Sensor Systems



📄 p. 70

Key customers¹

Airbus / Alibaba / Amazon / Baidu / Boeing / Cisco / Dell / Delta / Ericsson / Goertek / Google / Lenovo / Lite-On / Makita / Nokia / Osram / Quanta / Samsung / SolarEdge / ZTE

Market position²

#1 with a market share of 24.4% for power MOSFETs, 🗨️ R03

#1 with a market share of 44.2% for MEMS microphones, 🗨️ R04

Connected Secure Systems



📄 p. 75

Key customers¹

CPI Card Group / Fitbit / Giesecke & Devrient / Harman / HP / Idemia / Lenovo / Microsoft / Nintendo / Perfect Plastic / Seiko Epson / Sony / Thales / US Government Publishing Office

Market position²

#1 with a market share of 24.6% for secure ICs (excluding NFC), 🗨️ R05

#3 with a market share of 14.7% for microcontrollers, 🗨️ R01

Major distributions customers¹

Arrow / Avnet / Future / Hakuto / Intron / Jingchuan / Macnica / Nexty / Rutronik / Weikeng / WPG Holding (SAC)

Please find a detailed presentation of the segments' target applications and product range in the chapter "Applications and product range", 📄 p. 240 ff.

¹ In alphabetical order.

² All figures for the 2020 calendar year. The market share of the five largest competitors is shown in the "Market position" section of the relevant segment. The figures provided in those sections with respect to changes in market share relate to the 2020 and 2019 market share figures as calculated in 2021. Due to changes in the way the market is analyzed, these figures may differ from the 2019 market share figures reported in 2020.

³ A list of references can be found on 📄 p. 151.

Our year at a glance

REVENUE

€11.060 bn
+29%

INCLUSION IN THE
**EURO
STOXX 50®**

SEGMENT RESULT
AND MARGIN

€2.072 bn
≙ 18.7%



The coronavirus pandemic continued to have an impact in the 2021 fiscal year. The unexpectedly strong recovery of the global economy by the end of the 2020 calendar year led to a boom in demand in many sectors and a resultant shortage of semiconductor components.

We are continuing to focus on the structurally fast-growing themes of electrification and digitalization. With Cypress, we have significantly increased our expertise in system solutions, especially with regard to the IoT.

The integration of Cypress and the refinancing of this acquisition are proceeding on schedule. In March 2021, capital market confidence in Infineon's economic prospects resulted in the inclusion of our shares in Europe's most prestigious stock market index, the EURO STOXX 50®.

Sustainability plays a key role for Infineon. At the beginning of 2020, we had already set ourselves the goal of becoming carbon-neutral by 2030. Our high sustainability ratings and our inclusion in sustainability indices are both our reward and our motivation.

Letter to shareholders

Dr. Reinhard Ploss
Chief Executive Officer



Neubiberg, November 2021

Dear readers,

Many of you have been following Infineon's progress for a number of years. You know that one really important factor in the success of the Company is our deep conviction that we can use innovative technology to contribute towards solving major challenges. Whether we are talking about the climate crisis, dwindling resources or population growth, the urgent issues of our time require intelligent concepts and solutions that enable us to lead a sustainable and secure life. Infineon, which acts as a link between the real world and the digital world, is more in demand than ever, and we have never been in a better position than we are today.

Strategic focus on electrification and digitalization trends

Our portfolio is firmly focused on the two major trends of the coming decade: electrification and digitalization. Both trends and the interplay between them will accelerate structural semiconductor growth. Tomorrow's energy-efficient, connected world is built on semiconductors. In the Internet of Things (IoT), our products and solutions enable new functions and services. IoT devices capture their surroundings and process the data and, in doing so, they interact with the cloud and perform actions. A good example is the fully automatic vacuum cleaner, which also works in a very energy-efficient way. Key elements in IoT are sensors, microcontrollers and power semiconductors, as well as connectivity and security solutions, supplemented by software. Infineon offers all of these elements and makes leading-edge applications possible – from electric cars that drive autonomously to home solar systems with buffer batteries, and much more. Thus, we are able to live up to our claim that we make life easier, safer and greener. Our contribution to climate protection is not limited to the contribution made by our products: As a company, we want to become carbon-neutral by 2030.

A key aspect of our strategy is P2S: from product thinking to system understanding. We adopted this approach years ago, laying the foundations for our present success. Thanks to P2S, we are able today to provide our customers in many areas with complete system solutions, including the related software. Why is that so important? Many of our target applications are becoming increasingly complex – the best example of this is the car: digitalization and electrification are shaping the vehicles of tomorrow. The number of electronic systems due to driver assistance, infotainment and comfort applications is constantly rising. Battery-powered electric motors are increasingly used in power trains. We understand the car as a system and can offer solutions that contribute towards enabling transformation and mastering ever greater complexity. Understanding the target application also means developing components that solve the problem most effectively. P2S is one of our great strengths and has brought us success in the market.

In the area of digitalization, we are benefiting more and more from the synergies arising from the combined portfolio of Infineon and Cypress. Integration is progressing well, and we can see that the acquisition is delivering on its promises. We provided detailed explanations of the resulting growth opportunities for Infineon at our Investor Day (IFX Day 2021) in October. In particular, we described how we have acquired leading positions in markets of the future by investing early and consistently strengthening our success factors.

The effects of the coronavirus pandemic and the lessons learned

Both trends – electrification and digitalization – have been reinforced still further by the coronavirus pandemic in the past eighteen months. There was a veritable boom in some industry sectors, such as hardware for remote working, home schooling and games consoles, and battery-powered DIY tools.

At the beginning of the pandemic, it still looked as if large sections of the global economy would grind to a halt, whereas manufacturers in the area of IoT and digital interaction and infrastructure saw a strong upturn. The auto industry in particular

slashed its forecasts and cut back its orders, with the overall result being weak revenue for Infineon. Our experience from the last crisis prompted us to scale back our manufacturing to a significant extent, but to make only moderate reductions in our inventory and investment. Some industry observers and investors were skeptical of this approach, but it turned out to be the right one. Already in the second half of the 2020 calendar year, some severely affected economic sectors picked up speed again. In the automotive market, a catch-up effect started to be seen, while at the same time, the trend towards electromobility continued to accelerate. The result was a chip shortage that persists to this day, caused in part by the shifting of production capacity at our contract chip manufacturers towards supplies for use in laptops, tablets and servers. The situation was exacerbated by production stoppages due to pandemic-related lockdowns, especially in Asia, and by environmental disasters and accidents affecting several semiconductor manufacturers' plants.

Without such constraints, we would have generated significantly higher revenue in the previous fiscal year, because demand in almost all our markets has been and remains very high. Even though we are currently still not able to fully satisfy the high levels of demand, our customers have expressed their great appreciation of our efforts. They realize and acknowledge that we do everything in our power to meet their needs. The feedback we have from our customers, especially those in the automotive sector, is that our reliability and commitment set us apart, when compared with other experiences they have had in the market.

Current issues with allocation have only strengthened our view that we also need to champion our own manufacturing. The most critical bottlenecks arose for products that come from foundries – in some product categories, we are dependent on their supplies, as well. However, we are less dependent on foundries than competitors with fabless business models and, if we look across our entire portfolio, we are more resistant to supply problems. We have continued to develop our collaboration with contract manufacturers and have broadened our supplier base, so that in the future we will be even better equipped to deal with fluctuations in the supply situation.

It is important now to draw the correct conclusions from the tense supply situation, and to do so across all industry sectors. More complex technologies, applications and supply chains are becoming part of the new normal. As a company, we need to adapt. Today, even isolated events that are primarily regional can rapidly have an impact on global supply chains. The just-in-time model needs updating. There is the need for an approach that encompasses available capacity, inventories and supply management and that is proactive, changing the focus according to each situation and across individual company boundaries. The first step in such an approach is intelligent inventory management. Moreover, all partners along the value chain need to understand the new dynamic in the market and provide appropriate flexibility.

The serious consequences of the chip shortage have demonstrated the relevance of the semiconductor industry to almost all other industry sectors. The industry is increasingly becoming the focus of economic and geopolitical competition in all regions of the world. Turning the clock back on globalization is not a viable solution. However, Europe must decide in which areas and to what extent it is prepared to accept technological dependence on other continents – as well as the areas and extent to which such dependence is not acceptable.

Looking back, we can say that, as a company, we have dealt well with the pandemic to date. This is thanks to the great commitment of our employees. Infineon has performed well due to their exceptional dedication and has at the same time been pressing ahead with the evolution and implementation of its long-term strategy.

Success factors and evolution of our company

A significant element of our strategic evolution is the expansion of our own manufacturing landscape. Without a doubt, the most important milestone was the opening of our new 300-millimeter semiconductor manufacturing facility in Villach (Austria) on 17 September. We will operate the new factory, together with our factory in Dresden (Germany), as one unit based on the One Virtual Fab concept, which gives us more flexibility and greater economies of scale. As a result, we are strengthening

our undisputed leading position in power semiconductors, in light of the trend towards electrification. Our concept for expanding manufacturing capacity involves initially preparing the clean room and then ramping this up over time in response to demand. Production at the new Villach factory will be increased gradually based on this principle.

We differentiate ourselves clearly from our competitors not only because we have our own manufacturing facilities, but also because of our technological expertise, for example, in the area of compound semiconductors based on silicon carbide (SiC) and gallium nitride (GaN). In many applications, silicon-based power semiconductors are the optimal solution in technical and economic terms, especially for low switching frequencies. Power semiconductors based on SiC and GaN, on the other hand, enable faster switching speeds and significantly higher power density. We see rapidly growing demand for SiC-based power semiconductors above all in the automotive market but also in industrial applications and are therefore expanding our CoolSiC™ portfolio in particular, both in the area of discrete components and that of modules. We are also expanding our GaN product range. In addition, we are investing increasingly in the expansion of our manufacturing capacity for SiC and GaN to maintain our leading role across the entire range of power semiconductors, paving the way for further enhancements in energy efficiency. This is significant, as the world of the future is electric.

As I explained at the beginning, digitalization is a key growth driver for our business. It also offers huge opportunities for the evolution of our company. Growth, globalization, the focus on system solutions – we will be able to deal better with all these issues by applying digital solutions. In terms of our offering, this means, for example, that we are working increasingly on delivering our solutions inclusive of software and on expanding our solutions to include services. In our interaction with customers, we can also, in many cases, become faster and more efficient by using digital channels and platforms. The digital transformation also offers great opportunities for enhancing our internal processes and working practices.

The Management Board was expanded in April in order to coordinate these activities across the whole company and a post was created for the transformation of Infineon in the digital context. Innovative strength, our focus on applications and our global presence in growth markets are the basis of our success. We need to strengthen the digital links between the major organizational units such as Technology Development and Manufacturing or Sales and Marketing and to make knowledge available across the whole company in order to continue our dynamic evolution in these areas, despite our increasing size and complexity. The Management Board and the Supervisory Board have together devised a structure that highlights Infineon's current strengths and enables targeted further development of our digital expertise. We are delighted that Constanze Hufenbecher has strengthened our Management Board team and will address these topics on behalf of our company. With her wealth and breadth of experience, she is the ideal manager for this role.

Capital market successes and outlook

As we look back at the 2021 fiscal year, the mentioned challenges we faced and the major milestones we achieved stand out in particular. In addition, there were a number of other important events and developments that I would like to touch on briefly here.

With a US\$1.3 billion private placement of bonds, we successfully pressed ahead with the refinancing of the acquisition of Cypress. In September, thanks to the positive trend in our Free Cash Flow, we were also able to repay early US\$365 million of the term loans raised to acquire Cypress. Here, too, what counts for us is long-term planning security, stability and reliability. In this context, the rating agency S&P Global assigned a positive outlook to our "BBB-" rating this spring.

On 22 March 2021, Infineon moved up into the EURO STOXX 50. We are proud of this achievement, which reflects the success of the whole Infineon team. We have made it into the Champions League of stock markets – and now that we are there, we intend to stay.

Dear readers, the variety and nature of the developments I have outlined above make it clear that the fiscal year just ended was neither normal nor easy. So I would like to thank our employees all around the world most warmly on behalf of the entire Management Board. You have shown great commitment in conditions that were sometimes very difficult, you have supported each other, and you have been tireless in your efforts to help our customers. Thank you so much!

I would also like to thank you, our shareholders, because your continuing confidence has given us the space to concentrate on the important issues relating to the future. At our forthcoming Annual General Meeting, we will propose the payment of a dividend of €0.27 per share. Thus, we want to ensure appropriate participation for you in our success as well as giving us financial room for maneuver to respond to future opportunities, for which Infineon is superbly positioned.

Stay healthy and look to the future with confidence.

Sincerely

Dr. Reinhard Ploss
Chief Executive Officer

The Management Board



Dr. Helmut Gassel
Chief Marketing Officer

Dr. Sven Schneider
Chief Financial Officer

Dr. Reinhard Ploss
Chief Executive Officer

Constanze Hufenbecher
Chief Digital Transformation Officer

Jochen Hanebeck
Chief Operations Officer

Dr. Helmut Gassel

Chief Marketing Officer

Helmut Gassel has been a member of the Management Board and Chief Marketing Officer of Infineon Technologies AG since 2016 (mandated until 30 June 2024). He is responsible for Sales & Marketing, Regions, Strategy Development, Mergers & Acquisitions and Intellectual Property.

Helmut Gassel was born in 1964 in Dortmund, Germany. He holds a Diploma in Physics from the Ruhr-University in Bochum, Germany. He received his PhD in Electrical Engineering from the University Duisburg, Germany. He joined Infineon (Siemens AG until 1999) in 1995.

Dr. Sven Schneider

Chief Financial Officer

Sven Schneider has been a member of the Management Board and Chief Financial Officer at Infineon Technologies AG since 2019 (mandated until 30 April 2027). He is responsible for Accounting & Reporting, Financial Controlling, Financial Planning, Investor Relations, Tax, Treasury, Audit, Compliance, Risk Management.

Sven Schneider was born in 1966 in Berlin, Germany. After completing his studies in business administration (Diplom-Kaufmann), he received his doctorate in business administration from the University of Trier, Germany. From 1995 to 2019, he held several positions at Linde AG, most recently as Spokesman of the Executive Board, Chief Financial Officer and Labor Director.

Dr. Reinhard Ploss

Chief Executive Officer

Reinhard Ploss has been a member of the Management Board of Infineon Technologies AG since 2007. He has been Chief Executive Officer since 1 October 2012 (mandated until 31 December 2022). He is responsible for Divisions, Group Strategy, Communications & Public Policy, Human Resources (Labor Director), Legal, Research & Development.

Reinhard Ploss was born in 1955 in Bamberg, Germany. He studied process engineering at the Technical University of Munich, Germany, and received his doctorate in 1990. He began his career at Infineon (Siemens AG until 1999) in 1986.

Constanze Hufenbecher

Chief Digital Transformation Officer

Constanze Hufenbecher has been a member of the Management Board of Infineon Technologies AG and Chief Digital Transformation Officer since 2021 (appointed until 14 April 2024). She is responsible for Information Technology, Business Continuity, Export Control, Business Excellence, and Sales & Marketing Transformation, as well as the cross-functional tasks of digitalization, process optimization, basic data architecture and implementing major projects.

Constanze Hufenbecher was born in 1970 in Ebingen (now Albstadt), Germany. She received her degree in business administration from the University of Tübingen, Germany. She began her career in 1994 at VIAG AG in Munich, Germany.

Jochen Hanebeck

Chief Operations Officer

Jochen Hanebeck has been a member of the Management Board of Infineon Technologies AG and Chief Operations Officer since 2016 (mandated until 30 June 2024). He is responsible for Operations, including Manufacturing, Logistics, Quality, Customs and Procurement.

Jochen Hanebeck was born in 1968 in Dortmund, Germany. He received a degree in electrical engineering from RWTH Aachen University, Germany. He has been with Infineon since 1994 (Siemens AG until 1999).

Report of the Supervisory Board to the Annual General Meeting



Dr. Wolfgang Eder
Chairman of the
Supervisory Board

Ladies and Gentlemen,

One year ago, I expressed my conviction in this report that Infineon was extremely well positioned to meet the challenges of the coronavirus pandemic and would emerge even stronger from the global health and economic crisis.

Today we can safely state that Infineon can look back upon a highly successful year. An increasing number of global megatrends are being driven by microelectronics technologies, particularly future-critical areas such as electrification and digitalization. Infineon focuses its strategy precisely on these trends and thus continues to tread the path of profitable growth and sustainable value creation. The fact that this development has not escaped the notice of the capital market is underlined not only by the outstanding performance of the Infineon share, but also by its inclusion in the EURO STOXX 50 index.

The huge demand for microchips will continue to influence how Infineon performs in the current fiscal year. Last summer, our most recently constructed fabrication plant went into operation in Villach (Austria). Built at a cost of €1.6 billion, the new plant was the culmination of one of the largest investment projects ever undertaken in the European microelectronics industry. In view of the rapidly growing global demand for power semiconductors, our timing could not have been better. At the time when Infineon took this investment decision, the massive upswing in demand was not in the least foreseeable, but now means that the Group has an advantage over its competitors. This is not only good news for our customers, it also helps Infineon to continue generating a solid return for you, our shareholders. Against this backdrop, the Management Board and the Supervisory Board jointly propose to increase the dividend for the 2021 fiscal year to €0.27 per share.

The market environment remains dynamic, and although that can entail uncertainties going forward, it also gives rise to opportunities, which our management team continues to leverage with great determination. Last but not least, agility is one of the core strengths of Infineon as a high-tech company – true to the motto adopted for the opening of the plant in Villach: “Ready for Mission Future”.

Main activities of the Supervisory Board

During the 2021 fiscal year, the Supervisory Board once again performed its duties with the utmost diligence in accordance with the law, Infineon’s statutes and the Supervisory Board’s own terms of reference. It advised and monitored the Management Board in equal measure, based on detailed written and oral reports presented by the Management Board at Supervisory Board and committee meetings regarding all issues relevant to the Company, focusing for the most part on corporate strategy and planning, current business performance, financial position and risk profile as well as matters relating to risk management and compliance. The Supervisory Board

was always given ample opportunity to thoroughly examine the reports presented by the Management Board and was thus able to satisfy itself that the governance of Infineon's corporate affairs was lawful, compliant and appropriate in every respect. The Supervisory Board was provided with written quarterly reports on Infineon's business performance, key financial data, risks and opportunities and major areas of litigation as well as other specific topics of relevance. Between quarterly reports, the Management Board also provided the Supervisory Board with additional information in the form of monthly reports on current business performance and developments.

As Chairman of the Supervisory Board, I was also in regular contact with both the Chairman (CEO) and the other members of the Management Board between meetings, focusing for the most part on Infineon's corporate strategy, business performance and financial position. Either at or in the context of regular Supervisory Board meetings, the CEO also kept me well informed at all times of other key events – several of which occurred over the course of the challenging twelve-month period under report.

In the 2021 fiscal year, the full Supervisory Board convened six times, holding five ordinary meetings and one extraordinary meeting during that period. One resolution was also passed on the basis of written communication. The attendance rate at Supervisory Board meetings was close to 100 percent; Mr. Scholz was excused from attending two meetings. The attendance rate at the Supervisory Board's committee meetings was 100 percent in all cases. Details of the individual attendance record of Supervisory Board members are provided in the Statement on Corporate Governance www.infineon.com/declaration-on-corporate-governance. Due to pandemic-related restrictions, some of the meetings were held either fully or partially using a virtual format.

In preparation for ordinary Supervisory Board meetings, separate preliminary meetings were held for both the shareholder representatives and the employee representatives. The Supervisory Board also convened regularly without the presence of Management Board members.

Corporate strategy

The Infineon Supervisory Board remains fully committed to providing the Management Board with support in the task of developing and implementing corporate strategy. For this reason, in addition to the regular meetings of the Strategy and Technology Committee, a meeting of the full Supervisory Board was again held during the fiscal year under report with the primary aim of discussing strategic topics. At this strategy meeting, Infineon's growth opportunities, corporate strategy, business model and financial targets were deliberated upon as a coherent whole, also taking into account the fact that semiconductors have increasingly become part of the political agenda in the context of geopolitical tensions and the impact they could have on Infineon. The strategy meeting also focused on digital transformation – a complex range of topics that both the Supervisory Board and the Management Board view as particularly relevant for the future development of the Group.

Personnel matters relating to the Management Board

In light of these and other considerations, the Supervisory Board enlarged the Management Board with effect from 15 April 2021 by creating the new position of Chief Digital Transformation Officer (CDTO). With the appointment of Constanze Hufenbecher, we were able to secure the services of an excellent manager to take up this key role. Ms. Hufenbecher has extensive experience in the relevant fields, particularly with transformation management and the development and establishment of consistent processes across organizations. Ms. Hufenbecher has been very involved since taking office and is already an integral part of the Management Board team.

Furthermore, during the year under report, the Supervisory Board extended the mandate and service contract of Dr. Sven Schneider (CFO) by a further five years with effect from the end of his first term of office in April 2022. Over the past two-and-a-half years, Dr. Schneider has repeatedly demonstrated his wide-ranging capabilities, such as with the highly acclaimed refinancing concept he developed for the acquisition of Cypress. We are therefore extremely pleased that Dr. Schneider will remain with the Infineon Management Board as CFO in the long term.

With the mandate of Infineon's long-serving CEO Dr. Reinhard Ploss due to expire at the end of 2022, both the Executive Committee and the full Supervisory Board have been working on a suitable succession plan for some time now. During the fiscal year under report, the Supervisory Board engaged a well-known external personnel consultant who has helped create a role profile for the position of Chair of the Management Board.

Management Board remuneration

The new Management Board remuneration system decided upon by the Supervisory Board in November 2020 was approved by a large majority at the Annual General Meeting held in February 2021, and the new rules were fully incorporated into the service contracts of all Management Board members, effective 1 October 2021. Some of these rules were, however, already relevant for the 2021 fiscal year. In particular, the tranche allocated on 1 April 2021 (for the 2021 fiscal year) for the long-term incentive (LTI) variable remuneration component is already covered by the new remuneration regime. As in the previous system, the LTI continues to be based on a four-year performance period and is geared towards settlement in the form of shares. The target structure, however, has been significantly changed, the most notable difference being that it now includes ESG targets for the first time alongside financial targets.

› Firstly, the Supervisory Board has set a sustainability target derived from Infineon's strategic focus on sustainability. Infineon has long been one of the world's most sustainable companies and is a well-established member of the Dow Jones Sustainability Index. Among other things, Infineon has committed to becoming carbon-neutral by 2030. Forward-thinking corporate governance, ecological action and social commitment are indispensable prerequisites for Infineon's resilience and long-term corporate success. The current sustainability target is to achieve 50 per cent carbon neutrality by the end of the 2024 fiscal year.

› Secondly, the Supervisory Board has set a diversity target with a specific focus on gender diversity, namely to increase the proportion of women in management positions.

The changes relating to the short-term incentive (STI) variable remuneration component do not become relevant until the 2022 fiscal year. However, in view of the changes to be made to the STI going forward – including the introduction of a criteria-based modifier and the addition of the Segment Result Margin to financial targets – it was necessary to make some related decisions during the 2021 fiscal year. The purpose of the criteria-based modifier is to enable the Supervisory Board to assess the Management Board's collective performance as well as the impact of any extraordinary that were not adequately reflected in targets set at an earlier stage. The collective performance assessment is meant to reward the extent to which the Management Board in its entirety contributes to the sustainable development of the Company – in strategic, technical and structural terms. Prior to the beginning of each fiscal year, the Supervisory Board selects the criteria that it has determined are relevant for the fiscal year in question. At the recommendation of the Executive Committee, the Supervisory Board has defined two specific criteria for the 2022 fiscal year. Based on these criteria, the Management Board's performance will therefore be measured firstly in terms of its success in implementing Infineon's digital transformation strategy and secondly in terms of its ability to develop key technologies and innovative solutions or, expressed more specifically, by its ability to grow business with SiC and GaN products on this strategically important market for Infineon.

Further information on Management Board remuneration – particularly the amounts paid to individual members in or for the 2021 fiscal year – is available in the detailed remuneration report. [p. 132 ff.](#)

Litigation

The Supervisory Board was regularly provided with in-depth information regarding major legal disputes during the 2021 fiscal year, which it then discussed at length with the Management Board. These included, in particular, the appeal brought by Infineon before European courts (which has meanwhile been resolved) regarding an antitrust fine imposed by the EU Commission in 2014 and the related follow-up proceedings, as well as the legal dispute with the insolvency administrator of Qimonda AG pertaining to alleged residual liability claims, which has been ongoing for years.

Supervisory Board topics

Basic and ongoing training

Supervisory Board members are responsible for undertaking any basic and ongoing training measures considered necessary to perform their duties and receive appropriate support from Infineon to do so. In-house information events are held to provide targeted training as the need arises. As part of the onboarding process for new Supervisory Board members, Infineon offers a series of workshops covering a broad range of topics, including the individual operating segments, the underlying elements of Infineon's corporate strategy, the target business model and investment planning as well as manufacturing strategy and life cycle management. In addition, Supervisory Board members are regularly provided with information on the regulatory environment relevant to their work as well as any other legal developments that may affect them.

Committee work

The Supervisory Board's various committees are responsible for drawing up resolutions and preparing other major topics that need to be dealt with by the full Supervisory Board. Moreover, the Supervisory Board has delegated certain decision-making powers to its committees, to the extent permitted by German law. The chairpersons of each committee are required to report on committee meetings at the next relevant full Supervisory Board meeting.

Mediation Committee

The Mediation Committee did not need to convene during the 2021 fiscal year.

Nomination Committee

The Nomination Committee did not convene during the 2021 fiscal year.

Executive Committee

The Executive Committee faced a number of challenging tasks during the 2021 fiscal year and will continue to do so going forward. Over the twelve-month period under report, it was closely involved in implementing new requirements relating to Management Board and Supervisory Board remuneration as well as creating the new Management Board function responsible for digital transformation and appointing Ms. Hufenbecher to the post. In the course of the current fiscal year, the Supervisory Board will continue to deal with the topic of succession planning for the Management Board. In view of the workload involved, on 6 August 2021, the Supervisory Board resolved to temporarily enlarge the Executive Committee from four to six members until 30 September 2022 and therefore elected Ms. Engelfried and Ms. Suckale as new Committee members.

The Executive Committee held two ordinary and seven extraordinary meetings during the fiscal year under report.

At the ordinary meetings, the Executive Committee focused primarily on preparing the Supervisory Board's resolution to determine the level of variable remuneration to be paid to Management Board members. This included, firstly, determining the target achievement levels for the 2020 fiscal year and setting new target values for the 2021 fiscal year, and secondly – for the first time – determining the STI modifier criteria, confirming the ESG targets for limiting carbon emissions and increasing diversity relevant for the LTI, and confirming the composition of the TSR peer group.

In addition to remuneration matters, the main topic of the extraordinary meetings was the aforementioned succession planning for the Management Board.

Investment, Finance and Audit Committee

The Investment, Finance and Audit Committee convened for five ordinary meetings during the 2021 fiscal year.

Its activities centered on monitoring the financial reporting process, reviewing the half-year and quarterly financial statements, conducting the preliminary audit of the Separate Financial Statements, Consolidated Financial Statements and Combined Management Report for Infineon Technologies AG and the Infineon Group, and discussing the audit reports with the auditor. In addition, the Committee examined Infineon's financial and investment budget. It also received regular reports on the internal control, internal audit, risk management and compliance management systems and deliberated on their effectiveness. The Committee was also provided with continuous updates concerning significant legal disputes.

The Committee's recommendation to the full Supervisory Board to propose to shareholders at the Annual General Meeting that KPMG AG Wirtschaftsprüfungsgesellschaft, Munich, (KPMG) be elected as Company and Group auditor was based on a Declaration of Independence obtained from KPMG as well as an analysis of the non-audit services provided by KPMG. There were no indications of conflicts of interest, grounds for exclusion, or other lack of independence on the part of the auditor. The recommendation was also based on the Committee's confirmation that it is free from undue influence by third parties and that it has not been subject to any restriction regarding the selection of auditors within the meaning of section 16, paragraph 6 of the EU Statutory Audit Regulation. The Committee also considered the fee arrangements and issued contracts for the relevant audit engagements. Supplementary areas for audit emphasis were also defined.

The Act to Strengthen Financial Market Integrity (Finanzmarktintegritätsstärkungsgesetz – "FISG") – key parts of which came into force on 1 July 2021 – significantly restricts the permitted scope of non-audit services. Although these restrictions do

not apply to Infineon until the 2023 fiscal year, the Investment, Finance and Audit Committee has elected to comply with the new rules as of the 2022 fiscal year and accordingly resolved to reduce the scope of services that may be performed by the external auditor.

The representatives of the auditor attended all meetings of the Investment, Finance and Audit Committee and reported in detail on the audit procedures performed.

In light of the legal provisions governing the regular rotation of external auditors, the Investment, Finance and Audit Committee intensified its involvement with this topic and the corresponding requirements of the tender process.

The Committee also devoted time to considering the Group's Non-Financial Report and, in this context, took a close look at other sustainability issues, including the EU taxonomy.

One special topic that the Investment, Finance and Audit Committee dealt with during the 2021 fiscal year was the private placement of notes with a volume of US\$1.3 billion at very attractive conditions. The considerable over-subscription of the transaction was once again clear evidence of the confidence of capital markets in Infineon's economic prospects, underlining the Group's ability to access all relevant sources of funding. The placement has also improved the maturity profile of Infineon's debt and successfully rounds off the various capital market transactions undertaken during the past two years in conjunction with the refinancing of the acquisition of Cypress.

The high opinion in which Infineon is held by investors and analysts alike was also evident on the occasion of Capital Markets Day. This event took place most recently in 2018 and was again a great success when held in a virtual format at the beginning of October.

Strategy and Technology Committee

The Supervisory Board's Strategy and Technology Committee convened three times during the fiscal year under report. The topics covered included detailed reports it received from the Management Board regarding the current market situation, competitors, the headway being made in terms of synergies and the progress of integration following the acquisition of Cypress, as well as the annual strategy and technology plan. Other topics of focus included new technologies such as SiC and GaN, the long-term development of key markets, developments relating to software applications, and preparations for the Supervisory Board's Strategy Day. A new framework for future M&A activities was also discussed.

Supervisory Board remuneration

The changes to Supervisory Board remuneration, which were approved by a large majority at the Annual General Meeting held in February 2021, took effect at the beginning of the 2022 fiscal year, i.e., on 1 October 2021.

Corporate Governance

Declaration of Compliance 2021

In the Declaration of Compliance dated November 2021, the Management Board and the Supervisory Board jointly declared that all the recommendations of the German Corporate Governance Code (DCGK) contained in the version dated 16 December 2019 have been complied with and will continue to be complied with in the future.

The actual wording of the Declaration of Compliance 2021, as well as all previous Declarations of Compliance, are available on Infineon's website.

www.infineon.com/declaration-of-compliance

Self-assessment by the Supervisory Board

The Supervisory Board regularly assesses how effectively it, as a corporate body, and its related committees perform their duties. An internal self-assessment was performed in summer 2021, based primarily on a questionnaire, the results of which were discussed by the Supervisory Board. The next assessment is scheduled for 2022 and will be supported by an external consultant – as was the case most recently in 2017.

Examination of potential conflicts of interest

The members of the Management Board and the Supervisory Board are required to disclose any conflicts of interest to the Supervisory Board without delay. No situations occurred during the 2021 fiscal year involving conflicts of interest.

Prior to members of the Management Board assuming sideline activities, particularly supervisory board mandates outside the Company, the DCGK requires that permission be granted by the Supervisory Board. No conflicts of interest were discernible in any of the sideline activities performed. In fact, they were all in the best interest of Infineon.

Further information on the topic of corporate governance is available in the Statement on Corporate Governance, which also includes the Corporate Governance Report.

www.infineon.com/declaration-on-corporate-governance

Rules of procedure for the Supervisory Board and the Management Board

All rules of procedure are available on the Infineon website.

www.infineon.com/cms/en/about-infineon/investor/corporate-governance/articles-of-association/

Related party transactions

Publicly listed companies such as Infineon require the approval of the Supervisory Board or one of its committees before entering into certain transactions with related parties. In order to identify related party transactions that require approval and to treat them in compliance with the law, Infineon has implemented a procedure based on guidelines that apply across the Group. The Supervisory Board has delegated responsibility in this area to the Investment, Finance and Audit Committee, particularly for resolutions requiring approval. As in the previous fiscal year, there were no related party transactions requiring approval during the twelve-month period under report.

Act to Strengthen Financial Market Integrity (FISG)

The Act to Strengthen Financial Market Integrity (Finanzmarktintegritätsstärkungsgesetz – “FISG”), which for the most part came into force at the beginning of July 2021, has resulted in various regulatory changes, including some affecting the corporate governance of companies. Most of the new requirements now enacted in legislation had already been standard practice at Infineon for some time. For this reason, action was only needed in a few areas.

Section 109, paragraph 1, sentence 3 of the German Stock Corporation Act (Aktien-gesetz) now stipulates that the Management Board is generally not permitted to attend meetings of the Supervisory Board and its committees in the event that the auditor is called upon to attend these meetings as an expert, unless the Supervisory Board or the committee concerned deems the Management Board’s attendance to be necessary. The Supervisory Board is of the opinion that the attendance of the Management Board and its involvement in any discussions with the auditor is beneficial for all parties concerned, including the Supervisory Board and its committees in the performance of their (audit-related) activities, not least with regard to the specialized expertise of the Chief Financial Officer. The Supervisory Board therefore considers it necessary for the Management Board to continue attending such meetings in the future and until further notice, in particular the meetings of the Investment, Finance and Audit Committee as well as the meeting of the full Supervisory Board at which

the financial statements are deliberated upon. If a Supervisory Board or committee member wishes to discuss a particular matter with the auditor at a specific meeting without the Management Board being present, the Chairman of the Supervisory Board or relevant committee is required to take this request into account by dealing with the relevant agenda item either in full or temporarily without the presence of the Management Board.

In addition, the agendas of all Supervisory Board and committee meetings at which the auditor is either involved or (partially) present will in future include a discussion between the Supervisory Board and the auditor without the presence of the Management Board as a standard agenda item.

Separate and Consolidated Financial Statements

KPMG audited the Separate Financial Statements of Infineon Technologies AG and the Consolidated Financial Statements as of 30 September 2021, as well as the Combined Management Report for Infineon Technologies AG and the Infineon Group, and issued unqualified audit opinions thereon.

The Half-Year Financial Report was also reviewed by KPMG. No issues were identified that might indicate that the condensed Interim Group Financial Statements and Interim Group Management Report were not prepared in accordance with the applicable provisions in all material respects.

KPMG has audited the Separate Financial Statements of Infineon Technologies AG and the Consolidated Financial Statements of the Group and reviewed the Interim Financial Statements of the Group since the 1999 fiscal year (short fiscal year from 1 April 1999 to 30 September 1999). Mr. Pritzer, the auditor responsible for the engagement, signed the auditors’ report for the first time for the 2017 fiscal year (1 October 2016 to 30 September 2017), and Mr. Schmitt, as co-signatory, for the first time for the 2021 fiscal year (1 October 2020 to 30 September 2021).

At the meeting of the Investment, Finance and Audit Committee held on 8 November 2021 and continued in a conference call on 18 November 2021, thorough discussions were held with the auditor regarding the Separate Financial Statements, the Consolidated Financial Statements, the Combined Management Report, the appropriation of profit, and the auditor's findings. The Committee deliberated at length on the key audit matters as well as on the related audit procedures performed by the auditor. Based on the insights gained in the course of these deliberations, the Investment, Finance and Audit Committee resolved to suggest to the Supervisory Board that the financial statements drawn up and presented by the Management Board be approved and the proposed appropriation of profit agreed to.

The Separate Financial Statements, the Consolidated Financial Statements, the Combined Management Report, the Management Board's proposal for the appropriation of unappropriated profit (all prepared by the Management Board) and KPMG's long-form audit reports were all made available to the Supervisory Board at the meeting held on 25 November 2021. At this meeting, the Chairman of the Investment, Finance and Audit Committee reported in depth on the corresponding recommendations of the Committee. In addition, all material issues relevant to the financial statements and the audit, including key audit matters, were exhaustively discussed with the auditor and closely examined by the Supervisory Board. The examination also covered the proposal to pay a dividend of €0.27 per entitled share.

The Supervisory Board concluded that it has no objections to the financial statements and the audits performed by the auditor. In its opinion, the Combined Management Report complies with all legal requirements. The Supervisory Board also concurs with the assertions regarding Infineon's future development contained therein as well as with the results of the audit of the financial statements. It therefore approved the Separate Financial Statements of Infineon Technologies AG and the Consolidated Financial Statements of the Infineon Group for the 2021 fiscal year. The Separate Financial Statements were accordingly adopted. The Supervisory Board also approved the Management Board's proposal for the appropriation of unappropriated profit.

The Investment, Finance and Audit Committee and the full Supervisory Board also deliberated on the combined separate Non-Financial Report for the year ended 30 September 2021 drawn up by the Management Board. KPMG performed a "limited assurance" engagement for the report that was extended to a "reasonable assurance" engagement in regards to specific aspects. KPMG issued an unqualified opinion thereon. The documents were carefully examined by the Investment, Finance and Audit Committee at its meeting held on 8 November 2021, which was continued in a conference call on 18 November 2021, and by the Supervisory Board at its meeting held on 25 November 2021. The Supervisory Board positively acknowledged the combined separate Non-Financial Report drawn up by the Management Board.

The Supervisory Board wishes to thank the entire staff and the Management Board of Infineon once again for their tremendous commitment and outstanding achievements during a fiscal year that has been a challenging one in every respect.

Neubiberg, November 2021

On behalf of the
Supervisory Board



Dr. Wolfgang Eder
Chairman of the Supervisory Board

Business focus and strategy



Business focus

We want to continue to develop, grow and create value for our customers and our shareholders as well as for our employees and society. The coronavirus pandemic has put the brakes on for the moment but cannot stop us. On the contrary, the coronavirus pandemic has worked in some ways as a catalyst and accelerator of innovation. Many of the developments would have happened anyway, but the coronavirus pandemic has resulted in change being instigated much more rapidly or implemented more swiftly, especially with regard to the digitalization of society and the economy.

In the past few years, our strategy has been consistently guided by global megatrends that will continue to shape the world in the future: demographic and social change, climate change and scarce resources, urbanization, and digital transformation. From these megatrends, we derive our focus on the following growth areas: energy efficiency, mobility, security, and IoT and big data. In these markets, we address structural drivers: i.e., areas which are expected to see disproportionate growth in the long term as a result of these trends or which have major innovation potential. The coronavirus pandemic has not altered these underlying assumptions.

Demographic and social change

According to the United Nations, around 9.7 billion people will be living on Earth by 2050, two billion more than today. Population growth and the desire for a good life are two of the factors leading to an increase in energy consumption. This makes it necessary to produce, store, transmit and use energy more efficiently. Rising demand for resources is also pushing existing concepts for infrastructure, industry and communication to their limits. Microelectronics play a decisive role in supplying energy to the growing and evolving population and in creating sustainable spaces in which to live.

Climate change and scarce resources

Climate change has found its way into the public consciousness, and climate protection policies are being adopted in many parts of the world. Our actions have a significant impact on our environment. Efficient use of resources is therefore of fundamental importance. Developing energy-efficient products is one of the key elements in saving energy and tackling climate change. Our goal is to make “more from less”. Our semi-conductors feed renewable energy into electricity grids with minimum loss, reduce electricity consumption in computers, secure our digital data traffic, and power our cars in a more energy-efficient way. They make our everyday lives more comfortable, while at the same time minimizing the environmental impact of our energy consumption.

Urbanization

More and more people are crowding into the cities from rural areas. The coronavirus pandemic may interrupt this trend in the short term if at all. In the long term, major cities and metropolitan regions will continue to grow and act as magnets for migration, with the result that the trend towards urbanization will continue. Rapid urbanization places huge demands on infrastructure and on related services. How should a major city be designed in order to guarantee an adequate quality of life for everyone when

people are living in such close proximity? One possible solution is the “smart city” model. In the cities of the future, all aspects of public life will be intermeshed and connected with one another. This will also be true of suburban areas. An intelligent power grid (smart grid) can manage energy requirements efficiently. Sustainable mobility solutions like the smart car and expansion of the rail network will help manage the increasing volume of traffic. Digital and intelligent solutions in the smart home can also enhance the quality of life. Our products are our contribution towards advances in energy infrastructure, traffic and transportation systems and residential spaces. The objective is to make metropolises more efficient, greener, and more livable.

Digital transformation

Digitalization is permeating more and more areas of our lives and the coronavirus pandemic has accelerated this trend. New digital communication technologies have an impact on our everyday life, alter our lifestyle and give rise to new patterns of behavior. The digital transformation also allows for better use of resources. Resource use can be monitored and tracked and thus optimized. Meanwhile, humans and machines are producing enormous amounts of data. Big data is an extremely valuable raw material. People are revealing more and more sensitive information about themselves. This makes it necessary for users to be able to communicate with one another securely and without the risk of the misuse or theft of data. Safeguarding electronic devices and infrastructures thus takes the highest priority and makes the digital transformation possible. Meeting this increased need for security represents one of the core competencies of Infineon.



Growth drivers

Megatrends create new areas of growth

In each of the growth areas we address in the semiconductor market – energy efficiency, mobility, security, and IoT and big data – there are numerous application fields with high growth potential for our semiconductor business. Driven by increasing demand for energy and the setting of global carbon reduction goals, the need to generate, transmit,

store and use energy more efficiently is growing. Rising levels of traffic and transportation mean that sustainable, intelligent mobility solutions are crucial. The increasing digitalization of things enables energy to be used more efficiently. Electrification also requires more semiconductors in the end application, depending on the level of electrification. In a highly digitalized world, the number of interconnected objects increases and there is a rise in demand for secure processing, transmission and storage of data. Our solutions and systems serve all these application areas and help us achieve sustainable growth. In summary, Infineon is benefiting in equal measure from increasing electrification and from the digitization of end applications. [▶▶ C01](#)

C01 Our growth areas and growth drivers are derived from megatrends in society

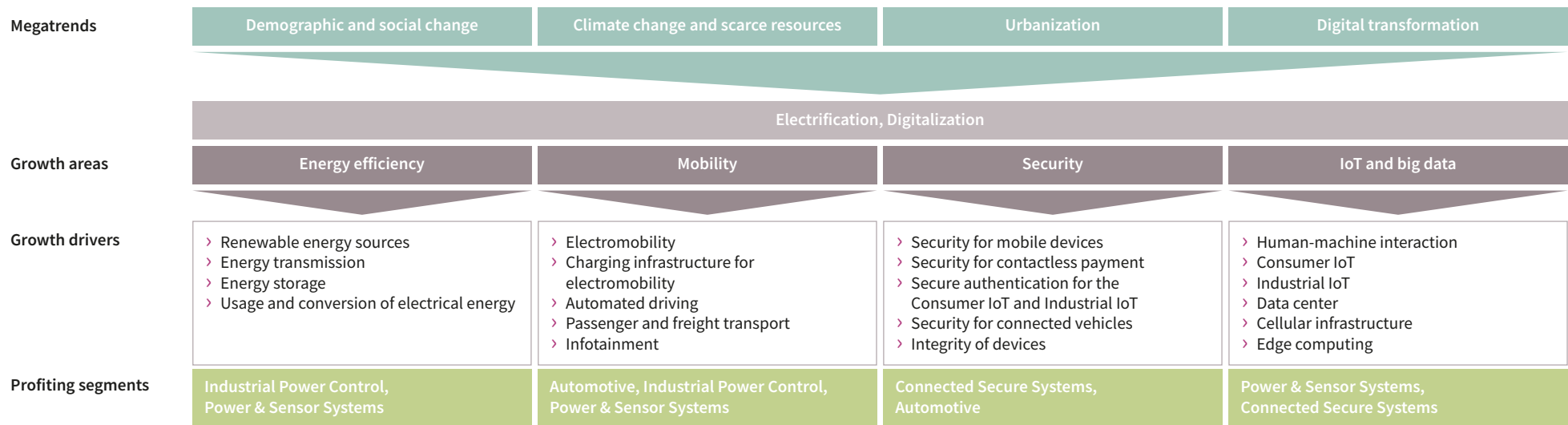

Infineon's growth areas are the source of its specific growth drivers

Energy efficiency

A new mindset on climate protection depends entirely on a new mindset on energy transformation. An energy transformation will only be viable if we take sustainable and climate-friendly action along the entire supply chain, from the generation of electricity to its consumption. Microelectronics play a decisive role here, helping to provide the growing population with energy in an efficient and environmentally friendly manner. For environmental reasons, it will no longer be possible in the future to meet the rising demand for electric energy by using fossil fuels to the same extent as we do today. Renewable energy sources, which do not emit carbon into the environment, are becoming more and more important. The use of wind power and solar energy is a key factor here. The fluctuating availability of energy from these sources can be balanced out by using electric storage systems but requires holistic management of the power grid.

Power generation from renewable energy sources

The renewable energy industry has been expanding fast for years and is gaining in importance as a result of the greenhouse gas reduction pledges made in various regions. According to estimates from the International Energy Agency, annual additions from renewables will need to more or less quadruple from their current figure of around 200 gigawatts by 2030, if the global goal of carbon neutrality is to be reached by 2050. Infineon benefits from the fact that wind turbines and photovoltaic (PV) power plants require multiple power semiconductors per gigawatt of electricity generated, compared with conventional power plants. In contrast to coal-fired, gas-fired and nuclear power plants, there is no turbine whose consistent movement can generate a constant alternating current of 50 or 60 hertz. Therefore, the electricity generated cannot be fed directly into the grid. Instead, power electronic systems are required for conversion and safeguarding. Infineon supplies all major manufacturers of wind power turbines and PV inverters.

Wind

When it comes to energy generation from wind, two trends in particular drive demand for semiconductors. First of all, older low-performance wind power turbines are being replaced by modern high-performance ones, a process referred to as repowering. Secondly, ever-stronger turbines are being used in initial installations. The performance of wind turbines has risen from around 100 kilowatts in the 1980s to present-day figures of up to 6 megawatts for onshore turbines and 14 megawatts for turbines in offshore wind farms. Depending on the type of wind turbine, semiconductors costing €2,000 to €3,500 per megawatt are required. Offshore wind farms in particular present major challenges in terms of the robustness and reliability of the components used, since they have to function in a harsh environment, at high humidity levels and in saline air over a long period, as well as needing to be low-maintenance.



Photovoltaics

In photovoltaics, Infineon has been cooperating for years with the world's leading manufacturers of PV inverters. Among other things, we are benefiting from the growth of Chinese inverter manufacturers, both with regard to domestic expansion of photovoltaics in China itself and to the export of PV inverters to other regions. We are also working closely with leading European and U.S. manufacturers. Efficient conversion and low system costs contribute to reducing electricity generation costs in open-space photovoltaic plants and to creating grid parity compared with conventionally generated electricity. Using our SiC transistors enables manufacturers of PV inverters to achieve better systems performance in terms of efficiency, size and cost when compared with Si-based solutions.

High-voltage direct current transmission (HVDC)

HVDC systems are playing a key role globally by providing reliable, low-loss energy transmission over long distances. They are also used for the grid connection of offshore wind farms. It is to be expected that future growth in the use of renewable energy will result in a rise in demand for efficient transmission routes. The semiconductor products for HVDC applications must satisfy particular requirements: robustness, short-circuit resistance and dynamic performance. We have developed an IGBT module- and a diode module-family specifically for this purpose.

Energy storage

As a result of the energy transformation, 50 percent of Europe's electricity should come from renewable energy by 2030. The use of renewable energy is linked with specific requirements for the entire energy supply chain. In contrast to conventional electricity generation, which takes place centrally in a small number of power plants, the generation of electricity from renewable energy takes place decentrally in a large number of small power plants. In addition, fluctuating power generation does not always match the demand. Conventional power plants still have to substitute for or supplement renewable energy sources. This makes the expansion of battery-based energy storage necessary in the long run. With its semiconductors, Infineon provides the essential power components and subsystems for efficient energy storage.

Hydrogen

Over the course of the next decade, hydrogen will play a crucial role in energy supply. However, if we are to exploit the potential of hydrogen, solutions must be found for the challenges associated with its production, storage, transportation and use. Semiconductor solutions from Infineon can provide significant support in the development of a sustainable hydrogen economy along the value chain.

Very high direct current (DC) is needed for the electrolysis process to produce green hydrogen. Alternating current (AC) supplied by the power grid must therefore first be converted into direct current. High system output (> 50 megawatts) can be achieved efficiently through the interaction of several high-performance switches. In conjunction with photovoltaic plants, there only needs to be an adjustment to the directly-generated DC in the electrolysis process. The combination of renewable energy and efficient power semiconductors is a key lever for the large-scale production of green hydrogen, which could become a major growth driver for Infineon. If one day green hydrogen is available in sufficient quantity and at a competitive cost, fuel cell technology will be used in various applications to generate electricity, for example, in the transportation sector (cars, trucks, buses, trains, helicopters, small aircraft) and as an alternative to diesel generators (on construction sites and campsites, for instance, and especially in base stations in remote areas and mountainous regions).



Green hydrogen from renewable energy is due to be produced at the Villach site (Austria) from the beginning of 2022.

Using electric energy

Power supply

A power supply for electric devices consists essentially of two stages. First, the power unit converts the grid alternating current (AC) into generally much lower direct current (DC), a process referred to as AC-DC conversion. The second step, depending on the intended usage, is for the voltage of this direct current to be adapted precisely at the point of load to suit actual requirements, such as those of a server's processors. This second stage is referred to as DC-DC conversion. The devices in question usually have several DC-DC converters. Growth in the area of power supply depends on the power and complexity of the devices and, above all, on an increase in the number of units.

AC-DC conversion

In the area of AC-DC conversion, we see high growth potential in the medium term in servers and telecommunications infrastructure. Power semiconductor demand and the number of servers are determined above all by the increasing complexity of the various systems and the growing demand for power which is the result. Demand for computing power and DRAM/Flash memory has been boosted substantially by the coronavirus pandemic. Working from home and mobile working, video streaming, social networking and, increasingly, machine learning will keep demand high. IoT and Industry 4.0 will accelerate this trend in the future. In addition, we see growth opportunities for our business in the following areas: compact chargers, fast-charging features and wireless charging solutions for smartphones, tablets and light laptops (portables).

> Wireless charging

The number of devices that can be charged wirelessly is constantly increasing. Wireless charging gives users the chance to charge their devices almost in passing, wherever they are, in the car, at home or in a public place. A charging station can also be used for the wireless recharging of several devices at a time. User acceptance will continue to increase as opportunities for fast charging grow. Wireless charging has advantages in terms of space and design, especially for small devices, as there is no need for a charging port. Following on from the smartphone, wireless charging will also apply to many other devices. Using electromagnetic fields, energy will be



transported from the charging station to the device and the battery will be recharged without requiring a physical connection.

> USB power delivery (USB PD)

USB ports are widely used around the world, for example, in laptops, vehicle cabins and planes, or in numerous public places as wall sockets. They are used primarily for the transmission of data but can also supply power to a limited extent to connected devices. The USB PD standard was created to increase significantly the maximum power that can be transmitted. Behind the standard lies the idea of a universal power supply for various devices, in which the power supply on offer is more flexible, while allowing data to be transmitted through a cable at the same time. This means that devices such as laptops, which require more power than a smartphone, can be supplied with power and charged via this interface. USB PD is on its way to becoming the new universal charging standard.

DC-DC conversion

As with AC-DC conversion, rising demand for more computing power and storage capacity is also driving demand for DC-DC converters. Special processors such as AI accelerators, FPGAs, ASICs and GPUs require high power at very low voltages. In addition, energy requirements change considerably depending on load and at extremely short notice. As a result, the electronic systems are supplied with higher voltages that are then precisely stepped down to the required low voltage directly in the processor. The same applies to PCs and communication devices, which sometimes require a large number of different voltages. This voltage conversion system is known as point of load. Requirements placed on dynamics, efficiency and stand-by consumption are increasing all the time. Customers are looking for simple, reliable high-performance solutions, necessitating the change to digital regulation of point of load systems and driving the trend towards all-in-one solutions.

Drives and automation

Electric drives are at the heart of a large number of systems, such as cranes, conveyor belts, automation systems and robots. We find them wherever something moves or is transported or cooled. Drives are also found in pumps, ventilators and compressors. According to the European Commission, electric motors account for almost 50 percent of the electricity consumed in Europe. Accordingly, there is great potential for savings if efficiency is improved. We provide our customers with all-in-one solutions for the efficient control of their electric motors, comprising microcontrollers, driver ICs, power switches and configuration software. These enable us to support fast times to market of our customers' products and to ensure their simple operation.



> Industrial automation

One way to reduce the energy consumption of an electric motor is to use an electronic control unit for speed control, which adapts performance to the load required at that time. Electronically controlled motors are also a key element in automation. Without them, it would be impossible to coordinate the various motion sequences efficiently. The market penetration of speed-controlled motors will increase. Such a motor control unit requires a large number of the power semiconductors we supply. The number and value of these power semiconductors depend on the power range of the motor. Industry 4.0 will trigger a new investment cycle, not only for automation in factories, but also for general transport and handling systems as well as for collaborative robots (see "IoT and big data" in this chapter, [p. 31 ff.](#)).

> Home appliances

Ever-stricter energy efficiency requirements are being imposed on home appliances. The new rules are intended, among other things, to create incentives to design products that are more efficient and have longer service lives. As a result, manufacturers of major home appliances are turning to highly-efficient motors with modern variable-speed control. These motors are significantly more energy-efficient, low-noise and have longer service lives. They are used, for example, in washing machines (drums and water pumps), dishwashers, refrigerators (compressors) and air-conditioning systems (fans, compressors).

> Battery-powered devices

In battery-powered devices, efficiency is particularly important, so that a battery



charge lasts as long as possible. As a result, more and more brushless direct current (BLDC) motors are being used. In BLDC motors, all the commutation (i.e., the polarity reversal of the direction of the current to produce electromagnetic fields) is electronic, depending on rotor position, rotor rotation speed and torque. This calls for appropriate power semiconductors and also, depending on the configuration, components for diagnostic and security functions. This type of motor requires high-performance electronic control units, compared with conventional electric motors. In addition to their high levels of energy efficiency, BLDC motors are particularly well-suited for use in battery-powered systems due to their low power-to-weight ratio. Examples include cordless home appliances such as robot vacuum cleaners, cordless screwdrivers and electronic lawnmowers. In addition to the electric motors, batteries are also becoming more and more efficient, enabling longer operating times, which is continuing to drive forward the transition from wired devices to battery-powered devices. Furthermore, all the examples cited also require additional power semiconductor components for the chargers. With battery-powered devices, we benefit both from unit growth and from the higher number of semiconductor components used.

Mobility

World population growth and increasingly global value chains as well as urbanization are driving demand for all types of transportation, ranging from mass transportation, such as trains and buses, to vehicles for private use, such as cars, eBikes and eScooters. Towns and cities in particular are confronted with the challenge of making transportation cheaper, more efficient and more sustainable.

Electromobility

The automotive industry is working continuously to reduce pollutant emissions. European Commission rules require, for example, a reduction in fleet average emissions from new cars to 81 grams of carbon per kilometer by 2025. The reduction target for 2030 is 59 grams of carbon per kilometer, a reduction of 37.5 percent compared with 95 grams of carbon per kilometer in the 2021 calendar year. This will increase demand for semiconductors. Optimization of the combustion engine is in itself no longer enough to fulfill legal requirements and to satisfy customer demand for sustainable mobility. Instead, systems consuming energy in the vehicle will increasingly have to be made more efficient, while hydraulic or mechanical solutions will need to be replaced by more efficient electromechanical systems based on semiconductors.

In order to reduce the fleet average to the mandated carbon target value, many vehicle manufacturers are expanding their product ranges to include models such as hybrid vehicles or pure electric vehicles. These have a significantly higher semiconductor content than conventional vehicles. Infineon offers a wide range of power semiconductor components for these vehicles. Of interest here is 48-volt technology, which is used in addition to the 12-volt onboard network. The vehicles that use this technology

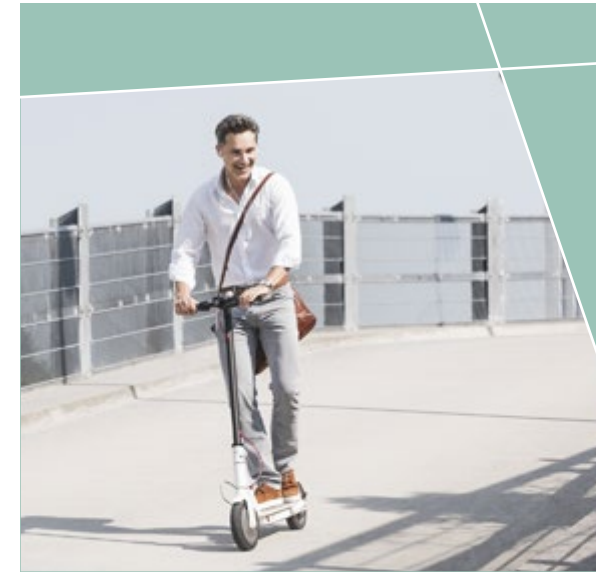

C02 Additional semiconductor demand per vehicle raised by electromobility in US\$

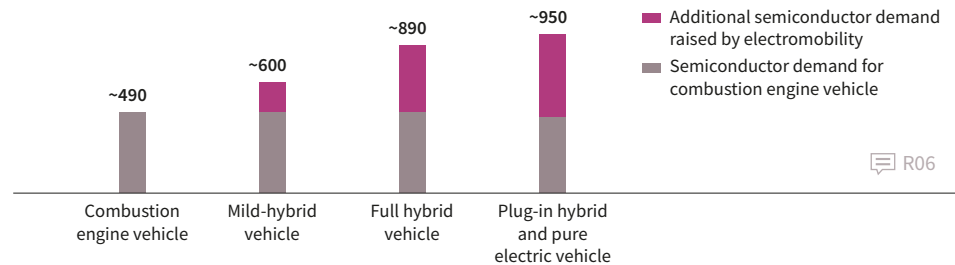

are known as mild-hybrid vehicles. On the one hand, this technology means that the vehicles can recover a certain amount of braking energy. On the other hand, pollutant emissions can be reduced by more efficient systems. Mechanical functions are increasingly being replaced by electric functions. The 48-volt part of the onboard network handles the power supply for high power consumers, such as the electric turbocharger, electric power steering and electronic stability control.

While the current average semiconductor content of a car with a conventional combustion engine is about US\$490, the amount in mild-hybrid vehicles is about US\$600, while for full hybrid vehicles it is about US\$890 and for plug-in hybrid as well as pure electric vehicles, it is about US\$950. Here, power semiconductors make up the vast majority of the additional semiconductor content per vehicle. **III C02**

Charging infrastructure for electromobility

The steadily increasing number of electric vehicles makes an appropriate charging infrastructure necessary. A well-developed network of charging stations increases the incentive to buy an electric vehicle. To promote acceptance of electromobility, most countries are continuing to expand their networks of publicly accessible charging stations. Depending on the system topology, the charging stations use different types of power semiconductors. SiC solutions are increasingly being used for ultra-fast charging stations which can deliver over 150 kilowatts of power.

Automated driving

“Vision Zero” describes one of the major objectives of the automotive industry, which is that vehicles should become so safe that there are no longer any serious or fatal accidents. Around 90 percent of such accidents today are attributable to human error. Active safety systems can either completely prevent an accident or at least significantly reduce its consequences by directly intervening in the driving process. Examples of such systems include pedestrian detection, adaptive cruise control and blind spot detection. Many of these functions are no longer reserved for luxury cars but have become standard features in mid-range vehicles.



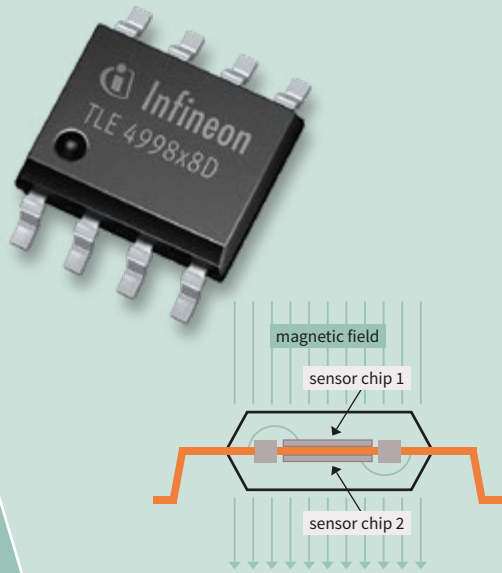

The Dual Hall Sensor TLE4998 includes two sensor ICs which are placed exactly on top of each other. This kind of redundancy is a basic requirement for highly dependable systems.

Active safety systems are increasingly developing into driver assistance systems. By supporting the driver with the tasks of driving, they increase both comfort and road safety. Among other things, they assist in critical situations or help correct a driver error where appropriate, for example, with automatic emergency braking maneuvers. The main systems for partially and fully automated driving comprise, firstly, sensors (such as exterior cameras, radar, and 3D ToF cameras for in-cabin surveillance), and secondly, a central high-performance computer to evaluate sensor data and determine the driving strategy (in a sense, the system's intelligence). The third element is additional secure memory IC solutions and the fourth is actuators (steering, brakes, engine control and transmission), while the fifth is a reliable power supply for all these control units, sensors, memories and actuators, ^{R07}. Our competence in providing solutions illustrates the potential edge computing holds for us.

A high degree of reliability is required for driver assistance systems in vehicles. Unlike humans, they are expected to be 100 percent reliable. Functional safety and the quality of products, software and systems are therefore very important, placing challenges on the whole industry. For Infineon, this falls under the umbrella of reliability or “dependability” and the Company has a significant competitive lead in this field.

Transport of people and goods

Sustainable and optimally networked mobility within metropolitan areas as well as between large cities is one of the key topics of the 21st century. Today more than ever, rapid and reliable public transportation determines the quality of life in many regions and cities worldwide and the ability of those regions and cities to compete with others. The trend towards electric trains has been with us for some time and is set to continue. Our components (mainly power semiconductors, but also microcontrollers and sensors) are used not only in local passenger trains, metro trains and trams, but also in high-speed trains. Moreover, electrification is becoming increasingly common for the locomotives of freight trains, as well as for buses, trucks, construction equipment and farm machinery. Power electronics also play a key role here.



Security

The increasing degree of interconnection between humans, machines and devices demands greater IT security: from the manufacturing industry and smart home applications to information and communication technologies. We provide our customers with robust, future-oriented embedded security hardware for electronic devices, computer systems, network components and industrial facilities. These security technologies make it possible to authenticate people and machines, protect confidential data and detect unauthorized changes to networked machines and devices. In industry, this trend is already evident. With increasing digitalization, the desire for reliable IT security that is also easy to use is growing.

Security for mobile devices

The development of smartphones and wearables, the mobile internet and Near Field Communication (NFC) technology has made it possible to integrate payment services into today's mobile devices.

During the coronavirus pandemic, people have particularly valued this function. However, cashless payment is just one of many of the functions of mobile devices requiring the storage and processing of sensitive data. Travelers on public transportation, for example, enjoy the convenience of using mobile tickets instead of coins or physical tickets. These applications require special security solutions such as a security chip called a Secure Element (SE). The SE can either be built into the smartphone (when it is referred to as an embedded SE, or eSE) or integrated into the SIM card.



Security for contactless payment

Contactless payment has been common for several years in many countries and regions, such as the U.S. and Canada, and Europe, but also Asia, especially China and Singapore. The coronavirus pandemic ensured greater acceptance of this type of payment, even in previously hesitant countries such as Germany. Behind contactless payment transactions, there is generally a transmission standard that transmits the data over a short distance of four centimeters at the most. This small range, in conjunction with encrypted data transmission, makes contactless payment transactions secure. Infineon is one of the world's largest manufacturers of security chips and antennae for payment cards.

Secure authentication for the IoT

Security plays a key role in IoT. The rising number of hacking attacks underlines the need for appropriate precautions. In order to secure electronic systems, it is important to connect only authorized and authenticated devices with each other and to protect them against manipulation and cyber-attacks. This means that security must be integrated into every end-point whenever possible. The electronic components central to security are typically assembled on the printed circuit board, which is why these components are referred to as embedded security. Infineon offers various embedded security controller families adapted to meet specific security requirements.

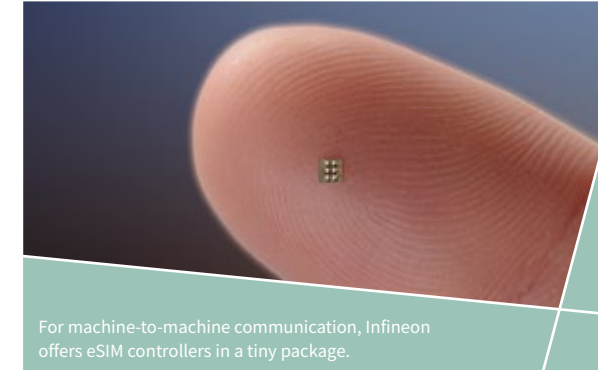

For machine-to-machine communication, Infineon offers eSIM controllers in a tiny package.

Security for industrial applications (smart factories)

In the era of Industry 4.0, companies are using the latest technologies to make their manufacturing faster and more cost-effective, to reduce rejection rates and to minimize

disruptions and downtime through predictive maintenance. However, the networking and digitalization of factories create points of attack for hackers. To protect themselves, companies must therefore take security into account from the very beginning of Industry 4.0 projects. A combination of software-based and hardware-based security solutions can protect connected machines and communication nodes. Examples are OPTIGA™ TPM chips from Infineon, which can be integrated into routers, industrial PCs or complex control units and which serve to identify devices to communicating partners in the network. They thus authenticate themselves in the network while securing transmission of the data. At the same time, they also help protect the devices against manipulation, for example by helping to secure software updates. They act in a way like vaults for the encryption certificates.

Security for connected vehicles

The ever-increasing connectedness of vehicles creates opportunities for many new services but also carries the risk of unauthorized access. This makes it necessary to guarantee the secure exchange of data both between the various onboard systems and with other vehicles and the infrastructure. Vehicle safety and personal safety, on the one hand, and data security and IT security, on the other hand, can no longer be considered in isolation from each other. The vehicle is becoming a networked computer on four wheels and part of the IoT. The demand for data security and IT security in the vehicle is rising. We see our opportunity here in the hardware-based security provided by our security controllers – either as a separate component or integrated into our automotive microcontrollers.

Integrity of devices

The integrity of devices has to be ensured as they become increasingly interconnected. In principle, this means that no unauthorized modifications can be made to programs and data by third parties. A Trusted Platform Module (TPM) can be implemented here. This special security chip can protect keys, passwords and digital certificates and store them separately from the CPU. In this way, sensitive information and security-critical data are locked away in a “data vault”. At the same time, the integrity of the data can be checked, making it possible to detect attacks promptly and ensure the correct functioning of a system.

IoT and big data

IoT connects the real world and the digital world. A wide variety of physical things – ranging from smartphones, watches and cameras to cars and computers and even to home appliances and industrial machinery – are equipped with embedded electronic systems, sensors and software. The possibilities are huge: greater convenience and security in the smart home, higher productivity together with better ecology in farming, greater productivity in manufacturing, new services, and support for older people. These examples show that IoT has the potential to effect radical change in the interaction not only between companies and consumers, but also between companies as well as between consumers.



Our semiconductor solutions drive the IoT. Sensors record mostly analog information from their surroundings and transform it into digital data. Then microcontrollers process this data and generate control signals, actuators convert the control signals into actions (in most cases motion, but also light or heat) and security solutions protect the integrity of devices and data, while connectivity chips are the link between the real world (the end device) and the digital world (the digital twin in the cloud).

Human-machine interaction

Human-machine interaction is concerned with how humans and systems interact and communicate with each other. For a long time now, the focus has no longer been on traditional industrial machines but on computers, digital systems or IoT devices: i.e., the connection between the real world and the digital world. More and more devices are connected and perform their tasks automatically. The operation of all these machines, systems and devices has to be as intuitive as possible, as if the user were communicating with a human.

C03 We are linking the real and the digital world

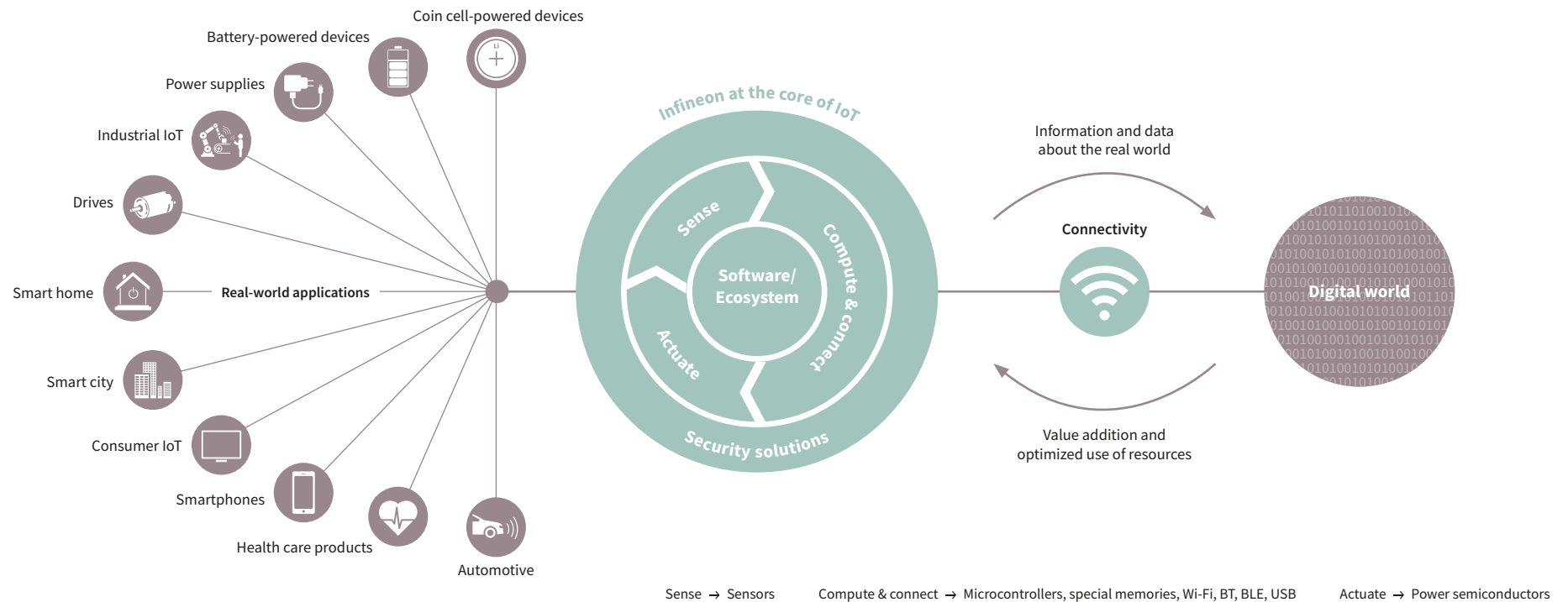

Wearables

Wearables are continuing to offer new innovative functions, such as health and fitness monitoring. They are practical and comfortable to wear and can, depending on the application, be used for a variety of purposes. Factors to consider in the design of a wearable are size, comfort for the wearer and ease of use. Other success factors are accuracy of measurement, a long service life, stability, and security functions. Our products and system solutions fulfill these requirements. Small energy-saving sensors enable, for example, high-quality monitoring of health, physical movement and sporting activities. Our radio frequency solutions support connectivity and location tracking. Our solutions for wireless charging also make it easier for the user to recharge the devices. As wearables collect user data about health, a high level of data security is essential in order to protect the user's privacy.

Collaborative robots

The area of robotics has been attracting great attention for some years. In addition to the continuing development of conventional industrial robots, more and more areas of industry are using collaborative robots (cobots). Cobots work together with humans in the manufacturing process and are no longer separated from their human colleagues by protective equipment like typical industrial robots. They are therefore required to meet high standards of safety and reliability, as they have to be able to perceive their surroundings well enough to work effectively together with humans without endangering them. Cobots will be able to relieve and support humans performing hard and dangerous tasks. In the long term, cobots will also support elderly people in living independent lives, helping to solve the challenge of an aging population. As cobots develop, the trend will be towards intuitive robot programming and self-learning robots. Infineon offers not only the necessary sensors, microcontrollers, connectivity solutions, power semiconductors and security solutions, but also provides numerous start-ups in this market with knowhow in the areas of motor control, sensor systems and security.



Smart home

“Smartification” is also happening in the home and involves the use of pioneering technology to make our daily lives easier and more convenient. Today's growing range of technologies includes home appliances and interconnected mobile devices. To be “smart” in this sense, these devices and systems need to be equipped with the right semiconductor solutions. These enable smart devices to perceive their surroundings and to adapt to changing situations through connectivity. Sensors, control units and actuators enable real-time data to be properly captured, interpreted and processed and for the appropriate action and/or reaction to be triggered. In times of increasing connectivity, cyber-attacks present a security risk that can be reduced by including security solutions as an integral part of the devices.

Smart buildings

Smart buildings improve the comfort of their occupants and are set to become an integral part of the energy transformation. According to the German Federal Ministry for Economic Affairs and Energy, buildings are currently responsible for around 35 percent of Germany's energy consumption. By 2050, however, the Federal Government wants to reduce the energy requirements of its building stock by 80 percent. That goal could be achieved if smart buildings were to generate their own electricity (using solar systems, for example, as part of a smart grid) and, at the same time, were much more energy-efficient than conventional buildings. They can, for example, use sensors to



detect how many people are in a room at a particular time and, based on that information, automatically regulate the lighting or heating. Maintenance costs are also reduced. Sensors that measure and monitor the condition of components are included in the building installations, such as elevators. If there is the risk of a defect as a result of wear and tear, technicians are notified. They then carry out predictive maintenance before the elevator breaks down. Expensive outages can thus be avoided. Last but not least, smart buildings improve safety. If there is a fire in the building, sensors are able to detect how the smoke is spreading, enabling escape routes to be identified.

Industrial Internet of Things (IIoT)

The IIoT describes the digital transformation of industrial production. Sensors, microcontrollers and actuators make machines smarter. They can monitor themselves and their surroundings and optimize their actions. In manufacturing, machines are connected with each other to form an intelligent network that enables comprehensive optimization of processes, material flow and capacity utilization. This makes the

supply chain and manufacturing more efficient. By involving customers and suppliers, demand-related changes in capacity utilization or a breakdown in the supply chain can be offset faster. Predictive maintenance means that expensive machine downtime can be avoided. Infineon is both a user and provider of IIoT solutions. We supply microcontrollers, sensors and security solutions for smart factories. At the same time, we have adopted Industry 4.0 approaches to a great extent at our own manufacturing sites.

5G mobile communications infrastructure

The advent of the new 5G mobile communications standard has greatly increased potential applications when compared with previous standards. Above all, 5G's high data transmission rates and considerably shorter reaction times and/or response times make new applications and devices possible. Network providers are continuing to expand their 5G infrastructure so that they are prepared for the increase in data volume and can offer their customers good network coverage. The network architecture has to migrate to smaller and more numerous cell sites to enable better exploitation of the available frequency spectrum and especially the use of higher frequency ranges. Our radio frequency components are used for communication between mobile devices and/or edge computing end devices (see next paragraph) and the base station, as well as for wireless backhaul from local networks to the core network.

Edge computing

IoT and the related explosive growth in devices with an internet connection, as well as other new applications that require real-time computing, will drive the growth in edge computing systems. In edge computing, data are processed where they arise, on the edge of a network. They do not first need to be sent to a central computer server, the cloud. This means that edge devices need to have sufficient capacity. High levels of capacity combined with limited system resources and energy budget require optimized concepts. This is where our products and systems come into play, for example, microcontrollers, power semiconductors and sensors, as well as connectivity ICs and security ICs. Our hardware, algorithms and system solutions are optimized for these tasks.

Group strategy

In recent years, we have established a stable foundation for success in our target markets. Our strategy is to further strengthen our core business and tap into new growth markets. We have built up and systematically expanded the technical expertise required over many years. Since good ideas do not turn into innovations until they are successful in the market, we have also developed the right concepts for implementing our value-creation strategy. [III C04](#)



At the heart of our implementation is our strategic approach “Product to System”, through which we focus our entire value chain on achieving success for the customer. This approach is supported by other elements: a broad-based culture of innovation, constant pursuit of technology leadership, a high level of quality awareness, in-house production that differentiates us from our competitors, and a sales and marketing strategy tailored to the various markets. We are therefore able to offer our customers leading products with the highest quality and delivery reliability, enabling us to achieve profitable growth and grow faster than the market. All this promotes our goal of achieving and securing a leading position in the markets and applications we are active in, while successfully addressing issues relating to the future.

Since the end of the 2020 calendar year, the semiconductor industry has experienced an unprecedented global shortage of manufacturing capacity. There were, and in some cases still are, many factors contributing to this shortage. In the December quarter, economic recovery began sooner and faster than expected. In geographical terms, this was the case, especially in China. In terms of industries, the bounce back was strongest in the automotive industry. The digitalization push caused by the coronavirus pandemic led to a surge in demand. Lockdowns in some countries (i.e., Malaysia), extreme climate situations (the winter storm in Texas, water scarcity in Taiwan), accidents (the fire in a semiconductor factory in Japan), disruption to the logistics chain (the tanker accident in the Suez Canal, a shortage of air and sea freight capacity) and, last but not least, ongoing political tensions greatly slowed production. Our strategy of engaging in differentiating in-house production, on the one hand, and outsourcing products based on standard manufacturing technologies to contract manufacturers, on the other, has proved successful. We will continue to adopt this strategy, making adjustments where necessary.

Within these strategic guidelines, the acquisition of Cypress that we completed in the 2020 fiscal year is enabling us to grow faster than we would have done organically. By combining complementary product portfolios, we are strengthening and expanding our core business and can service an even wider range of applications. We also offer our customers comprehensive system solutions and better performance and ensure a faster time to market for their products. These are the ways in which we differentiate ourselves and increase our growth potential.

Thinking and acting responsibly over the long term goes beyond our direct business. It is also crucial that, in addition to developing a greater understanding of our customers’ systems, optimizing our products and solutions, and achieving an adequate return in line with our objectives, we incorporate sustainability into the management of our business and engage responsibly with society. Making life greener is part of our mission. Therefore, we have set ourselves the target of becoming carbon-neutral by 2030.

Strategic guideline: Strengthening our core business and tapping into new growth markets

With our strategic focus on the megatrends referred to above, we are ensuring long-term growth for Infineon. We concentrate on markets with strong structural growth, especially on electromobility, the various stages of the electric energy supply chain and the increasing digitalization of all aspects of life. The way we act in the individual markets depends on our competitive position, which we analyze in terms of technologies, products and application understanding. Here we look at three categories: firstly, our core business; secondly, adjacent complementary business; and thirdly, new options for products and applications as well as for markets. [III C04](#)

Our core business includes all those areas in which we have a full understanding of the applications or where we master the underlying technologies and in which we can therefore offer an extensive differentiating product portfolio. In our core business, we want at least to grow with the market and thereby maintain or even strengthen our leading positions (“grow in scale”). One example is our power semiconductors, which are employed in the generation, transmission, storage and use of electric power.

C04 Strategic growth model

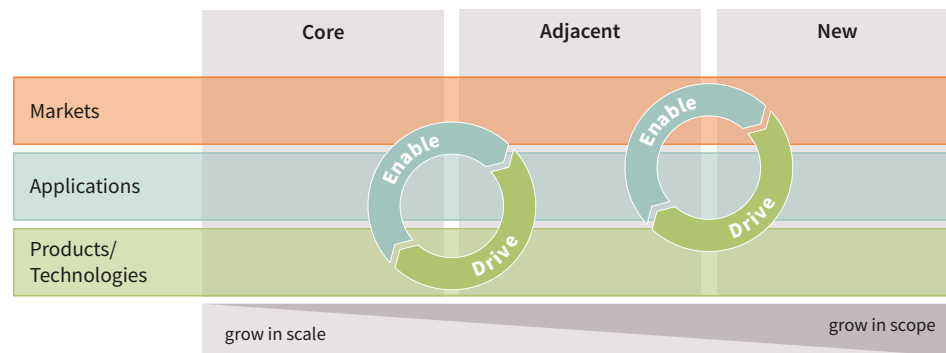

C05 Worldwide discrete power semiconductors and modules market share in the 2020 calendar year

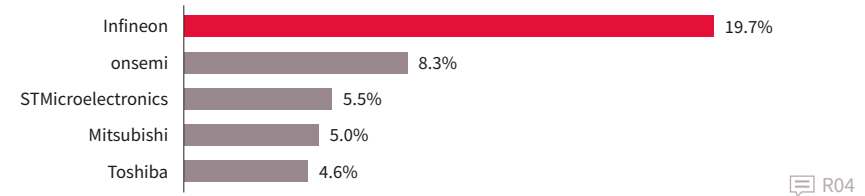

We understand how these systems are used to convert and control electric power, and we supply particularly compact and energy-efficient MOSFETs and IGBTs for this purpose. We are the undisputed global market leader in this area. [III C05](#)

We began researching new materials for power semiconductors at an early stage. SiC and GaN are particularly well suited for use in power electronics. Here, we are moving towards new levels of performance and efficiency. These components are typically more expensive than Si-based products, but thanks to new system architectures they also offer the customer multidimensional additional benefits, such as a smaller form factor, greater efficiency and lower system costs. Realizing these benefits often goes hand in hand with higher research and development costs for our customers. Therefore, we support the introduction of these new technologies in two ways. On the one hand, we work closely together with our highly innovative customers, while, on the other hand, we provide less technology-oriented customers with appropriate solutions that make the switch easy to implement, for example, compatible control components. Given the increasing relevance of SiC for certain power semiconductor applications, we acquired SiC specialist Siltecta in 2018. The company has developed an innovative method known as Cold Split technology to process crystal efficiently and with minimum loss of material, [III C06](#). Infineon will use the Cold Split technology for the efficient separation of SiC boules and to split SiC wafers. That gives us two advantages. Firstly, we can manufacture in a more cost-effective manner, as we use the raw materials more efficiently. Secondly, we achieve a higher

output of SiC components from the raw materials purchased, which increases our security of supply. This is particularly important given the ongoing expansion of renewable energy and the increasing use of SiC in the powertrain of electric vehicles. We have now established all the prerequisites for future success in the growing SiC market: access to high-quality wafers, leading technology at the product level (Trench SiC MOSFET), module expertise and system understanding.

C06 Siltrectra's Cold Split technology allows splitting of SiC boules as well as SiC wafers with minimum loss of material

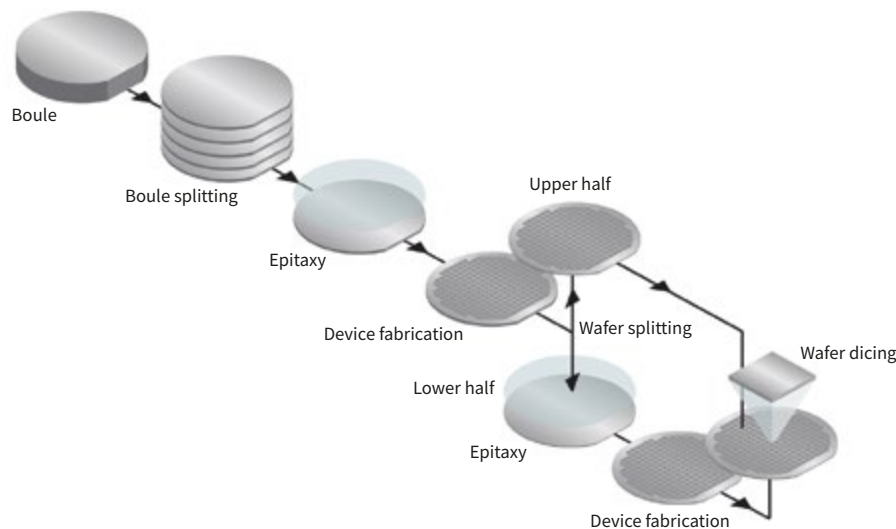

Accordingly, we offer our customers optimal solutions, and we can show them new ways of being successful. Our high-volume manufacturing means that we can achieve economies of scale, while at the same time, we can provide manufacturing capacity for individual customer projects and grow alongside our customers.

The greatest growth potential is to be found in markets adjacent to our core business that we have not yet addressed at all or in which we have only been partly active. It only takes a moderate amount of effort to adapt existing technologies and products for additional applications, enabling us to increase potential sales. In the application fields where we are already active, we can use our system understanding to increase revenue with a broader portfolio of products and solutions (“grow in scope”). The core mentioned above should therefore not be seen as a static portfolio of activities. Instead, the adjacent business becomes part of our core business in the medium term, the core grows and the boundaries shift, because when we make progress in specific markets in terms of technology, products and application understanding, the classification of these markets changes accordingly. To return to the example of power semiconductors, “Power” is one of our original core competencies, but here too we continue to develop. We are expanding our portfolio so that we can offer our customers an increasing degree of “Intelligence” in addition to power semiconductors. Specifically, this means that we have focused on complementing our range of efficient power transistors with additional components, increasingly using digital solutions. The products required for intelligent control of switches tend to be more complex and higher-end because they incorporate greater functionality. In the context of increasingly complex systems and shorter development times, many customers appreciate this greatly, as it enables them to reduce their development costs and development risk significantly.

Technological progress also paves the way for completely new application areas for which commercialization has not yet started on a wide scale. Sometimes innovations in semiconductor technology provide the momentum for new applications, while

other times groundbreaking concepts on the customer side require the development of suitable semiconductor solutions. By becoming involved in these new business areas at an early stage, we want to secure a good starting position in highly promising future markets. Take the example of smart buildings. Sensors are the sensing organs of a building. They actively perceive their surroundings by “hearing”, “seeing”, “smelling” and “feeling”. With our sensors, we can open up new application fields, such as predictive maintenance of smart buildings. To identify system failures, such as in an air-conditioning system, before they occur, our sensors measure various parameters and data points. These measurements provide information about whether the relevant system is operating properly or whether it might break down soon. The ability to monitor the state of these devices and systems and to predict outages before they actually occur, and to avoid the need to replace devices or systems too early, means that smart buildings offer significant potential for cost savings and greater convenience for their occupants. Intelligent control and monitoring of systems can of course also be used in many other areas, especially in industry.

We will continue to supplement our organic growth in the future with selective acquisitions. These acquisitions will need to fulfill three criteria: a) strategically beneficial across our three growth categories (core business, adjacent business, new options), b) financially advantageous and c) a good cultural fit. A purchase must strengthen Infineon’s market position in accordance with our strategic focus, usefully complementing our range of competencies. The corporate culture of any potential acquisition target must be a good fit with Infineon’s culture, or at least add valuable elements.

We applied these very criteria to the acquisition of Cypress, which was a major groundbreaking step in Infineon’s strategic approach. By combining complementary product portfolios, we are strengthening and broadening our core business in power semiconductors and are able to service an even wider range of applications. Our focus on structural growth drivers has been reinforced as a result and the base of our business model widened. Cypress has an extensive portfolio of microcontrollers, software and connectivity components. By combining these with our power semiconductors, sensors and security solutions, we are able to offer our customers

even more extensive and forward-looking system solutions. The synthesis of our security expertise and Cypress’ connectivity knowhow is accelerating our entry into new applications in the area of IoT. In the field of automotive semiconductors, the expanded portfolio of microcontrollers and NOR Flash memory ICs offers great potential, especially given their growing importance for driver assistance systems, new electronic architectures and haptic operating elements. The complementary nature of our product ranges means that we can differentiate ourselves even more strongly from the competition in our core applications with our strategic approach “Product to System” and we can thus service adjacent business areas. After the acquisition of Cypress Infineon is among the world’s top-10 semiconductor manufacturers, [IIL C07](#). The advantage of our system solutions to the customer is that the relevant parts come from a single source. They are compatible with each other and rounded off with software solutions. For our customers, this means shorter product development times and an attractive cost-benefit ratio for their products.

C07 Market share in the total semiconductor market in the 2020 calendar year
US\$473.491 billion market size

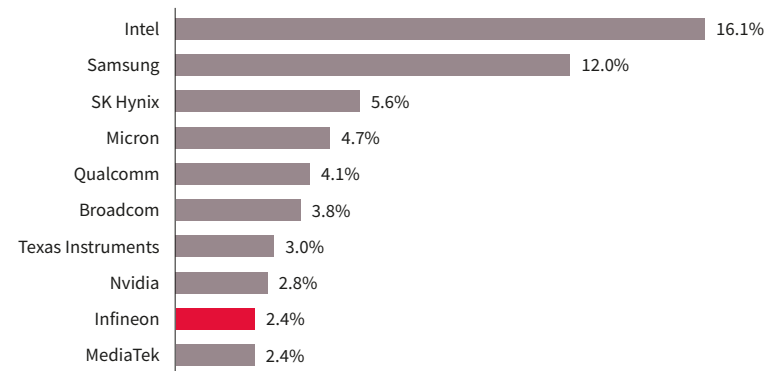

R01

Strategic action areas: Factors for successful implementation

Our strategic approach “Product to System” shapes our actions

Our strategic approach “Product to System” goes well beyond thinking in terms of technologies and products, **III C08**. This approach was also a key element in developing the strategic guideline on strengthening our core business and tapping into new and adjacent growth markets described above. We want to understand what the markets are demanding and how they are changing. Only then will we be able to understand how we in turn can change the markets ourselves. We therefore look not only at the direct sales opportunities for our products, but also at our customers’ success factors and at trends in the end markets. We want to recognize at an early stage when the foundation of our business is changing. Only then can we take appropriate action in good time, ensure sustainable differentiation in growth applications and increase earnings. For this to succeed, we have to understand the environment in which our customers’ products are used, how these products are embedded in larger systems, with which other devices the products interact, what requirements they have to fulfill and what function they are intended to perform. Looking at our products in these systems, we have to consider which other active and passive components and control concepts they use and what capabilities our customers contribute to the value creation process. Equipped with this knowledge, we can make the most of our competencies. We want to translate the technologically possible into marketable products that provide the greatest possible benefit to our customers. Sensor systems, for example, not only capture information about their surroundings, but also interpret and process the data they gather in order to initiate a particular action. Digital control loops in power supplies enable higher energy efficiency at both high and low load levels. Connectivity enables devices to be networked. Security controllers must be capable of distinguishing between authorized and unauthorized access. In all cases, in addition to the hardware components involved, software is also required to a greater or lesser extent. System understanding therefore also means software understanding.

As the range of services provided is increasingly becoming a differentiating factor, we have expanded our range to include an ecosystem. For many small customers without expertise in mounting semiconductor components, an ecosystem offers crucial value added, as it can significantly reduce their development time.

The basic idea is that we continue to expand our competence portfolio, thereby increasing our potential for differentiation and helping shape semiconductor trends. Best of all, however, is always to be one step ahead. Technology knowhow has invariably been the foundation of our business model, whether in the form of discrete components, integrated solutions or products that combine analog and digital functionality. Our broad portfolio ranges from individual components to solutions with basic firmware and driver software. This enables us to provide targeted support

C08 System knowhow and services are becoming more and more a differentiating factor

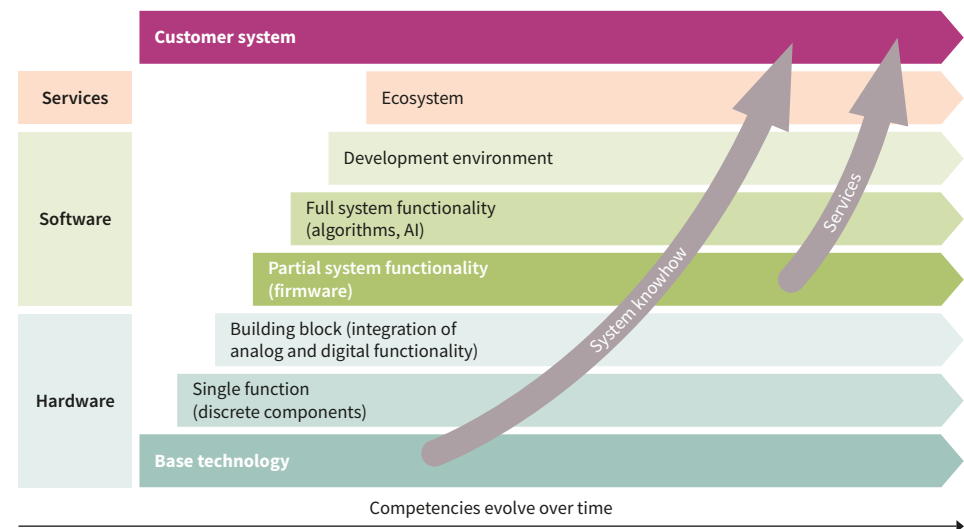

to our customers using totally different approaches. Some customers want to differentiate themselves from their competitors by using their own software, purchasing only the necessary hardware from us. We go one step further with automotive microcontrollers and security controllers, which we supply with special firmware that supports the basic functionality of the hardware and cannot be modified. More extensive functions can then be implemented using additional program code. The second generation of our iMOTION™ digital motor control platform was developed, for example, for use in home appliances and comes with a development kit as standard that reflects the priorities of our customers in this market: lower system costs, compact design, reduced development costs, short development time and a high level of reliability. The iMOTION™ components already contain all the algorithms required to control an electric motor. Only a small number of application-specific parameters need to be defined in order to complete the programming. Since we think in terms of systems, we

can support all these different approaches and understand how to create added value. To generate even more of it for our digital-age customers, we have expanded the iMOTION™ platform to include security and connectivity components. It is not always the most sophisticated solution that provides the greatest added value for the customer. Sometimes standard components may be the right fit. Nevertheless, system understanding creates a competitive advantage, because it gives us the ability to cooperate with our customers and develop better products.

In recent years, we have intensified our activities in the area of software, not only in strategic partnerships and our own software development, but also as a result of the acquisition of Cypress. The acquisition means that now, for the first time, we have an entire ecosystem comprising software components and a development environment, as well as reference designs, product support, blogs, a developer community and

online tutorials. A key element of this successful ecosystem is the ModusToolbox™ development environment. This includes reusable firmware that makes it significantly easier for engineers to program microcontrollers and Wi-Fi and Bluetooth components. The next step is to expand AI functionality: ModusToolbox™ Machine Learning with access to algorithms for implementation in microcontrollers.

In the area of software, we are also making considerable progress, which is benefiting our customers. We are combining our expertise in software with our hardware expertise. The second generation of our successful automotive microcontroller family AURIX™ can, for example, be used for radar signal pre-processing in combination with our radar sensor ICs. We have implemented this digital pre-processing of data in hardware, as this is considerably more effective. However, we were only able to do this because we mastered and integrated the underlying algorithms.

Technology leadership creates added value for customers

In accordance with our strategic approach of thinking in systems, our engineers anticipate many challenges before our customers are affected by them. This enables us to fulfill the promise of technological leadership. By cooperating closely with our customers, we learn to understand applications better. Thus we can identify future trends at an early stage, then develop products and tailor them accordingly. In this way, we can offer our customers individual components as well as complete system solutions as required.

We systematically use our strong technological position to expand our expertise, strengthen our core business and grow in scope, for example, whenever the requirements of our markets change or when we see long-term growth potential in an adjacent business area. As one of the market leaders in the field of power electronics, we began researching new materials at an early stage, building up our expertise, and we are constantly broadening our product portfolio. In the future, we will also continue to strengthen our expertise in the control of power semiconductors and to broaden our product portfolio. As the number one in MOSFETs and IGBTs, we see interesting opportunities for faster growth in this adjacent area than has been seen to date.



The iMOTION™ IMD11T6 is a highly-integrated IC for the control of 3-phase BLDC motors.

Many years ago, we deliberately blazed new trails in the field of sensor technologies, in the knowledge that capturing environmental data would become massively more important in our target markets. Today we have a comprehensive portfolio of sensors for a wide variety of systems in vehicles, for mobile devices, in consumer electronics and for the IoT. MEMS microphones in particular are experiencing a boom, not only in the field of traditional audio applications. In a vehicle, they support driver assistance systems by warning of approaching emergency vehicles with sirens sounding.

Another example is CO₂ sensors for buildings. Here energy efficiency standards require thicker insulation, which tends to lead to poorer air quality in the building. In the 2021 fiscal year, we launched our first CO₂ sensor able to detect an increase in carbon concentration. Compared to conventional CO₂ sensors, ours has a much smaller form factor, which opens up new areas of application, such as IoT devices and smart home applications to improve indoor air quality like air purifiers, thermostats, weather stations and personal assistants.

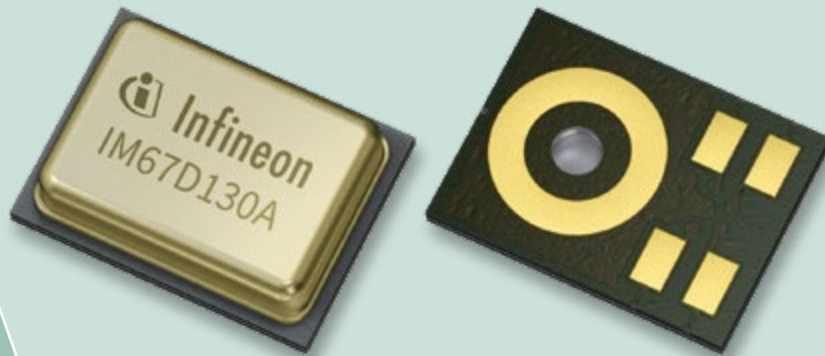

The highly sensitive XENSIV™ MEMS microphone IM67D130A allows the capture of distortion-free audio signals even in loud environments, and hence enables the use of sound as a complementary sensor for ADAS.

Quality leadership keeps customers loyal

Customers choose Infineon because we stand for the highest levels of quality, for reliability and for technological leadership. The satisfaction of our customers attests to the fact that this rigorous approach to quality is successful. By way of example, in the 2021 fiscal year, Infineon was again recognized by several leading manufacturers in the automotive and computer industry, who paid tribute in particular to very good collaboration during periods of chip shortages. We received the Best Collaboration Award from the Chinese subsidiary of automotive supplier Bosch as well as the Best Supplier Award from the Taiwan-based server manufacturer Quanta for brilliant services, strategic collaboration, and logistic fulfillment.

Strategic differentiation through in-house manufacturing

All our actions are designed to create, on the one hand, added value for the customer and, on the other hand, potential differentiation for us. This also applies to manufacturing. We manufacture in-house when doing so means we can differentiate ourselves from the competition through lower cost or higher performance. Typically, this is the case for power components and sensors. However, when it comes to standard technologies where the intellectual property lies above all in the design or in the software, we work primarily with contract manufacturers. This is predominantly the case for highly-integrated products, such as microcontrollers, connectivity components, security ICs and memory ICs. As a result of the current shortage of manufacturing capacity in the standard technologies – for Infineon this applies mainly to feature sizes of 65 nanometers and 40 nanometers – we have signed supply agreements with our contract manufacturers, which in some cases are multi-year agreements, to ensure better delivery capability.

Our outstanding manufacturing methods and our process and manufacturing expertise give us a strategic advantage in many application areas, such as power electronics and sensor technologies, enabling us to offer differentiating components.

With our 300-millimeter thin wafer manufacturing technology for power semiconductors, we have made a breakthrough. As pioneers of this technology, the scale of manufacturing we have now reached allows us to achieve significant economies

of scale. Compared with manufacturing on 200-millimeter wafers, we benefit here from lower costs, with equal productivity and a lower capital intensity. We have taken a further step to extend our lead. With the new factory at the Villach (Austria) site, together with our 300-millimeter manufacturing facility in Dresden (Germany), we

have established a closely coordinated manufacturing network across the two sites. In line with our “One Virtual Fab” concept, we are using the same processes, equipment, and automation and digitization concepts in Villach and in Dresden. This brings cost advantages, but it also benefits the customer, as we can rapidly shift production volumes between the sites. By expanding our manufacturing capacity, especially as a result of the start-up of our new 300-millimeter factory in Villach, we are sending a strong signal to our customers that Infineon is the ideal partner for future growth.



Key aspects of the focus of our manufacturing landscape include not only innovative strength and delivery capability, but also quality and productivity. Our manufacturing strategy (of applying leading manufacturing technologies and process expertise in our in-house manufacturing, while outsourcing in areas with little differentiation) ensures growth, competitiveness and flexibility.

Innovation drives differentiation

Innovation is one of the fundamental success factors in the semiconductor industry and is the basis on which we differentiate ourselves from the competition. Infineon has shown time and again that our technological and product innovation enables us to grow faster than the market. However, the challenges are becoming greater. In the attractive markets where we are active, competition is increasing, and we require an ever-broader technology portfolio to remain competitive in these markets in all applications. In addition, development costs are increasing disproportionately with

each further step, as the technologies approach successive physical limits. This fact underlines the importance of economies of scale and the relationship between technology leadership and size. Previous formulas for success fall short under these conditions and have to be either expanded or replaced.

This is why innovation and system thinking ideally complement one another. We consider what the key factors are and how we can combine several innovative steps, which may sometimes appear rather small, to form a greater whole that will in turn provide an additional and noticeable benefit to the customer. Our commitment to innovation today covers all areas of our company: logistics, operations, technology, products, system solutions and cooperation with our customers. We focus on different aspects, depending on market demands. Within the company, the focus is on innovation in our business activities and on continuous improvement, with the aim of becoming leaner and faster. The key to success is collaboration across organizational boundaries and the resultant creation of a working environment that helps us expand our innovative expertise. In parallel with a structured innovation process, we have successfully established new concepts that do not take a hierarchical approach but are based on the initiative of our employees and therefore provide the necessary freedom to act.

The digital transformation plays a crucial role here. As a global semiconductor manufacturer, we benefit from the digital transformation in two ways: on the one hand, as a provider and, on the other, as a user of digital solutions. As a provider, we use digitization to service our customers in the best possible way using efficient platforms. An important aspect here is the digitization of technical support, which we continuously drive forward. Technical support is essential to build and maintain customer relationships in fragmented markets. We enable customers to have direct access to the information they require in order to



solve potential problems efficiently, simply and independently. As a user, on the other hand, we also use digitization to optimize our internal processes and to make them as efficient as possible. So, for example, we connect our sites and organize our global supply chains in accordance with Industry 4.0 in a virtual manufacturing network. In sales and marketing, we are using new methods for analyzing big data to improve our cross-segment sales opportunities and, as a result, we can provide more targeted solutions for our customers' needs. With initiatives such as these, we are building our digital expertise and becoming even more competitive. We are taking an exploratory approach to make the best use of the potential of the digital transformation. This way, we gather experience based on specific use cases and work towards solutions in an iterative process.

IoT and big data are constantly bringing new players to the electronics marketplace, and they call for a strong partnership across a variety of competence areas. In this dynamic environment, joint innovation is the key to corporate success. One example is our Silicon Valley Innovation Center, a start-up center for innovations. It provides a platform on site for investigating new ideas and for fast learning. We also operate co-innovation spaces, the first of which we opened in Singapore. With our experience and expertise, we support the typical skill set of start-ups trying out new technologies and applications and bringing some of them to market. This way, both sides benefit. This approach also lets us accelerate our own innovation processes and penetrate further into new and adjacent markets. One example of this is our collaboration with a start-up that enables new utilization concepts in its product with gesture control and audio transmission through the finger bones: i.e., structure-borne sound. A large number of different Infineon components are used in this application.

Flexible marketing approaches enable Infineon to adapt to rapidly changing markets

To reach more customers, we will be even more flexible in the future, and we will develop new approaches. Historically, Infineon has grown through close collaboration with key customers. With these customers, we have successfully defined products that then enabled us to penetrate the wider market. We reach many of our smaller customers through distributors. We intend to take even greater advantage of the huge

potential of the distribution channel with standardized but configurable products for the wider market. We have made good progress here in recent years, because we have focused on continuous targeted adjustment of the product portfolio and close partnership with distributors.

Digitalization is providing a boost to potential applications. More and more devices can be upgraded to include new functions through connection to the internet. We acquired the components and expertise needed here through our acquisition of Cypress. Next, we want to provide our solutions to existing customers and, in particular, new customers who want to make their products smart and to help them upgrade their products quickly and without encountering obstacles. For most of these new customers, semiconductor technology is only a means to an end. They have neither the ability nor the desire to deal with it themselves. The challenge is to offer this very varied clientele the service they expect using the available resources as effectively as possible.



For these customers, we offer easy-to-use solutions using, for example, optimized product combinations, reference designs and basic software. Here, in particular, our system understanding makes a difference.

At the same time, we engage in networks consisting of distributors, development service providers and manufacturing service providers. These networks enable smaller companies and start-ups to come together to develop and manufacture electronics for new functions or new end devices. Applying this broad-based sales strategy, we want to maximize revenue from existing technologies, while at the same time increasing the return on our investment in research and development.

Sustainable growth: optimized manufacturing processes, efficient products and binding carbon emissions targets

To be successful in the long term, economic success must go hand in hand with environmental and social commitment. Our “making more from less” approach has shaped our actions for a long time. A key factor in arriving at greater sustainability and solving climate challenges is technologies that achieve more with fewer resources and save emissions at the same time. By fully adopting this approach, also in its manufacturing, Infineon consumes 17 percent less water and 44 percent less electricity and produces 67 percent less waste in its frontend factories than the global average of semiconductor companies represented on the World Semiconductor Council. We work constantly on avoiding direct emissions and on continuing to reduce the energy requirements of our facilities and processes.

Through good resource management, our products and solutions make an active contribution to climate protection. During their service life, they contribute to savings of around 72.45 million tons of carbon equivalents. We know, however, that we can do even more. We have been working for years on reducing our carbon emissions and have set ourselves binding carbon reduction targets. Thus we will become carbon-neutral by 2030; by 2025 emissions are to be reduced by 70 percent compared to 2019. This target relates to Infineon’s own footprint for greenhouse gases and includes not only direct emissions, but also indirect emissions from electricity and heat. Our primary focus here is on continuing to improve energy efficiency and on reducing carbon in our factories. We will achieve the greatest impact from PFC exhaust air abatement,



in which we have invested for years, and we will continue to increase this where it is beneficial and adapt it to different production conditions. In addition, we will gradually be switching our electricity supplies to renewable sources of energy. At our European sites we have already switched to 100 percent green electricity. At our sites, energy teams who are responsible for the implementation of efficiency measures also play a key role. The ongoing transition to state-of-the-art 300-millimeter process technology and the promotion of Industry 4.0 enable us to achieve further significant savings. We also expect the introduction of an in-house carbon prize to act as an incentive for efficiency improvement measures: Energy-efficient projects are becoming more economical. Moreover, we are promoting electromobility by expanding the charging infrastructure at our sites. We will offset the small remaining part of our emissions with certificates that combine development support and carbon avoidance.

Long-term financial targets underline our growth ambitions

In the coming years, structural trends will drive our growth, in particular, electromobility, automated driving, renewable energy, manufacturing automation, mobile phone standard 5G, data centers, IoT and a steadily increasing number of battery-powered devices. Thanks to our leading technologies, our understanding of applications and systems, and our differentiating expertise in manufacturing, we have achieved an outstanding position in these markets. We want to take advantage of the resulting opportunities and continue to grow at a faster rate than the markets in which we operate, gradually increasing our profitability. To do so, we consistently invest. Our long-term financial targets reflect this aspiration. They apply over the cycle and are based on a stable macroeconomic environment.

Target 1: Average annual revenue growth of more than 9 percent over the cycle

We hold leading positions in our core markets and have expanded systematically over the years into new and adjacent markets. Our four segments focus on the aforementioned trends. Our strategic approach “Product to System” has gained even greater impetus due to our integration of Cypress’ product portfolio. As a result, we use our extensive technological and product expertise to develop better solutions and thus create significant added value for our customers. We expect to achieve revenue growth in the future of more than 9 percent (“9%+”) over the cycle.

Target 2: 19 percent Segment Result Margin over the cycle

Growth is only one prerequisite for sustainable success. Another criterion is profitability. When we work profitably on a sustainable basis, it allows us even in weaker market phases, to consistently pursue our development projects. Therefore also our profitability target of achieving a Segment Result Margin of 19 percent applies over the cycle. Reaching this level will be based on a number of factors: Our system solutions create higher value. We thereby focus our development on designs that are of the greatest use to our customers and for which we will be accordingly rewarded. Our technology leadership and our strategic approach “Product to System” enable us to maintain a higher degree of differentiation. The integration of Cypress and the related revenue and cost synergies are also improving our profitability. Furthermore, we rely on the economies of scale and cost advantages generated by innovative manufacturing technologies such as 300-millimeter thin wafer manufacturing. In addition, we strive for a disproportionately low increase in functional costs such as selling, general and administrative expenses.

On the other hand, we are confronted with increased cost for contract manufacturers and materials. Moreover, initial development costs will be incurred, preceding the generation of revenue synergies and the commercialization of new technologies, in particular the materials SiC and GaN. These factors are considered in our target of achieving a Segment Result Margin of 19 percent over the cycle.



Target 3: Investments totaling 13 percent of revenue over the cycle

Our planning is geared towards providing the necessary manufacturing capacity for our expected growth. In the area of power semiconductors, one of the factors differentiating Infineon from the competition is that we manufacture our own products. To generate growth in this field, we are planning to expand our 300-millimeter production as well as expanding capacity for SiC and GaN. In the area of microcontrollers, connectivity components and security ICs we will continue in the future to work together primarily with our manufacturing partners. We are therefore able to set our investment rate target at 13 percent of revenue over the cycle. When calculating the investment rate, we do not include step-cost investments in clean rooms or major office buildings.

Capital structure targets demonstrate our long-term reliability

The sustainable continuation of the company is of great importance from a variety of perspectives. It is important to our customers that we remain a trusted partner and reliable supplier for many years to come. Our debt providers need to be certain that we can repay principal and pay interest over a long period of time, while our shareholders want to achieve an attractive return over the mid to long term. Long-term reliability is something we also want to offer our employees, even well beyond their working lives through retirement benefits. We therefore attach great importance to solid creditworthiness. An investment grade rating is and remains the key element of Infineon's conservative financial policy. From this cornerstone, we derive our medium-term and long-term capital structure targets. On 11 February 2021, S&P confirmed Infineon's investment grade rating of BBB- and raised its outlook to positive.

Infineon's capital structure targets consist of a liquidity target and a leverage target. For liquidity, our gross cash should amount to €1 billion plus at least 10 percent of revenue. The fixed base amount of €1 billion provides a solid liquidity reserve for contingent liabilities and pension liabilities, which are unrelated to revenue. The additional amount of at least 10 percent of revenue means that we always have access to sufficient cash to be able to finance our operating business and investment throughout all the phases of the semiconductor cycle.

Our leverage target is expressed as an upper limit on gross financial debt of two times EBITDA. Infineon defines EBITDA as earnings (loss) from continuing operations before interest, taxes and depreciation and amortization. As a result of the acquisition of Cypress, we exceeded this level, but only to the extent compatible with retaining our investment grade rating. The originally medium-term objective of Infineon to reduce its debt level to or below the maximum target value after the closing of the Cypress transaction is expected to be achieved already in the 2022 fiscal year.

We took further steps in the refinancing process in the 2021 fiscal year, focusing on the term loans that were deliberately raised in US dollars as part of the acquisition financing. In April 2021, Infineon signed a private placement of bonds in the United States with a volume of US\$1.3 billion in four tranches with maturities of six, eight, ten and twelve years. As a result, the term loan due in 2022 was fully repaid, as were US\$745 million of the term loan due in 2023. The transaction was completed in June 2021. Following a further partial redemption of US\$365 million in September 2021, only one US\$1,110 million term loan due in 2024 remained outstanding at the end of the 2021 fiscal year.

Human Resources strategy

We view our Human Resources (HR) strategy from a position of overarching responsibility. Firstly, it makes a decisive contribution to ensuring Infineon's ability to achieve its growth and profitability targets and successfully navigate through varying economic phases and challenges. Secondly, we also feel to have the responsibility to contribute to solving the major challenges currently facing society. Our HR understanding "People create value. HR fosters people engagement" remains unchanged. It was rolled out globally in 2020 and is now firmly embedded throughout the Infineon organization. Our overriding objective is to foster our employees' engagement and to take the necessary measures to achieve this. When employees are enthusiastic about their job,

possess the required skillsets and are given opportunities for further development, they not only display higher levels of creativity, productivity and innovation, but also create better outcomes, which goes hand in hand with a personal sense of achievement and greater motivation. Regularly conducted pulse checks of our employees worldwide enable us to measure their level of engagement and thus keep our finger on the pulse of their needs. Appropriate measures are taken as the need arises.

The coronavirus pandemic continued to necessitate swift, carefully considered action in the field of HR in the fiscal year just ended. The health of our employees is our foremost priority. At the same time, however, we also need to ensure business continuity. With a variety of testing and vaccination concepts at its sites, Infineon undertook a raft of measures designed to optimally support and safeguard not only its employees, but the business as a whole.

The future of work is impacted by megatrends such as digitalization, artificial intelligence, the collaboration of man and machine and the (de)globalization of markets. Most recently, the coronavirus pandemic acted as a "time machine to the future". Changes related to "New Work" that were predicted to take place over the next few decades happened within just a few months. In recent years, Infineon has introduced a number of digital tools and processes that have helped to keep our business running successfully, even after the outbreak of the coronavirus pandemic. Our task now is to make further use of the foundations already in place and build on them to define a comprehensive understanding of "New Work" for Infineon.

In order to remain innovative, competitive and successful going forward, Infineon is in constant search of the most highly talented individuals. This is a challenge in itself, as talented people in the STEM fields (science, technology, engineering and mathematics) remain in great demand on the labor market. In the fiscal year just ended, Infineon recorded its highest level of new hires in recent years. One of Infineon's great advantages is its positive brand and employer image, which helps us in our efforts to recruit and retain talents. The fact that we manufacture future-oriented products that create value for society makes our company a highly attractive prospect to many potential employees.



To strengthen a positive employee experience and the resulting high level of engagement, it is also important to continuously develop employees and managers. We have geared our learning methods towards digitalization and offer the right formats for the relevant content. We provide our employees with a wide range of high-quality training courses in various languages, many of which are virtual and can therefore be accessed from anywhere and at any time. Due to the dynamic market environment, our leaders are regularly faced with new challenges and therefore the approach to leadership development at Infineon was revised during the fiscal year just ended. For example, various new and integrated offerings were introduced to foster and strengthen the self-reflection of our leaders. Moreover, new leadership programs have been developed and made available, with the aim of encouraging leadership development in line with specific leadership requirements. Where appropriate, we draw on the expertise of external partners. For example, we have entered into a strategic partnership with INSEAD Business School to handle selected aspects of our management training program.

In addition to all the above-mentioned topics, the successful integration of Cypress remains a high priority. HR is playing a significant role in integrating more than 6,000 former Cypress employees worldwide – from a strategic, financial and cultural point of view. During the fiscal year just ended, we were able to integrate these new colleagues in our organization, processes, systems and remuneration logic and at the same time initiate the necessary onboarding and training measures at both individual and team level. These are important steps in our ongoing efforts to successfully integrate our new colleagues who have joined Infineon as a result of the acquisition of Cypress.

We also define ourselves through a motivating working environment and in the way we collaborate with each other, embracing a distinctive feedback culture, actively practiced leadership principles and worldwide interaction with colleagues from over 100 nations. We are proud of this diversity and will continue to cultivate it with the aim of taking in additional dimensions of diversity and inclusion going forward.

We see diversity as the natural participation of everyone concerned and a key factor for our enduring success. The perception that skills and behavior complement each other is an essential part of our recruitment and organizational development strategy. Our objective for the dimension “gender” is to achieve a share of 20 percent of women in leadership positions by 2030, an aim also reflected in our Environmental, Social and Governance (ESG) targets, which are part of Infineon’s Long-Term Incentives (LTI). We will continue to focus on this factor with the aim of constant progress in mind.

Customer centricity, ease of use, efficiency and a proactive approach to development are key points of focus in our ongoing HR services and support work. Moreover, the expectations of the younger generation differ significantly from those of the past and present us with new challenges. The digital transformation of HR at Infineon has enabled us to take a decisive step towards meeting these expectations. In doing so, we are focusing on business requirements and at the same time continuously developing our HR capabilities. In the course of the 2021 fiscal year, we developed a new concept for Human Resources Shared Services going forward and intend to roll it out globally in the upcoming fiscal year. The focus is on creating a positive customer experience for employees and managers as well as the further standardization and digitalization of “end-to-end” processes and services. We also launched the Career Project during the 2021 fiscal year with the aim of creating an inspiring career environment that promotes individual development while contributing to business value, both now and in the future.

People are the main focus of our activities, as dedicated, healthy, successful employees are key to maintaining and improving our market-leading position, thereby creating a successful future for us all.

Further information, including detailed statistics, is available in the 2021 Sustainability Report and the 2021 Human Resources Report.

www.infineon.com/csr_reporting www.infineon.com/hrreport

Combined Management Report

50 Business model**52 Review of the semiconductor industry****55 2021 fiscal year****58 The segments**

60 Automotive

65 Industrial Power Control

70 Power & Sensor Systems

75 Connected Secure Systems

80 Research and development

87 R&D sites

88 Manufacturing

91 Manufacturing sites

92 Internal management system**95 Sustainability at Infineon****96 The Infineon share****99 Group performance**

99 Review of results of operations

103 Review of financial condition

105 Review of liquidity

109 Report on outlook, risk and opportunity

109 Outlook

112 Risk and opportunity report

124 Overall statement on Infineon's financial condition**125 Infineon Technologies AG****128 Corporate Governance**

128 Information pursuant to section 289a, paragraph 1, and section 315a, paragraph 1, of the German Commercial Code (HGB)

132 Statement on Corporate Governance pursuant to section 289f, 315d of the German Commercial Code (HGB)/Corporate Governance Report

132 Remuneration report

151 List of references

This report combines the Group Management Report of Infineon ("Infineon" or "Group") – comprising Infineon Technologies AG (hereafter also referred to as "the Company") and its consolidated subsidiaries – and the Management Report of Infineon Technologies AG.

The Combined Management Report contains forward-looking statements about the business, financial condition and earnings performance of Infineon. These statements are based on assumptions and projections based on currently available information and present estimates. They are subject to a multitude of uncertainties and risks. Actual business development may therefore differ materially from what has been expected. Beyond disclosure requirements stipulated by law, Infineon does not undertake any obligation to update forward-looking statements.

The business with the XMC™ family of industrial microcontrollers was transferred from the Automotive segment to the Connected Secure Systems segment with effect from 1 October 2020. The previous year's figures have been adjusted accordingly.

The content of these sections is voluntary content that has not been checked by the auditor but only read critically. In the case of cross-references, the information to which the cross-references refer was not checked either.

Business model



With 50,288 employees worldwide, Infineon is a leading global provider of semiconductors. Semiconductors connect the real world and the digital world. They enable, for example, intelligent mobility, efficient energy management and the secure collection and transmission of data. Infineon designs, develops, manufactures and markets a large number of semiconductor and system solutions, focusing on the automotive, industrial, and information and communications markets, as well as on hardware-based security. Its products range from standard components to customer-specific solutions for components and systems, all the way to special components for digital, analog and mixed-signal applications.

Infineon is divided into four segments, each of which derive their long-term focus from the Group strategy. All the Group's activities relate to one of the higher-level growth drivers – energy efficiency, mobility, security, and IoT and big data. [See the chapter “Growth drivers”, □ p. 22 ff.] The segments are each responsible for particular areas that reflect their core competencies (see the chapter “The segments”, □ p. 58 ff.).

Infineon covers the main stages of the semiconductor value chain: from the design, via frontend and backend manufacturing, to delivery to customers, [C09](#). It operates 56 research and development sites worldwide to develop chips, software, and manufacturing technologies (see the list of sites on the page “R&D sites”, [p. 87](#)).

Our manufacturing landscape covers both stages of semiconductor manufacturing: frontend and backend. In frontend manufacturing, the wafers are processed. Optical, physical and chemical methods are used to implement transistors and their interconnections, thus determining the function of the chip. The wafers are dispatched from the frontend site to a backend site, where the remaining processing steps take place in backend manufacturing. These steps include sawing the wafer into individual chips as well as assembly and testing. Finally, the chips are dispatched to the distribution centers. At the end of the 2021 fiscal year, Infineon operated 20 manufacturing sites (see the list of sites on the page “Manufacturing sites”, [p. 91](#)).



C09 The main stages of the semiconductor value chain

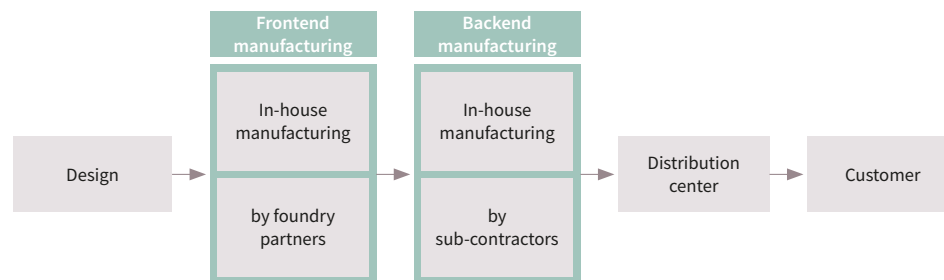

In frontend manufacturing, in order to optimize the use of capital and increase flexibility, we use external manufacturing partners, called foundries, in addition to our in-house manufacturing. This applies primarily to technology nodes of 65 nanometers or smaller and to older generations of power semiconductors. In backend manufacturing, particularly in assembly and testing, we also use manufacturing partners, called subcontractors, for standardized package types. More information about our manufacturing strategy is given in the chapter “Manufacturing”, [p. 89](#).

Following the completion of backend manufacturing, the products are dispatched and sent to customers via regional distribution centers.

Review of the semiconductor industry



Review of the semiconductor market in the 2021 fiscal year (in euros)

Global semiconductor revenue in the 2021 fiscal year was €436.887 billion,  R08. This is an increase of 13.7 percent compared with the figure for the same period of the previous year of €384.109 billion.

Growth in the 2021 fiscal year was mainly due to the digitalization push during the coronavirus pandemic and to the resulting strong demand throughout the year for data centers, smartphones, consumer electronics, PCs, notebooks and PC accessories. However, some industrial projects (including in particular the expansion of high-speed trains in China) were postponed or curtailed as a result of the coronavirus pandemic.

There were also several months of interruptions in automobile production. In addition, for various reasons, there were Manufacturing stoppages in the semiconductor industry itself, which resulted in a chip shortage in some product categories.

The global market for semiconductors without microprocessors, DRAM and NAND flash memory grew by 16.7 percent, from €236.673 billion in the 2020 fiscal year to €276.293 billion in the 2021 fiscal year,  R08. In the same period, Infineon's revenue increased by 29.1 percent. Cypress has been fully consolidated since 16 April 2020. This limits the comparability of the current figures with those of the prior year.

Review of the semiconductor market in the 2020 fiscal year (in US dollars)

In the 2020 calendar year, global semiconductor revenue was US\$473.713 billion. This was the second highest figure ever for annual revenue. The highest figure, of US\$485.313 billion, was achieved in the 2018 calendar year. Compared with the revenue generated in the 2019 calendar year of US\$428.832 billion, growth in revenue in the 2020 calendar year was 10.5 percent. 

As in 2019, there were only three companies in 2020 with a market share of more than 5 percent: Intel (16.1 percent), Samsung (12.0 percent) and SK Hynix (5.6 percent),  **C10**. For Infineon, the revenue figure calculated by Omdia for the 2020 calendar year was US\$11.215 billion. This represents a market share of 2.4 percent and 9th place in the ranking of companies according to revenue. Revenue from Cypress was included for both the full 2019 calendar year and the full 2020 calendar year. Infineon's revenue grew at a slower pace than that of the semiconductor market as a whole due to the high proportion of its revenue derived from automotive and industrial applications.

Nvidia was able to increase its revenue by 37.3 percent – or around US\$3.5 billion – to US\$13.035 billion and thus oust Infineon from the 8th place it held in 2019. Of the 20 largest semiconductor companies, the following are direct competitors of Infineon in at least one product category: Samsung, Qualcomm, Texas Instruments, STMicroelectronics, NXP, Renesas and Analog Devices.

In December 2020, Taiwanese wafer manufacturer GlobalWafers announced its acquisition of German wafer manufacturer Siltronic for around €4.4 billion. In February 2021, GlobalWafers secured more than 50 percent of the shares of Siltronic, thus reaching the minimum acceptance threshold. The transaction is expected to be completed in the first half of the 2022 calendar year. Infineon purchases wafers from both companies.

In February 2021, Japanese semiconductor manufacturer Renesas announced its acquisition of Dialog Semiconductor for around €4.9 billion. The transaction was completed on 31 August 2021. Infineon is a competitor of both companies in some product categories.

C10 Top 20 semiconductor manufacturers in the 2020 calendar year

Revenue in billion US\$

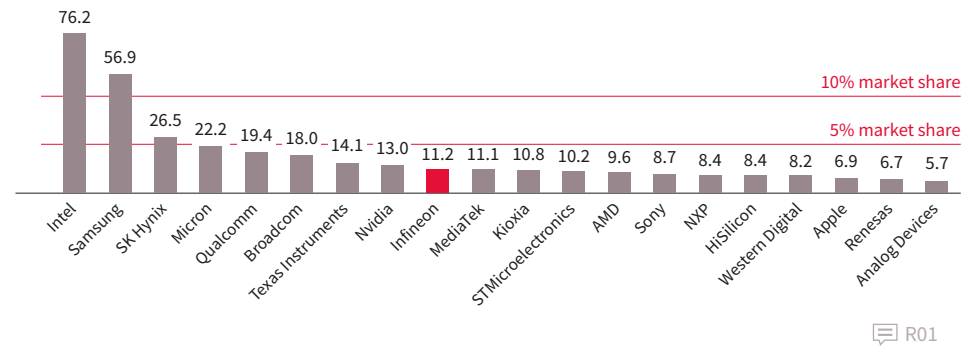

Frontend contract manufacturers are not included in this market research.

In August 2021, US semiconductor manufacturer onsemi announced its acquisition of SiC materials manufacturer GT Advanced Technologies for US\$415 million. The transaction is expected to be completed in the first half of the 2022 calendar year. Infineon is a competitor of onsemi in some product categories and purchases SiC materials from GT Advanced Technologies.

In August 2021, US semiconductor manufacturer Synaptics announced its acquisition of Israel-based company DSP Group for around US\$538 million. DSP Group develops digital signal processors and chipsets for wireless communications and audio applications. Infineon is a competitor of Synaptics in some product categories.

The acquisition of Maxim by Analog Devices announced in July 2020 was completed in August 2021. The transaction was valued at US\$28 billion. Infineon is a competitor of both companies in only a few product categories.

The 20 largest semiconductor companies accounted for 74.4 percent of global semiconductor revenue in the 2020 calendar year (2019: 73.0 percent). The remaining 25.6 percent (2019: 27.0 percent) was spread over more than 1,500 other semiconductor companies. The semiconductor industry is therefore highly fragmented. The consolidation process has advanced at different rates depending on the product category. [R01](#)

Greater China has played the dominant role for years in terms of regional semiconductor revenue. In the 2020 calendar year, Greater China increased its share of the global semiconductor market still further to 58 percent, compared with 56 percent in 2019, [R09](#). In Greater China, and especially in Mainland China, contract manufacturers known as EMS (Electronic Manufacturing Services) play a special role. These companies assemble electronic products predominantly for Western customers. This business model applies particularly to consumer durables and to IT and telecommunications products such as servers, PCs, laptops, tablets and mobile phones. Most of the semiconductors delivered to and mounted in Mainland China are re-exported as part of a finished product. [C11](#)

In terms of purchasing volume, the top 20 semiconductor consumers accounted for US\$214.353 billion, equivalent to a share of 65.3 percent (2019: US\$184.497 billion with a share of 62.1 percent). [C12](#)

The boom in demand for data centers, smartphones, consumer electronics, PCs, notebooks and PC accessories is clearly shown by almost all the semiconductor consumers increasing their purchasing volume. Out of the top 20 companies, only the two automotive suppliers, Bosch (in 12th position) and Continental (in 15th position), reduced their purchasing volume. Denso, another automotive supplier with a purchasing volume that shrank, which was in 17th position in 2019, was no longer one of the top 20 semiconductor consumers in the 2020 calendar year. At US\$42.821 billion, the purchasing volume of Apple is now significantly higher than the total purchasing volume of the global automotive industry. [R10](#)

C11 Global semiconductor sales in the 2020 calendar year by region (total market size US\$473 billion)

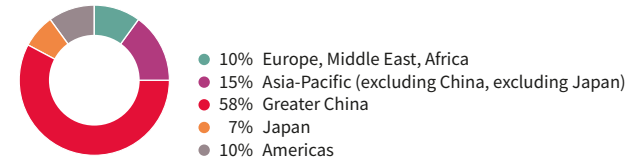

[R09](#)

Greater China comprises Mainland China, Hong Kong, Macau, and Taiwan.

C12 Top 20 semiconductor consumer in the 2020 calendar year

Purchasing volume in billion US\$

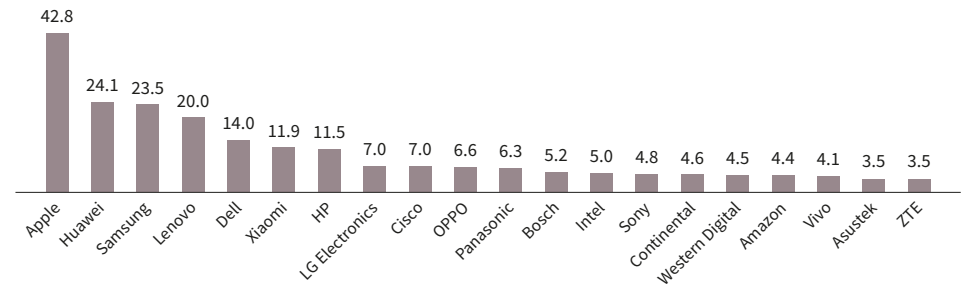

[R10](#)

2021 fiscal year

- › Infineon records revenue of over €11 billion for first time
- › Profitability significantly up: Segment Result Margin rises to 18.7 percent (2020: 13.7 percent)
- › Dividend set to be raised to 27 cents per share

Revenue up by 29 percent; Segment Result Margin rises to 18.7 percent

Infineon achieved a revenue of €11,060 million in the 2021 fiscal year, 29 percent up on the previous year's figure of €8,567 million and in line with the adjusted forecast of around €11 billion. Firstly, revenue went up on the back of continued high demand for semiconductors and the related expansion of manufacturing capacities, with the resulting positive volume and pricing effects causing revenue to grow. Secondly, the higher revenue was driven by the acquisition of Cypress in April 2020. For the first time, Cypress contributed to Group revenue for a full fiscal year, whereas in the fiscal year just ended Cypress' revenue was only included for the period from April to

September. Pandemic-related constraints, for example on manufacturing capacity in Melaka (Malaysia) and on contract manufacturers, and the aftermath of the winter storm in Austin (Texas, USA) held down revenue growth.

The segments all developed positively, with Automotive remaining the largest in revenue terms. Based on segment revenue of €4,841 million (2020: €3,521 million), Automotive contributed 44 percent of Infineon’s total revenue, up by 37 percent on the previous year. The Power & Sensor Systems segment recorded revenue of €3,268 million (2020: €2,650 million), corresponding to a growth rate of 23 percent. Both segments included revenue contributions from Cypress. Revenue generated by the Industrial Power Control segment totaled €1,542 million and was therefore 10 percent above the previous year’s figure (2020: €1,406 million). The Connected Secure Systems segment reported revenue of €1,397 million (2020: €974 million), up by a significant 43 percent and largely driven by an improved product mix and the acquisition of Cypress.

The development of the US dollar exchange rate to the euro, which averaged 1.19 for the year compared to 1.12 one year earlier, had a negative impact on revenue.

C13 Revenue by segment in the 2021 fiscal year

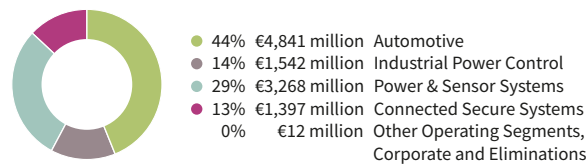

The **Segment Result** totaled €2,072 million for the 2021 fiscal year, 77 percent up on the €1,170 million reported one year earlier. One of the factors contributing to this strong earnings performance was the decline in idle costs compared to one year earlier. It was also possible to pass on increased procurement prices to customers. By contrast, the pandemic-related restrictions on manufacturing in Melaka and the shutdown of the fabrication plant in Austin had a negative impact on the Segment Result.

The **Segment Result Margin** of 18.7 percent was accordingly higher than the previous fiscal year’s figure of 13.7 percent, and hence in line with the most recent forecast of more than 18 percent, as upwardly adjusted in the third quarter.

Key performance indicators for Group up on previous year

Profit for the period improved to €1,169 million (see the chapter “Review of results of operations”, [p. 102](#)), representing an increase of €801 million compared to the previous fiscal year’s figure of €368 million. The resulting **earnings per share** for the 2021 fiscal year amounted to €0.87 (basic and diluted) and were thus significantly above the preceding year’s figure of €0.26 (basic and diluted). **Adjusted earnings per share (diluted)** for the year under report amounted to €1.20 (2020: €0.64).

The **Return on Capital Employed (RoCE)** rose from 3.0 percent to 8.4 percent year over year, mainly reflecting the sharp rise in **operating profit from continuing operations after tax** from €473 million to €1,325 million (see the chapter “Review of results of operations”, [p. 99 ff.](#)). **Capital employed** stood at €15,793 million as of 30 September 2021, very similar to the amount reported one year earlier (30 September 2020: €15,827 million).

Free Cash Flow from continuing operations was a positive amount of €1,574 million in the 2021 fiscal year (2020: negative €6,727 million) and arose mainly due to the high level of net cash provided by operating activities from continuing operations totaling €3,063 million (2020: €1,817 million). The figure reported for the previous fiscal year was influenced primarily by the net payment (i.e., net of cash and cash equivalents acquired) amounting to €7,433 million used to acquire Cypress.

The **gross cash position** improved by €695 million to stand at €3,922 million at the end of the reporting period (30 September 2020: €3,227 million), with the increase resulting mainly from high Free Cash Flow amounting to €1,574 million.

The **net cash position** at the end of the 2021 fiscal year was a negative amount of €2,663 million (30 September 2020: negative €3,806 million).

Dividend payment of €0.27 per share planned

Our dividend policy is aimed at letting shareholders adequately participate in Infineon's economic development and, in general, at paying out at least an unchanged dividend even in the event of stagnating or declining earnings. However, due to the negative economic impact of the coronavirus pandemic, the risks that existed at the time of the payout, and in order to maintain sufficient financial flexibility, a dividend of €0.22 was paid for the 2020 fiscal year, i.e. €0.05 lower than the amount distributed for the

2019 fiscal year. Due to Infineon's good economic performance in the 2022 fiscal year and the positive outlook for the current fiscal year, the dividend is now to be increased again by €0.05. Accordingly, a proposal is planned to be put forward at the Annual General Meeting in February 2022 to distribute a dividend of €0.27 per share for the 2021 fiscal year. The number of shares issued totaled 1,305,921,137 as of 30 September 2021. The figure includes 4,545,602 shares owned by the Company that are not entitled to a dividend. The total dividend amount would therefore increase to €351 million, compared with €286 million one year earlier.

C14 Dividend per share for the 2010 to 2021 fiscal years
in € cents

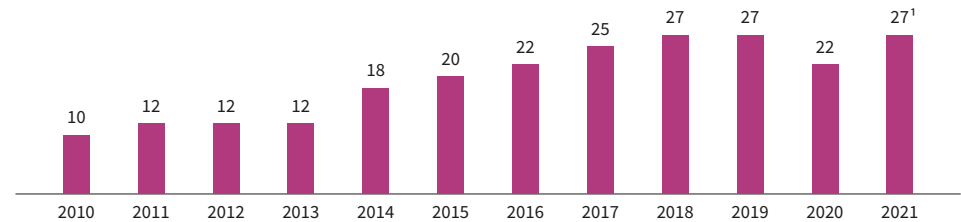

¹ Proposal to the Annual General Meeting to be held on 17 February 2022.

The segments



Infineon comprises four segments, each of which derive their long-term focus from the Group strategy. All the Group's activities relate to one of four key growth areas – energy efficiency, mobility, security, and IoT and big data. The segments are each responsible for particular areas that reflect their core competencies. The Automotive segment is responsible for the semiconductor business for automotive electronics, including activities with memory products. The Industrial Power Control segment concentrates on power semiconductors primarily used in industrial applications and renewable energy, while the Power & Sensor Systems segment addresses more

consumer-oriented applications and power supplies in general. Also falling within the sphere of responsibility of the Power & Sensor Systems segment are activities in the area of radio frequency and sensor-based applications, including the collection of sensor data and interaction with machines and devices. Microcontrollers for non-automotive electronic applications, connectivity solutions and activities relating to traditional and new security applications are bundled in the Connected Secure Systems segment.

In the areas of sensor technologies, power semiconductors, hardware-based security, radio frequency and embedded control, Infineon has continually developed and deepened its knowledge of its traditional core competencies. In particular, we have expanded our expertise in the area of sensor technologies to include the collection of other physical measurands, [III C15](#). As a result of the acquisition of Cypress, we greatly strengthened our position in the area of embedded control. Contributing to this are the extensive portfolio of microcontrollers and different types of memory for specific applications. Furthermore, with connectivity we acquired a new competence, indispensable for the IoT growth market. Combining this in turn with our security knowhow takes us to a new level.

Our markets are converging more and more, so that a strict organizational separation is not appropriate. Technologies and products are increasingly being used across the segments in line with our strategic approach “Product to System”. Digital transformation in particular requires flexible and innovative approaches. Teams from various organizational units work together on an application-oriented and expertise-specific basis. In such cases, one segment takes responsibility for the overall system and develops the roadmap for the application, while responsibility for the technologies and products required remains in the established organizational units of the other segments. Similarly, the segments collaborate on technology development. High-voltage power semiconductors for electromobility are, for example, a core topic in the area of automotive electronics, so it follows that the Automotive segment assumes responsibility here. On the other hand, it is the Industrial Power Control segment that takes on responsibility for fundamental developments in IGBT technology, IGBT module housing technology and SiC technology.

C15 Core competencies in the segments

Core competencies	Automotive	Industrial Power Control	Power & Sensor Systems	Connected Secure Systems
Sensor technologies	✓		✓	
Radio frequency	✓		✓	
Embedded control	✓			✓
Control of power semiconductors	✓	✓	✓	✓
Power semiconductors	✓	✓	✓	
Memories for specific applications	✓			
Connectivity				✓
Security	✓			✓
Software	✓			✓
Differentiating in-house manufacturing	✓	✓	✓	



REVENUE
€4,841 m



SEGMENT
RESULT
€792 m

Automotive

The Automotive segment shapes the future of mobility with products and solutions to make cars clean, safe and smart. We cover all application areas in the vehicle: powertrain and energy management, connectivity and infotainment, body and comfort electronics, safety and security. Our range of products and solutions helps to navigate the transition from internal combustion engines to hybrid or electric drives, as well as enabling an ever-increasing degree of automated driving, electric-electronic (E/E) vehicle architecture and greater connectivity, digitization and a higher level of data security in vehicles. We also offer our customers innovative solutions in the areas of safety, the digital cockpit, infotainment, comfort and lighting technology. In addition to sensors, microcontrollers, a reliable power supply, high-performance memory ICs for specific applications and power semiconductors based on Si and SiC, our product portfolio also comprises components for human-machine interaction and vehicle connectivity. Infineon is the world market leader in semiconductor solutions for cars. R02

Applications p. 240

Strategic focus

The automotive industry continues to experience a period of profound upheaval. The car of the future will be a purely electric vehicle, assisted, fully connected and always online. Even if this will not yet apply to every newly produced car by the end of the current decade, we are still seeing an acceleration in structural change compared with previous decades. The reasons for this are the desire for vehicles which are ever-safer, ever-smarter and increasingly connected and the need for compliance with ever-stricter emission standards and therefore for sustainable mobility. This is evident from automotive megatrends: electromobility, automated driving, connectivity and security. The greatest contribution to this process will come from vehicle electronics and consequently from semiconductor solutions. We are contributing to the change and want to benefit disproportionately from these trends. We have a broad product portfolio of automotive semiconductor solutions. With this portfolio and a high level of system expertise, Infineon can handle a wide range of automotive applications. These include powertrain, assistance systems, safety, comfort electronics, digital instrument clusters, infotainment applications and security.



Infineon supports the trend towards increasing connectivity. This includes both the communication between the various control units within the vehicle (for example, via CAN, CAN FD and FlexRay™) and the communication with other vehicles (vehicle-to-vehicle) and with the cloud (vehicle-to-infrastructure). It also includes the connection of mobile devices via Wi-Fi and Bluetooth for in-cabin infotainment. In the area of human-machine interaction, switches, buttons and dials will increasingly be replaced by touch pads. Human-machine interaction also includes head-up displays.

In the traditional applications, our growth will be driven by new functions in the areas of connectivity, lighting technology, comfort and safety, on the one hand, and by continuing electrification of various vehicle functions, on the other. This means that the number of electronic components per vehicle and therefore the value of the semiconductor content per vehicle will increase. The two megatrends electromobility and automated driving have the effect of further increasing the average semiconductor demand per vehicle. Even if it will take some time for autonomous driving to be introduced and to become widespread, driver assistance systems are in high demand and the strong growth they have already shown looks set to continue in the coming years. Driver assistance systems not only ensure greater driving comfort, but also contribute to the implementation of “Vision Zero”, the global project that seeks one day to achieve its aim of road traffic without fatalities.

We are benefiting from the trend towards automated driving, on the one hand, with our 77 gigahertz radar sensor ICs, which are used in emergency braking systems and increasingly in lane change assistance systems. On the other hand, we also provide dedicated microcontrollers which undertake a significant part of the radar signal processing. Our optimized radar system solutions (including radar sensor ICs, microcontrollers, power supply and



memory IC solutions) enable our customers to achieve faster time to market. Our microcontrollers are not only used in driver assistance systems that are radar-based, but also in those that are camera-based, as well as in sensor fusion systems up to Level 2+. The intermediate level 2+, which was retrospectively defined, includes those functions which are part of Level 3 except for the function of the complex handover of vehicle control between the vehicle and the driver.

For electromobility, Infineon has an extensive range of power semiconductors and control ICs with the corresponding packaging and connection technologies. Infineon also offers battery management solutions for the efficient charging and monitoring of battery systems. Infineon's semiconductor solutions are suitable for all types of electric vehicles: pure electric vehicles, plug-in hybrid vehicles and mild hybrid vehicles with 48-volt technology. Our portfolio also covers semiconductor solutions for vehicles based on emerging hydrogen technology. The AURIX™ family of microcontrollers is used both in the control of electric motors and in battery management.



In the area of power electronics, we are the undisputed market leader for Si-based power semiconductor solutions in the automotive market. In the fast-growing market for SiC-based components (diodes, discrete MOSFETs and power modules), we offer our customers alternative scalable solutions for greater efficiency and more compact design in the areas of drive trains and onboard chargers. In the medium term, we are also expanding our portfolio to include components based on GaN. Both compound materials, SiC and GaN, offer additional potential for improvements in efficiency and power density.

Our product portfolio meets the high quality and reliability requirements of the automotive industry. In the case of automated driving, the greater the trust in the technological innovations that are replacing the driver of the vehicle, the greater the acceptance and the sooner it will be possible to achieve higher levels of automation in vehicles – in private vehicles, taxis and buses, in utility and construction vehicles, in agricultural machinery and in public transport such as trains and trams. The prerequisite for gaining that trust is the reliability of the vehicles and thus the

reliability of the systems, components and semiconductor solutions built into them. They must all be fault-tolerant, must not fail and must ensure a minimum function if there are unexpected disruptions, and all this must apply for the service life of the vehicle. For some time now, Infineon has provided concepts and solutions for reliability at the component and subsystem level, adopting an integrated approach. Our semiconductor solutions – sensors, microcontrollers, memory, power electronics, power management ICs and security ICs – enable systems to meet the high functional safety requirements set out in ISO 26262. The AURIX™ family of microcontrollers is used, for example, in steering and braking, and as host controllers that contribute towards the functional safety of central control units. Other semiconductor solutions ensure both internal and external data communication.



Market position

In the 2020 calendar year, the automotive industry experienced its greatest decline in a decade as a result of the coronavirus pandemic. As most car manufacturers halted production for several months across all regions, demand for automotive semiconductors shrank by 6.0 percent from US\$37.186 billion in 2019 to US\$34.960 billion in the 2020 calendar year,  R02. An even greater decline was averted by the recovery in China in the second half of the 2020 calendar year and by surprisingly high demand for electric vehicles,  C16. The unexpected rapid resurgence in demand for cars and the boom triggered by incentive schemes for electric vehicles, on the one hand, and insufficient manufacturing capacity on the other resulted in the ongoing chip shortage.

Power semiconductors and controllers are the two largest product categories. Together they account for around half of all semiconductors in the automotive sector. Infineon was the market leader in the 2020 calendar year for power semiconductors, with a market share of 30.2 percent. In the case of controllers, Infineon had a market share of 16.9 percent and was in 3rd position. The gap between it and the two frontrunners Renesas (with a market share of 26.7 percent) and NXP (with a market share of 26.3 percent) narrowed, while the gap between Infineon and Texas Instruments (with a market share of 9.8 percent) widened. In the case of sensors, Infineon (with a market share of 15.5 percent) remained the second largest manufacturer behind Bosch (with a market share of 22.2 percent),  R02.

In the 2020 calendar year, Infineon remained the world's largest manufacturer of automotive semiconductors, with a 13.2 percent share of the total market,  C17. It slightly increased its lead over second-placed manufacturer NXP. The five largest market players together accounted for 48.4 percent of the market (2019: 49.2 percent).

In both regions with the greatest decline in market size, North America (9.5 percent) and Japan (9.4 percent), Infineon was able to significantly outperform the market, gaining market share, and in each case moving up one position. This means that Infineon is now at least in 2nd position in all regions,  C18. The trend in Japan, where the company has quadrupled its market share over the last ten years, is particularly encouraging.

C16 World market for automotive semiconductors in the 2020 calendar year
US\$34.960 billion (minus 6.0% compared with 2019)

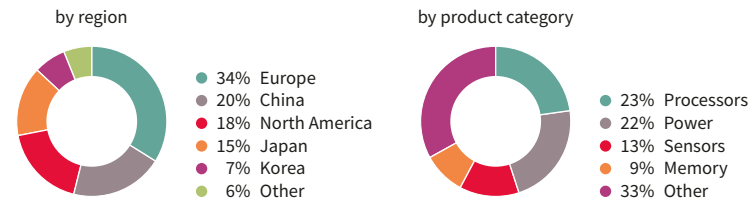

 R02

C17 Market share for automotive semiconductors in the 2020 calendar year



 R02

Comparability limited due to differing reporting period (fiscal year-end) and currency.

C18 Market share of Infineon for automotive semiconductors by region in the 2020 calendar year

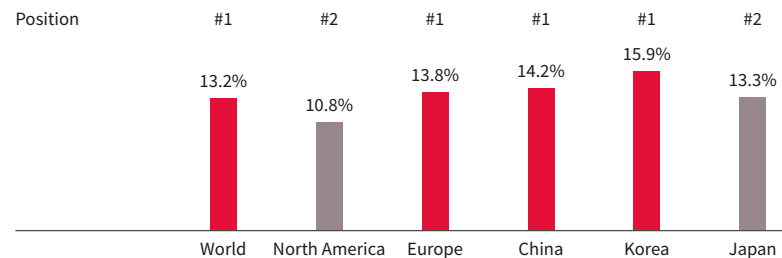

 R02

Review of the Automotive segment in the 2021 fiscal year

In the Automotive segment, Infineon generated revenue in the 2021 fiscal year of €4,841 million, an increase of 37.5 percent compared with the figure for the previous fiscal year of €3,521 million. Cypress was fully consolidated with effect from 16 April 2020, and therefore the comparability of the current-year figures with the prior-year figures is limited. The segment contributed 44 percent of Infineon's Group revenue.

In the 2021 fiscal year, the Segment Result was €792 million, an increase of 438.8 percent compared with the Segment Result for the previous fiscal year of €147 million. Based on revenue, the Segment Result Margin was 16.4 percent (previous year: 4.2 percent). [■ C19](#)

The increase in the Segment Result Margin was due to a higher revenue, a significant reduction in under-utilization costs and a 12-month contribution to revenue made by Cypress' business activities. Factors which had a negative impact on the Segment Result were restrictions on our manufacturing capacity as a result of the pandemic, especially in Melaka (Malaysia), and costs arising from a manufacturing stoppage in Austin (Texas, USA).

The 2021 fiscal year was characterized by an unexpectedly swift economic recovery in China and a significant subsequent ramp-up in automotive production in the country.

[C19](#) Revenue and Segment Result of the Automotive segment

€ in millions

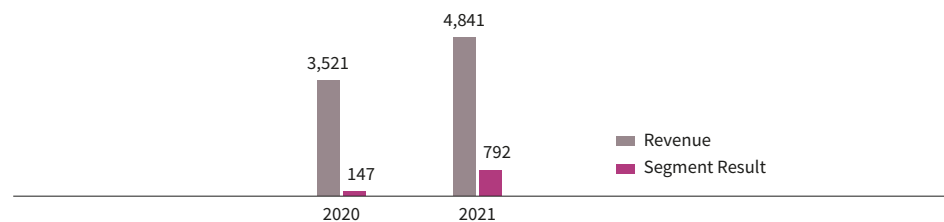

Particularly the purchase of electric vehicles showed a sharp increase in demand. This turn around, together with continuing high levels of demand for other semiconductor products in other sectors, led to an industry-wide chip shortage. Pandemic-related restrictions on the manufacturing capacity at our frontend and backend manufacturing partners exacerbated the difficult supply situation.

Electromobility and driver assistance systems continued to be the main drivers behind our growth in the 2021 fiscal year. Electromobility benefited not only from incentive schemes, but also from the increasing availability of charging stations, the wider range of models being produced by almost all vehicle manufacturers and from a change in attitude in society to sustainable technologies. During the reporting period, the first vehicle with our CoolSiC™ HybridPACK™ drive module also went into series manufacturing. As a result, we generated significant revenue from SiC for the first time in the automotive area. We won three additional contracts for SiC in the power train, so we can assume that over the coming years we will continue to achieve steady increases in revenue in this area.

Alongside power semiconductors, the second product category to achieve above-average revenue growth rates in the segment is microcontrollers, including the two families, AURIX™ and TRAVEO™.

Our system understanding, commitment to quality and the excellent service we provide all create added value for our customers and help them grow their businesses. In the 2021 fiscal year, we again received awards from several leading automotive manufacturers, in particular, recognition of our sustainable actions as well as excellent cooperation during this period of chip shortages. From the Chinese car manufacturer Great Wall Motor, for example, we received the Best Cooperation Contribution Award for exceptionally customer-oriented cooperation. A second example is the Excellent Contribution Award which we were given by FinDreams Technology Company, a subsidiary of the Chinese automotive manufacturer BYD. Thirdly, we received the Global Supplier Sustainability Award from the German automotive supplier Bosch for our climate-friendly actions. [\[See the chapter “Group strategy”, p. 41.\]](#)



REVENUE
€1,542 m

SEGMENT
RESULT
€275 m

Industrial Power Control

The Industrial Power Control segment specializes in semiconductor solutions for the intelligent management and efficient conversion of electric energy along the entire conversion chain: generation, transmission, storage and use. The product portfolio comprises mainly IGBT power transistors, driver ICs to control them, and power semiconductors based on SiC. The latter are becoming increasingly important for industrial applications. We offer the products in the Industrial Power Control segment, whether Si-based or SiC-based, in various form factors and with different levels of functionality. The segment's broad application spectrum includes motor control units for industrial manufacturing and building technology, inverters for photovoltaic and wind power systems, home appliances, traction, electric utility vehicles (such as buses and construction and agricultural vehicles), systems for high-voltage direct current transmission and energy storage, industrial power supplies and the charging infrastructure for electric vehicles. Our focus is on integration and digitization.

Applications  p. 241

Strategic focus

Power semiconductors are a key element in the products and systems of our customers, largely determining the function, efficiency, size, weight and cost of the systems. The products in our Industrial Power Control segment provide the foundation for the efficient generation, almost lossless transmission and storage of electric energy, on the one hand, and the reduction of losses on consumption, on the other. Our core business consists of discrete IGBTs and IGBT modules and the driver ICs associated with them.



Infineon offers IGBT modules for all power classes and all applications, from small industrial motors in household applications and fans in the kilowatt power range to conveyor drives in the hundreds of kilowatt power range to traction and pumps in the megawatt power range.

We want to continue to strengthen this core. We are constantly refining our existing products, combining them to create complete solutions for the customer. We leverage our economies of scale in research and development, as well as in manufacturing, and are therefore able to achieve a broad portfolio optimized for both cost and performance. In addition, we develop products that provide the opportunity for long-term differentiation.

Two examples of this are the following:

- › The PrimePACK™ module, which combines IGBT5 chip technology with the .XT bonding technology. While the IGBT5 chip technology allows higher power densities with lower static and dynamic losses, the .XT bonding and connection technology in the modules ensures a longer service life through improved thermal load cycling capability. This provides our customers with significant added value for high-power inverters in wind and photovoltaic applications and in industrial drives.
- › The products in the iMOTION™ family – which are basically application-optimized microcontrollers – enable easy-to-implement intelligent motor control. Infineon offers reference design solutions for these compact products, including connectivity solutions and components for human-machine interaction.

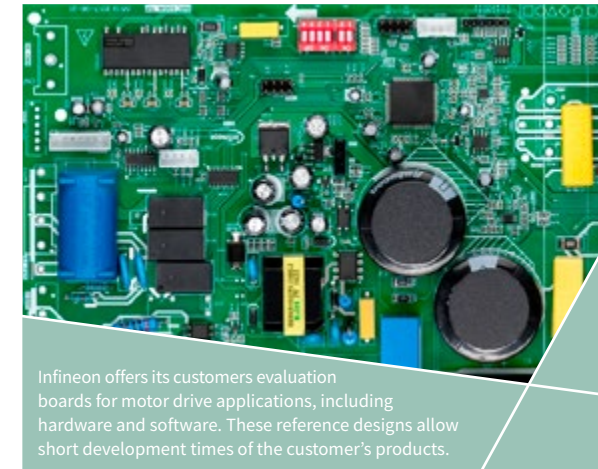

Infineon offers its customers evaluation boards for motor drive applications, including hardware and software. These reference designs allow short development times of the customer's products.

We are strengthening our product portfolio by using new materials. [See the chapter “Research and development”, [p. 82 f.](#)] The Easy module family is an important success factor here for fast market entry for the customer. It offers a flexible, easily scalable module solution with Si or SiC that is particularly effective in applications such as

photovoltaics, industrial automation and the charging infrastructure for electric vehicles. In addition to the modules, we are strengthening the volume production of our extensive product portfolios of discrete SiC MOSFET components. With our SiC products, customers can count on Infineon delivering the reliability for which it is known, as well as providing support to develop systems based on this new material.



The Industrial Power Control segment uses the expertise acquired in the application of discrete IGBTs and IGBT modules to unlock additional growth potential in adjacent product areas, such as Intelligent Power Modules (IPMs). The functional integration of drivers and power switches into our CIPOS™ IPMs helps our customers increase the efficiency of drives for small motors and therefore meet new energy efficiency standards for home appliances and industrial applications. These integrated products also enable a significant reduction in system size and development cost. We develop special control algorithms for the products in the iMOTION™ family mentioned above. Customers only need to adjust a few parameters within the algorithms to find efficient solutions to their problems.

Products in the iMOTION™ family are used in all types of home appliances, from hairdryers and washing machines to air conditioning units.

Looking across the segments, the Industrial Power Control segment benefits from the range of microcontrollers and connectivity and security solutions on offer in the Connected Secure Systems segment. This opens the door to new markets and additional growth potential in the application areas for which the Industrial Power Control segment is responsible.



With this expanded range, we can address a larger proportion of the semiconductor value in an application, which will enable us to continue to grow in our existing markets, while we can also offer our customers easy-to-use complete solutions. Understanding the newly acquired products and markets also enables us to expand the scope of our operations. We can see the potential for synergies, particularly in the areas of home appliances and factory automation (and here especially in robotics and driverless transport systems).



Software development is part of our strategic approach “Product to System”. In addition to hardware-near software such as firmware or drivers, we offer our customers other types of support. One example is IPOSIM (Infineon Online Power Simulation Tool), a program that helps the customer select the right product for a given application topology. It also simulates the switching and conduction losses, including an assessment of the thermal performance.





Market position

The world market for discrete power semiconductors and modules grew slightly by 0.4 percent in the 2020 calendar year to US\$20.896 billion. In the same period, Infineon increased its revenue by 3.1 percent. Therefore its market share saw a slight rise of 0.5 percentage points to 19.7 percent.  R03

The world market for discrete IGBT power transistors reached US\$1.586 billion in the 2020 calendar year,  R03. This was an increase of 10.9 percent compared with the figure for 2019 of US\$1.430 billion. Infineon's revenue in this area fell by 0.7 percent. With a market share of 29.3 percent, Infineon continued to be the clear market leader (2019: 32.7 percent),  C20. The five largest market players together accounted for 67.4 percent of the market (2019: 63.9 percent).

The world market for Intelligent Power Modules (IPMs) reached US\$1.429 billion in the 2020 calendar year,  R03. This was a decrease of 7.1 percent compared with the figure for 2019 of US\$1.537 billion. Infineon's revenue in this area fell by 9.4 percent. With a market share of 11.6 percent (2019: 11.9 percent), Infineon remained in 3rd position,  C21. The five largest market players together accounted for 78.3 percent of the market (2019: 79.0 percent).

The world market for IGBT modules reached US\$3.626 billion in the 2020 calendar year,  R03. This was an increase of 9.3 percent compared with the figure for 2019 of US\$3.316 billion. Infineon's revenue in this area increased by 12.6 percent. With a market share of 36.5 percent, Infineon continued to be the clear market leader (2019: 35.5 percent),  C22. The five largest market players together accounted for 66.7 percent of the market (2019: 68.5 percent).

C20 Market share for discrete IGBTs in the 2020 calendar year

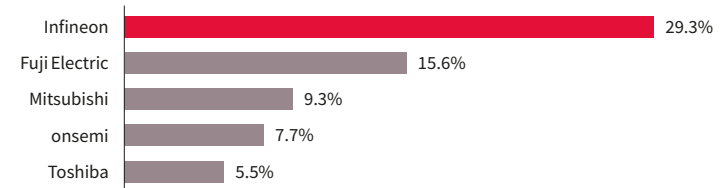

 R03

Comparability limited due to differing reporting period (fiscal year-end) and currency.

C21 Market share for IPMs in the 2020 calendar year

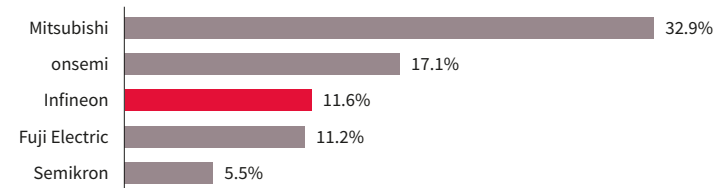

 R03

Comparability limited due to differing reporting period (fiscal year-end) and currency.

C22 Market share in IGBT modules in the 2020 calendar year

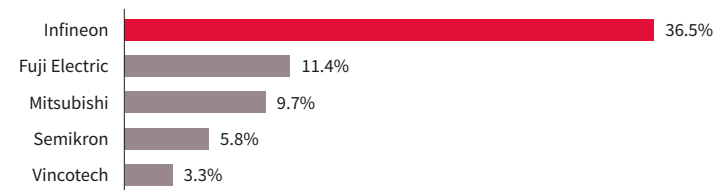

 R03

Comparability limited due to differing reporting period (fiscal year-end) and currency.

Review of the Industrial Power Control segment in the 2021 fiscal year

In the Industrial Power Control segment, Infineon generated revenue in the 2021 fiscal year of €1,542 million, which was an increase of 10 percent compared with the figure for the previous fiscal year of €1,406 million. The segment contributed 14 percent to Infineon's Group revenue.

The growth in revenue was driven by the strong recovery in the areas of automation, electric drives and home appliances, as well as by continuing growth in renewable energy and in the energy infrastructure, whereas there was a decline in revenue in the area of transportation. From a regional perspective, the Chinese market in particular contributed to this growth. Revenue increased by 21 percent and represent 55 percent of segment revenue.

In the 2021 fiscal year, the Segment Result was €275 million. This was an increase of 7 percent compared with the figure for the previous fiscal year of €256 million, **C23**. Despite the increase in revenue, the Segment Result Margin fell slightly to 17.8 percent (previous year: 18.2 percent), as the result was adversely impacted by costs arising from the coronavirus pandemic and by idle costs in the high power area.

C23 Revenue and Segment Result of the Industrial Power Control segment
€ in millions

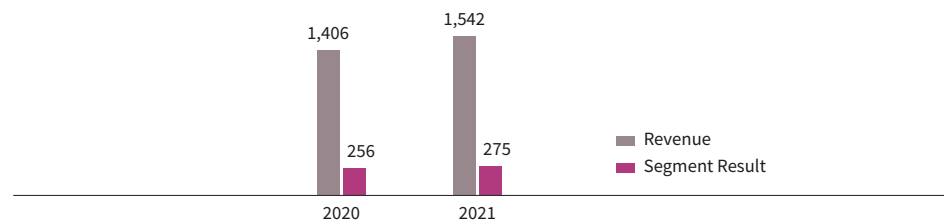

Demand in the area of automation and electric drives, the segment's largest field of application, recovered strongly from the impact of the coronavirus pandemic.

With 26 percent, the fastest rate of growth was to be seen in the area of renewable energy, which now accounts for 28 percent of segment revenue. The generation of clean energy is an essential prerequisite for the achievement of global carbon emission targets. Thanks to our strong market position in the area of renewable energy, Infineon is able to benefit directly from this megatrend.

There was a significant increase in revenue from products for wind power as well as from PV inverter products. In many regions of the world, solar and wind power are now the cheapest way of generating electricity. Capacity is therefore being expanded accordingly, especially in the form of utility scale installations.

The energy infrastructure business comprises the transmission, distribution and storage of energy, as well as the charging infrastructure for electromobility. This last area enjoyed particularly strong demand. In the 2021 fiscal year, Infineon's revenue from battery-based storage solutions was still low. However, as the proportion of renewable energy in the energy mix continues to grow, so does the importance of storage solutions to stabilize the grids. The energy infrastructure business represents 8 percent of the segment revenue.

In home appliances, the trend towards inverterized motor control systems continues. As a result of energy efficiency regulations, we expect demand for inverterized home appliances, especially air conditioning units and washing machines, to remain high over the coming years. Following a decline in demand in the previous year as a result of the coronavirus pandemic, revenue in this area increased substantially in the 2021 fiscal year.

Revenue in the transportation sector saw a significant decline. As a result of the coronavirus pandemic, passengers are using public transportation much less than usual. In many regions, expansion of transport capacity was postponed. New business areas such as the electrification of buses, trucks and farm machinery were unable to offset this decline.



REVENUE
€3,268 m

SEGMENT
RESULT
€823 m



Power & Sensor Systems

The Power & Sensor Systems segment encompasses a large selection of technologies relating to power semiconductors, radio frequency and sensors. We use these technologies to make electronic devices like power supplies, power tools, lighting systems, mobile devices and industrial and consumer applications smaller, lighter and more energy-efficient, as well as to develop new functionalities. We are drawing on the next generation of new, innovative solutions based on Si, SiC and GaN for applications in the areas of 5G, big data, power supplies and adapters, battery-powered devices, and renewable energy. Our portfolio of products for power supplies, comprising control ICs, drivers and MOSFET power transistors, addresses the two key requirements of the market: efficiency and power density. Infineon is the clear market leader in the global Si MOSFET market, [see C24](#). Our high-precision sensor solutions give IoT devices “human senses”, enabling them to react intuitively to their surroundings. The portfolio is rounded off with USB controllers and radio frequency products such as RF antenna switches, RF power transistors and GPS low-noise amplifiers.

Applications [p. 242](#)

Strategic focus

At the core of the Power & Sensors Systems segment are power semiconductors for power supply applications in the low and medium voltage range. The key requirements for power semiconductors are high efficiency levels, the best possible performance and a small form factor. Here, Infineon is able to offer solutions covering all the key active components of the system: i.e., control ICs, drivers and MOSFET switches. Currently, Si is the predominant base material for power switches, but now we are seeing a gradual trend towards increased use of power semiconductor products that are based on the new materials SiC and GaN. These result in far lower switching losses, which means that significant increases in efficiency and power density can be achieved. Digital controls are another factor contributing to improvements in performance. Power management is moving away from analog systems and becoming increasingly digital (Digital Power Management). Digital control ICs also allow for

greater functionality. The system therefore becomes more complex and higher-end, allowing Infineon's customers shorter development times for their own products. These functionalities have been further enhanced by the microcontrollers and connectivity solutions we added to our product portfolio when we acquired Cypress. Infineon is now offering its customers not only wireless connection technologies (Wi-Fi, Bluetooth and Bluetooth Low Energy) but also wired USB controllers, which transmit both signals and power.

Power & Sensor Systems' broad sensor portfolio allows machines and other electrical devices to communicate with their surroundings, depending on their situation. The various types of sensors emulate the human senses. MEMS microphones are a substitute for human ears, radar and time-of-flight (ToF) sensors provide 3-D vision, while gas sensors replicate the sense of smell. If the customer so wishes, any of these sensors can easily be combined with microcontrollers and connectivity solutions.





In the area of radio frequency, the company offers high-performance products for various special applications, such as amplifying the signal in cell phones and communicating between the cell phone and the base station. The portfolio includes RF antenna switches, RF power transistors, low-noise amplifiers, GPS signal amplifiers and transient voltage suppressor (TVS) diodes. The product portfolio is supplemented by GaN-on-Si power transistors for use in 5G base stations.



Both GaN and SiC are playing an increasingly important role in the area of power semiconductors. Using these new materials makes it possible to achieve further efficiency improvements here. In the case of SiC, 650 volt SiC switches are of particular interest to customers in the Power & Sensor Systems segment for use in their products. The applications these switches primarily address are servers, telecommunications and industry, solar energy systems, energy storage systems, motor drives and charging stations for electric cars. In the 2021 fiscal year, we have doubled our portfolio of 650 volt CoolSiC™ products. The portfolio now comprises 15 product types, including special SiC driver components that offer the customer optimal performance in combination with our SiC switches. Our existing portfolio of GaN products is also constantly being expanded. It currently comprises several switches in the 400 and 600 voltage classes. The main applications addressed by the existing portfolio are telecommunications, chargers and adapters, motor drives, servers, wireless charging and Class D audio amplifiers. A 650 volt GaN switch for use in the onboard chargers of electric cars is currently under development. There are plans to add 100 volt and 200 volt switches to the GaN portfolio in the near future. These could then be used, for example, in solar micro-inverters.



In May 2021, at the PCIM exhibition in Nuremberg (Germany), Infineon presented the first integrated product combining a CoolGaN™ switch in a system-in-package with a specially designed driver.



Market position

The world market for power MOSFETs, comprising standard MOSFETs, protected MOSFETs, SiC MOSFETs and GaN transistors, reached US\$8.114 billion in the 2020 calendar year,  R03, an increase of 0.1 percent compared with US\$8.105 billion in the previous year. Infineon's revenue in these product categories decreased by 0.4 percent in the 2020 calendar year. With a market share of 24.4 percent compared with 24.6 percent in the previous year, the company maintained its clear market leader position,  C24. The five largest market players together accounted for 58.4 percent of the market in the 2020 calendar year (2019: 59.7 percent).

The world market for power semiconductor ICs, comprising power management ICs, voltage monitoring ICs, drivers and voltage regulators, as well as controllers for switch-mode power supplies, power factor correction and battery management, was US\$24.326 billion in the 2020 calendar year. This was an increase of 0.6 percent compared with the figure for 2019 of US\$24.191 billion,  R03. Infineon's revenue in this area rose significantly by 6.8 percent. Hence the company improved its market share from 7.8 percent in the previous year to 8.2 percent in the 2020 calendar year and remained in 2nd place,  C25. The five largest market players together accounted for 43.4 percent of the market (2019: 43.2 percent).

The world market for MEMS microphones reached 5.976 billion units in the 2020 calendar year,  R04. This was an increase of 9.0 percent compared with the figure for 2019 of 5.482 billion units. Units sold by Infineon rose by 12.8 percent. Infineon continued to expand its market share, which rose from 42.7 percent in the 2019 calendar year to 44.2 percent in the 2020 calendar year, retaining the position as market leader it held in the previous year,  C26. The five largest market players together accounted for 95.4 percent of the market (2019: 95.1 percent).

C24 Market share for MOSFETs in the 2020 calendar year

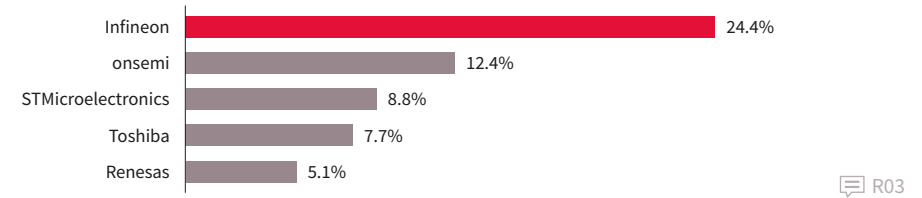

 R03

Comparability limited due to differing reporting period (fiscal year-end) and currency.

C25 Market share for power ICs in the 2020 calendar year

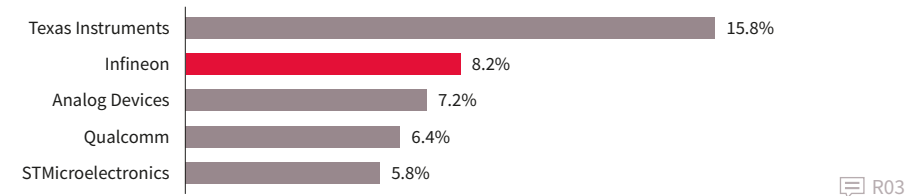

 R03

Comparability limited due to differing reporting period (fiscal year-end) and currency.

C26 Market share of MEMS microphones die suppliers in the 2020 calendar year (by units)



 R04

Comparability limited due to differing reporting period (fiscal year-end).

Review of the Power & Sensor Systems segment in the 2021 fiscal year

In the Power & Sensor Systems segment, Infineon generated revenue in the 2021 fiscal year of €3,268 million, an increase of 23.3 percent compared with the figure for the previous fiscal year of €2,650 million (which included the contribution to revenue made by Cypress from 16 April 2020 onwards), **▲ C27**. The segment contributed 29 percent of Infineon's Group revenue.

In the 2021 fiscal year, the Segment Result was €823 million, an increase of 29.4 percent compared with the figure for the previous fiscal year of €636 million. The Segment Result Margin improved from 24.0 percent in fiscal 2020 to 25.2 percent in the 2021 fiscal year. The main reason for the significant growth in revenue was the sustained rise in demand for semiconductors in a variety of applications. Another reason was the consolidation of Cypress' USB component business for the first time for a full fiscal year. The positive revenue trend also led to a further slight improvement in the Segment Result Margin.

C27 Revenue and Segment Result of the Power & Sensor Systems segment
€ in millions

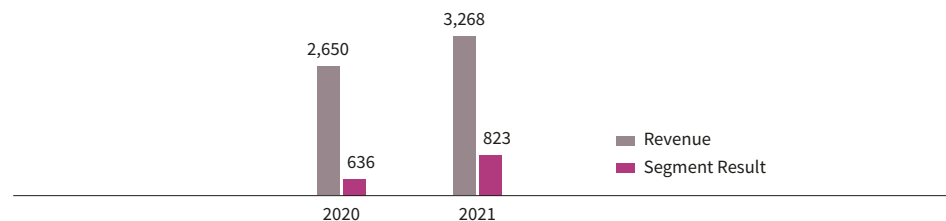

Growth in data volumes transmitted remained consistently high due to the persistent coronavirus pandemic and the resulting extent of virtual business conferences, working from home, home-schooling, online shopping and video streaming. In response, the expansion of server capacity and data centers continued undiminished in the 2021 fiscal year. In light of this development, many countries also expedited the expansion of their 5G cellular infrastructure.

Demand for battery-powered devices, games consoles and televisions also continued to develop positively. All these applications require a large number of power semiconductors, which has resulted in the increase in revenue in these areas.

Good revenue growth was also to be seen in the 2021 fiscal year in the area of radio frequency and sensor technologies. The greatest contributor to growth was our MEMS microphone business. Demand for microphones, not only for smartphones but also for the relatively new product group of wireless earphones with active noise cancellation, saw further strong growth. This growth was further supported by the use of these microphones in voice-controlled applications, such as smart speakers and remote controls for smart home devices.

The recovery in demand for 24 gigahertz radar sensor ICs also contributed to the increase in revenue. An important field of application for radar sensors with this frequency range is in blind spot detection systems for cars. Revenue from 3D time-of-flight sensors sold to smartphone and automotive customers stagnated in the 2021 fiscal year, remaining at the same level as in the 2020 fiscal year, while the company generated first revenue from gas sensors for measuring CO₂, newly launched onto the market in the 2021 fiscal year.

Revenue from radio frequency products, which comprise mainly RF power transistors for base stations, RF antenna switches and GPS low-noise amplifiers, also contributed to growth in this area.



Connected Secure Systems

The Connected Secure Systems segment provides comprehensive systems for a secure, connected world based on reliable, game-changing microcontrollers and wireless connectivity solutions and security solutions. In particular, we offer microcontroller solutions, Wi-Fi and Bluetooth solutions, and combined connectivity solutions (known as combo chips), along with hardware-based security technologies and an efficient software environment for the programming and configuration of the microcontrollers and connectivity components that cover many application areas: devices for IoT applications, connected home appliances and smart home appliances, IT equipment, consumer electronics, cloud security and connected vehicles, as well as credit and debit cards, electronic passports and national identity cards. With our technologies in the areas of computing, connectivity and security, we are contributing significantly towards ensuring that current and future connected systems are reliably protected, since communication and data security go hand in hand.

Applications  p. 243

Increasing digitalization unlocks new opportunities but increases the risks of hacker attacks or the violation of privacy if suitable countermeasures are not taken. With our expanded product portfolio and prefabricated solution components, we have strengthened our position, and we confirm our strategy, which is to support our customers in the best way we can by providing easy-to-use solutions for system integration and ensuring a short time-to-market.

In addition to its role as an independent business unit, the Connected Secure Systems segment fulfills a second important function within the Group. As a competence center, it helps the other three segments to integrate security, microcontrollers, connectivity and software as functions in their system solutions and thus to create additional potential differentiation between them and their competitors.

Strategic focus

The digital transformation is penetrating more and more areas of daily life. Digitalization is a key aspect of many applications. As a result of the acquisition of Cypress, we were able to expand our product portfolio and our competence portfolio in this area to include microcontrollers and connectivity solutions. IoT in particular offers us new opportunities for growth. Starting with consumer IoT, we will also continue to expand our IoT industrial applications. It is precisely these applications that require greater integration of security solutions into the design of intelligent devices, connected vehicles, companies and Industry 4.0 factories. The security aspect will continue to be imperative to provide defense against attacks – whether these involve theft of intellectual property or private data, fraud or manipulation.

One of the main reasons for the acquisition of Cypress was to strengthen our competencies and expand our portfolio in the area of microcontrollers (MCUs). Cypress' microcontroller business was brought together with Infineon's XMC™ family under one roof. This structure is helping us to combine forces and derive mutual benefit from the experience, knowhow, methods and tools brought to the table by both former parts of the business. Cypress' PSoC™ family of microcontrollers have traditionally had a greater presence in consumer and IoT applications. The strength of the XMC™ family of microcontrollers, on the other hand, lies in industrial applications such as motor drives, automation and communication, power conversion and LED lighting. Combining the two enables us to benefit from the synergies generated. Working together with other segments, we offer our customers tailored system solutions. In line with our strategic approach "Product to System", we incorporate security functions for example into special microcontrollers. We are thus expanding our portfolio, which has until now consisted of specialized security ICs, to include microcontrollers enhanced with security functions. This enables us to adapt even more specifically to the level of security desired by the customer. These are new features that differentiate us from our competitors and therefore provide us with growth opportunities.



Our product range now also includes hardware and software for connectivity solutions, developed by Cypress specifically for IoT applications. The portfolio comprises components for Wi-Fi, Bluetooth and BLE transmission standards. Together with industrial microcontrollers, these can be included in complete solutions not only for customers in the Connected Secure Systems segment, but also for customers in the Industrial Power Control and Power & Sensor Systems segments. To do so, products in the Industrial Power Control and Power & Sensor Systems segments are assembled in a manner specific to the application and combined using software components to create a complete solution in a compact form factor.

Cypress has had years of experience in software development and system knowhow, and it is precisely this that enables us to develop reference designs even faster for easy-to-use applications. This approach is important, because in the future there will be more and more customers whose products are acquiring IoT capabilities for the first time (i.e., they are “connected”), yet whose expertise does not lie in connecting their products to the internet. We want to be able to offer these customers turnkey reference designs that are tailor-made for their specific projects. As far as possible, we provide all the necessary semiconductor components and the software required to control our components. We therefore offer our customers ModusToolbox™, a software and development environment that is intuitive to use. ModusToolbox™ provides a modern software development approach based on an open-source system with prefabricated tools and seamless integration into the applications of third-party suppliers, so that developers can use the tools they wish and therefore easily design products tailored to their application. The application software remains the customer’s responsibility.



We have now expanded our core competence in security, originally acquired in traditional smartcard applications (payment cards and governmental identification documents), to cover the fast-growing area of embedded security applications and we have established ourselves as a provider of security solutions with a chip that functions as a highly reliable anchor for security. Software is becoming an increasingly important element of the solution we provide, right through to the complete product. We offer our customers solutions for secure authentication, encryption and protection against unauthorized access, all the way to complete system solutions for payment transactions or for PC protection.

For example, the SECORA™ pay portfolio comprises easy-to-integrate solutions for contactless payment cards and mobile devices. With SECORA™ Connect, the product family has been expanded to include a solution for coin cell-powered, connected smart wearables, such as smart watches. The solution combines a security module (Secure Element) with a system-in-package NFC antenna, facilitating the integration and management of payment applications for device manufacturers, as well as ticketing and access solutions. The basis for this is the secure digitization of credit or debit cards, referred to as tokenization, in the smartphone or smart watch.



Embedded security applications provide us with the opportunity to advance into new application areas, including for example authenticating devices for IoT applications and connecting vehicles, but also protecting smart factories in industry. Growth in this area is being driven by increasing data exchange. Vehicles, for example, send real-time traffic information to the cloud or receive updates from the manufacturer “over the air”, meaning that the software can be updated quickly and cost-effectively. The senders and recipients of these data, whether these are the vehicle manufacturers or individual systems in the vehicle, are authenticated using cryptographic keys. OPTIGA™ TPM stores this sensitive information in much the same way as if it were in a vault, providing particularly high levels of protection against data-technical and physical attacks. The Trusted Platform Module (TPM) secures all the major communication channels in the car, such as the central gateway, the telematic unit and access to the infotainment system. OPTIGA™ TPM can therefore be regarded as a successful example of our strategic approach “Product to System” and of collaboration across segment boundaries.



Market position

The world market for security ICs (excluding NFC controllers and NFC embedded Secure Elements) reached US\$2.779 billion in the 2020 calendar year,  R05. This was a decrease of 7.1 percent compared with the figure for 2019 of US\$2.991 billion,  C28. Infineon was able to retain its number 1 position, increasing its market share slightly from 24.4 percent in 2019 to 24.6 percent in 2020. The five largest market players together accounted for 85.1 percent of the market (2019: 81.0 percent).

The trends in the various submarkets were very different. The coronavirus pandemic encouraged the trend towards cashless payment. The largest submarket, security ICs for payment cards (US\$1.021 billion, down 2.0 percent), was virtually unchanged by this, whereas other submarkets such as governmental identity documents and health care cards (US\$388 million, down 12 percent) and security ICs for standard SIM cards (US\$500 million, down 16 percent) saw much more significant declines,  C29. Of all the submarkets, the fastest growth rate was to be seen in the embedded SIM market (US\$221 million, up 45 percent), a market which, though still small, is strategically important for us.

The world market for microcontrollers reached US\$17.283 billion in the 2020 calendar year,  R01. This was a decrease of 0.9 percent compared with the figure for 2019 of US\$17.448 billion. The five largest market players together accounted for 76.2 percent of the market (2019: 71.0 percent),  C30. The political tensions between the USA and China, on the one hand, and the production cutbacks in the automotive industry, on the other, had a significant impact on Infineon and thereof on the Cypress business. Infineon lost over 1 percentage point of market share (from 16.0 percent in 2019 to 14.7 percent in 2020), though it remained the third largest manufacturer of microcontrollers.

C28 Market share for security ICs (excl. NFC controller; excl. NFC embedded Secure Element) in the 2020 calendar year

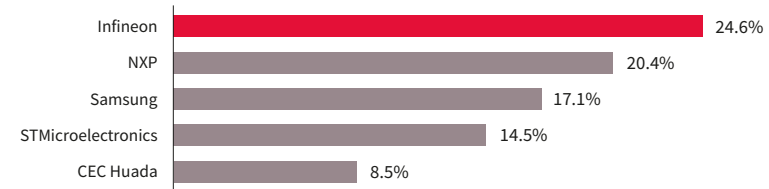

 R05

Comparability limited due to differing reporting period (fiscal year-end) and currency.

C29 Market share for security ICs (excl. NFC controller; excl. NFC embedded Secure Element) in the 2020 calendar year by application
US\$2.779 billion (minus 7.1% compared with 2019)

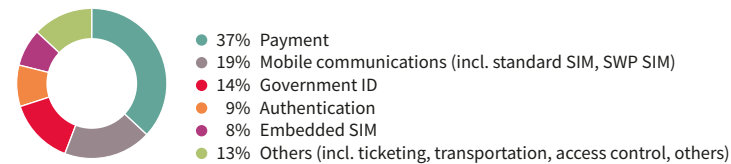

 R05

Comparability limited due to differing reporting period (fiscal year-end) and currency.

C30 Market share for microcontrollers in the 2020 calendar year



 R01

Comparability limited due to differing reporting period (fiscal year-end) and currency.

Review of the Connected Secure Systems segment in the 2021 fiscal year

In the Connected Secure Systems segment, Infineon generated revenue in the 2021 fiscal year of €1,397 million. Compared to the previous fiscal year figure of €974 million this corresponds with an increase of 43.4 percent for which a significant contribution to revenue was made by Cypress since 16 April 2020. The segment contributed 13 percent of Infineon's Group revenue.

In the 2021 fiscal year, the Segment Result was €182 million, an increase of 40.0 percent compared with the figure for the previous fiscal year of €130 million. Based on revenue, the Segment Result Margin was 13.0 percent (previous year: 13.3 percent). [C31](#)

The increase in revenue was due to an improved product mix and a full year's contribution from the business activities of Cypress. The Segment Result Margin remained largely stable due to increased operating costs. Usually there would have been scope for higher revenue volumes, but scarce foundry capacity meant that we were not able to meet in full the brisk demand for general-purpose microcontrollers and for Wi-Fi and Bluetooth components. In addition, there was the temporary shutdown of our manufacturing facilities in Austin (Texas, USA) caused by a winter storm, which further exacerbated the difficult supply situation.

C31 Revenue and Segment Result of the Connected Secure Systems segment
€ in millions

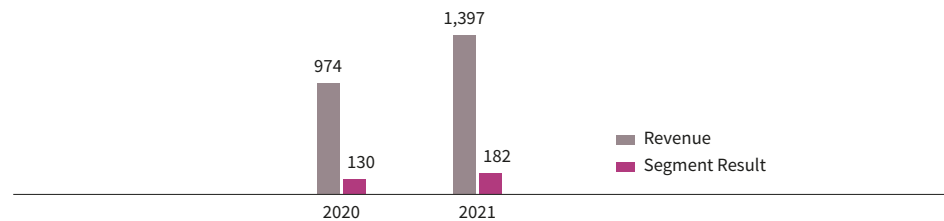

Demand for connectivity solutions and microcontrollers remained strong. People spending more time at home was one of the contributory factors here. Demand for Wi-Fi and Bluetooth components was driven by an increase in the penetration rate of end devices for wearables and smart home applications and in the automotive sector. Strong demand for microcontrollers was driven by industrial and consumer applications. Of particular note here are HMI applications, wearables and battery-powered applications.

The coronavirus pandemic has fueled the trend towards cashless and contactless payment. The shift from purely contact-based cards to dual-interface cards, accelerated by the pandemic, led to supply bottlenecks due to the high level of demand. We made progress in the area of biometric cards. On the security side, we announced a reference design for the next-generation biometric smart card architecture. This enables fingerprint authentication with low latency, high accuracy and power efficiency. The integration of the fingerprint sensor, and of the Secure Element, power management and communications reduces the complexity of card manufacturing, which shortens the time-to-market and lowers costs.

International travel started to pick up slowly in the second half of the fiscal year. Demand for passports slowly began to stabilize as a result. In many towns and cities around the world, the use of public transport declined due to multiple local lockdowns and to working from home. As a consequence of this, we continued to see weak demand for our transport and ticketing products.

Revenue from embedded SIMs (eSIMs), which are used in vehicles to make automatic emergency calls, increased once again. Demand for eSIMs in industry is also growing stronger, driven in particular by progress with Industry 4.0. manufacturing machinery, tools and other technical devices are increasingly connected and can therefore be monitored or serviced and maintained remotely.

Authentication products are gaining in importance, driven by the trend for working from home. There was a high level of demand in the 2021 fiscal year for a wide range of applications in this field, including printers and battery authentication.

Research and development



Research and development expenses were €1,448 million in the 2021 fiscal year compared with €1,113 million in the previous year. This increase of €335 million or 30 percent was in line with revenue. In the 2021 fiscal year, we invested 13.1 percent of revenue in research and development, compared with 13.0 percent in the previous year. Capitalized development costs in the 2021 fiscal year were €199 million (previous year: €158 million). Amortization of capitalized development costs in the 2021 fiscal year was €69 million (previous year: €56 million). Subsidies and grants received for research and development rose from €108 million in the 2020 fiscal year to €123 million in the 2021 fiscal year.

C32 R&D expenses
€ in millions

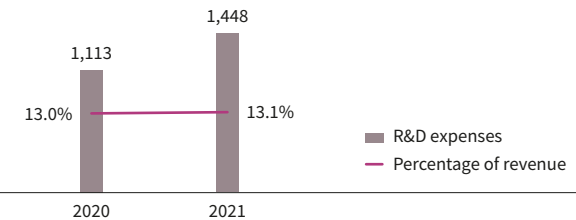

At the end of the 2021 fiscal year, we employed 10,372 people (21 percent of Infineon's total workforce) in research and development worldwide. At the end of the 2020 fiscal year, the corresponding figure was 9,262 (20 percent of the work-force). The number of research and development sites was 56 in the 2021 fiscal year (2020: 54 sites) in 20 countries.



Infineon's research and development activities accord with its strategy of securing and strengthening its core business and expanding its business in adjacent areas. Research and development activities therefore concentrate, on the one hand, on continuing improvements to our power semiconductors (with a particular focus on the use of new materials such as SiC and GaN) and, on the other hand, on the digitization of products and systems. The main development fields here are microcontrollers, connectivity solutions and software, and to an increasing extent artificial intelligence in edge computing. The ongoing development and expansion of our sensor range is a key factor in the area of IoT. We address longer-term future-related topics in the fields of quantum computing and post-quantum cryptography.

Patents

Another indication of Infineon's innovative power and long-term competitiveness is the number of our patents. As in the previous fiscal year, we applied for around 1,700 patents worldwide in the 2021 fiscal year. We regularly review and streamline our patent portfolio. At the end of the 2021 fiscal year, the worldwide patent portfolio comprised around 29,500 patents and patent applications (previous year: around 29,000).

Research and development fields at Infineon

The strategic approach "Product to System" (P2S) is of crucial importance here in more than one respect. It helps us to better adapt our components to requirements. We understand new trends early on and can develop innovative approaches to the point that we can suggest new courses of action to our customers, or we can present them with completely new possibilities. Particularly important is the opportunity to offer customers all-in-one solutions. This provides them with benefits in terms of system performance, system costs and development time. This approach also means that we are increasingly focusing on and building more expertise in software and system solutions.

Fast charging stations for electric vehicles illustrate the P2S approach. Infineon supplies the relevant semiconductors in a system solution that includes not only Si-based or SiC-based power semiconductors, but also driver ICs, sensor solutions, communications components, and microcontrollers with integrated security solutions. [▶▶ C33](#)



Based on this broad portfolio and our system understanding at application level, we support customers in a number of ways in the design of a high-performance solution. Our input includes reference designs, simulations, podcasts, blogs and videos.

In this way, the customer can

- > increase the power output to shorten the charging time,
- > improve the power density of the charging station within specified dimensions,
- > increase efficiency through lower switching losses and line losses, and
- > reduce product costs per watt.

C33 Infineon owns the key components for xEV charging stations

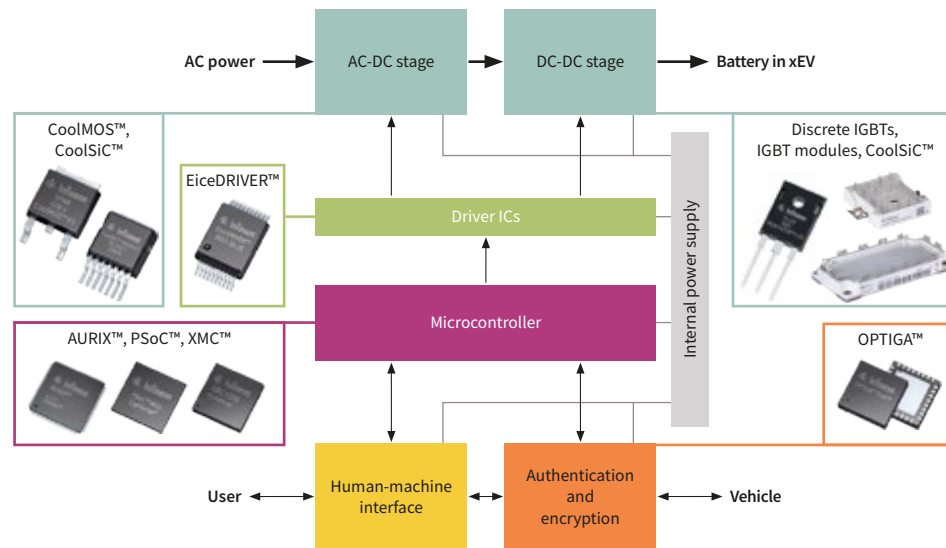

New materials

Manufacturing technologies and transistor architectures for power semiconductor components based on new materials are a key focus of our research and development activities. SiC, a compound of silicon and carbon, and GaN, a compound of gallium and nitrogen, enable higher power densities and low switching losses, both of which contribute towards improved efficiency of power electronic systems and therefore to reduced losses. Whereas SiC is used especially for voltages exceeding 600 volts, GaN is favored for lower voltages, where it can play to its particular strength, extremely low switching losses. The three materials (SiC, GaN and Si) all complement each other, with each one suitable for particular applications and requirements.

SiC

The market for SiC is growing at an extremely dynamic pace. Demand was initially determined by industrial applications such as photovoltaic inverters, industrial power supplies and the charging infrastructure for electric vehicles, but this is now being surpassed by demand for automotive applications. Specifically, the new solutions are being used for the drive train and onboard chargers.

In the 2017 calendar year, Infineon was one of the first manufacturers to bring a SiC MOSFET with trench technology to market. Trench architecture offers significantly more opportunities for the realization of efficient, robust transistors than technically less demanding planar architecture. It gave Infineon a competitive edge on the development front, which we want to sharpen with the second generation currently in development.

Building on our comprehensive system understanding, we develop new tailor-made solutions with our key customers. We are also expanding our product portfolio to include additional voltage classes. Suitable packages will also be produced, so as to exploit SiC technology to the full.

At the beginning of the 2019 fiscal year, we acquired Siltecta in order to address the high cost of the base material, the SiC wafer. We plan to use Siltecta's Cold Split technology on an industrial scale in the 2022 fiscal year. In the first phase, boule splitting takes place. This technology enables crystalline materials to be split with minimum loss of material compared with conventional sawing techniques, which will make it possible to produce significantly more wafers from one boule. The second phase in the manufacturing is wafer splitting. In this process, the raw wafers we purchase are split in two, effectively doubling our output. Advanced development of the Cold Split technology is taking place in Villach (Austria) and at the Siltecta site in Dresden (Germany).

GaN

Compared to Si-based transistors, GaN-based transistors also have advantages that make them useful in areas such as power supplies and chargers. Devices that are more efficient and much more compact can be built due to lower losses both when switching and when in the on-state. GaN's properties, which are very different from those of Si, make it possible to integrate high-voltage systems on a chip, which represents another step towards more compact solutions. These can be used, for example, in motor control units in robots, where high dynamics and small form

factor are important. Another field of application is data centers, which have very high requirements in terms of energy efficiency and power density.

In the 2021 fiscal year, our product portfolio was expanded with the launch of a GaN power semiconductor IC. This IC, which is called CoolGaN™ Integrated Power Stage 600 V, comprises for the first time a driver IC and a switch in one package. The high degree of switch integration means that the advantages of GaN technology can be combined with simple control. With this product, we are primarily addressing applications such as USB PD chargers, adapters, and low to medium-power switch-mode power supplies. We will be expanding our product range in the medium to long term to include discrete and integrated solutions with additional voltage classes in the high-to medium-power range. Moreover, we are expanding our package portfolio.

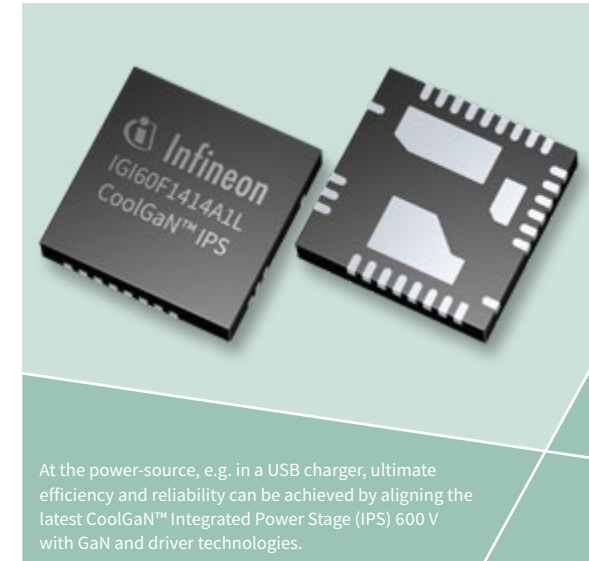

Microcontrollers

Microcontrollers are key elements of every electronic system. In the automotive sector, the highly successful microcontrollers in the AURIX™ family, with their focus on the powertrain (motor control/inverters/transmission/charging systems), security components and automated driving, have been supplemented by those in Cypress' TRAVEO™ family, with their focus on infotainment and body functions. For industrial applications, Cypress' PSoC™ family has been added to the product range. Both TRAVEO™ and PSoC™ are product families that build on Arm® processor architecture and therefore reach a wide developer community.

Software and system support

Software development is playing an increasingly important role in Infineon's research and development. It is a significant part of our strategic approach "Product to System", which involves presenting the customer with comprehensive and easy-to-use solutions. Traditionally, we develop hardware-near software like firmware or drivers. In addition, for more and more applications, we are now offering application-related program codes. The dynamic IoT market offers great potential. Here especially, aspects that are important to the customer are short development times and little need for modification, combined with a high degree of IT security. This requires not only individual software elements, but also a comprehensive software development environment.

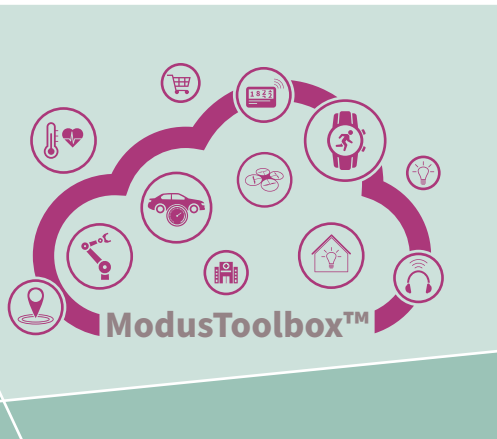

The acquisition of Cypress brought us for the first time a complete ecosystem, including the ModusToolbox™ development environment, software components and an active developer community. The ModusToolbox™ comprises, among other things, reusable firmware, which makes programming Wi-Fi and Bluetooth components, microcontrollers and sensors significantly easier for the engineers. In addition, we have launched the ModusToolbox™ ML. ML stands for machine learning (i.e., artificial intelligence methods).

Developing our own software has other advantages. We can ensure the software and hardware are a perfect match, thus optimizing performance, energy efficiency and data security at the system level. We can generally differentiate our solutions from those of our competitors not only through our hardware, but also through software we have written ourselves and/or programmed algorithms.

Artificial intelligence

Infineon uses artificial intelligence (AI) methods in many areas such as development, production and marketing. In the area of manufacturing, examples include automated visual fault detection and predictive maintenance. Around the world, many teams from different functions are involved with the use of AI in their working environment. Since 2017, Infineon has had local teams of experts who use AI to optimize manufacturing. Our development center in Dresden for AI in our products started up in 2018. In 2020, we set up our Center of Excellence for AI in Munich (Germany) for the global coordination of our AI activities. This was followed in 2021 by our ARISE initiative in Singapore.

With our products and the use of AI, we make completely new applications and forms of human-machine interaction possible. Using our modern sensors, machines acquire spatial hearing or the ability to see in 3D, or the capacity to feel or to analyze gases. These abilities correspond to the human senses, which makes the machines intuitive to operate. Edge AI (artificial intelligence within a device or on the edge between the device and the cloud) opens up the possibility of many new applications. AI in the cloud, which has prevailed until now, is easily scalable but has the disadvantage of high electricity consumption and also requires a reliable data connection.

Infineon develops hardware solutions and software solutions so that AI algorithms can be used in integrated systems. In addition to optimizing the hardware of existing architectures, this also includes specific AI accelerators with extremely low electricity consumption. These are used, for example, in keyword and gesture recognition, object identification and classification, and sensor fusion. The prerequisite for this is an understanding of the algorithms of neural networks so that these can be implemented in special semiconductor components in switching circuits (i.e., in hardware). As a result, an enormous speed advantage can be achieved with reduced electricity consumption compared with a software-based solution. Our aim is to develop complete solutions in the area of sensors, AI accelerators, microcontrollers and software. AI is a key element of our software expertise.

In many areas of digitalization, values-based trustworthy AI offers an opportunity to provide people with support, while at the same time preserving personal freedom. If people's wellbeing and dignity are to remain at the heart of all AI-based applications in the future, ethical guidelines governing the deployment and use of AI will be required. This insight also underlies the new EU Regulation governing AI. The Draft Regulation published in April 2021 includes a risk-based approach that regulates the supply and operation of AI systems. Applications that conflict with the norms and values of the EU will simply be banned. These include, for example, systems that can be used by governments for social scoring activities. High-risk applications have to fulfill specific conditions regarding data protection, transparency and operability. As a company, we endorse a value-based approach that takes ethical aspects into consideration when dealing with AI and, at the same time, makes innovation and development possible. Infineon is also involved in various cross-company initiatives, sometimes politically coordinated, such as Applied.AI and the "Learning Systems" platform launched by the German Federal Ministry of Education and Research (BMBF).

Sensor technologies

Sensors capture the real analog world. The signals measured are first digitized. Then, the digital values are processed, transmitted and stored according to the requirements of the target application. Sensors also play an increasingly important role in operating machines and devices, referred to as human-machine interaction. In the 2021 fiscal year, together with our partner Reality AI, we launched a new sensing solution for the automotive sector onto the market. It combines XENSIV™ MEMS microphones with AURIX™ microcontrollers and Reality AI's Automotive See-With-Sound system. Using machine learning-based algorithms, the system is able to detect emergency vehicles, cars and other road users, even if they cannot be seen by the driver. AI also ensures that the country-specific sirens of emergency vehicles are recognized in all parts of the world.

In the field of intelligent building control, Infineon is offering a new CO₂ sensor. CO₂ is a key parameter for indoor air quality, which directly correlates with the aerosols via

which coronavirus, for example, is transmitted. Smart ventilation and warning systems equipped with the XENSIV™ PAS CO₂ sensor warn of poor air quality or ensure the supply of fresh air necessary if they are linked to the air conditioning system. The XENSIV™ PAS CO₂ measures the CO₂ content in the indoor air extremely accurately on the basis of photoacoustic spectroscopy (PAS). To do so, it uses a highly sensitive acoustic detector optimized for low frequency operation. The PAS principle enables a significant reduction in the form factor of up to 75 percent compared to customary CO₂ sensors.

Connectivity solutions

Cypress' Wi-Fi and Bluetooth solutions are already well-established in various markets. The current main applications are in consumer products and IoT, including intelligent loudspeakers (smart speakers), activity trackers and printers, as well as in the automotive sector. Customers' needs in many applications are met primarily as a result of our ability to integrate Wi-Fi and Bluetooth technologies on combo chips, as well as the option we can provide of highly integrated dual stream 2x2 Wi-Fi components to fulfill complex system requirements.

Our future developments under the umbrella of the Connected Secure Systems segment are focusing, on the one hand, on the next generation of integrated Wi-Fi, BT and BLE products and, on the other hand, on the incorporation of these new connectivity capabilities into our existing and future range of products and systems in the markets and applications we address.

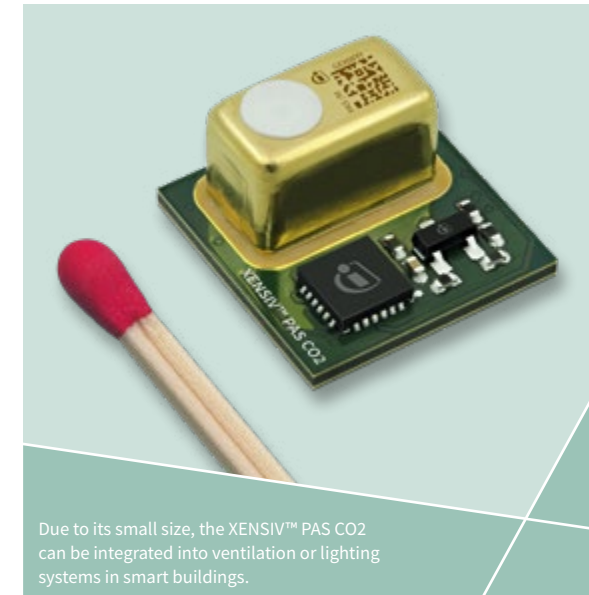

Due to its small size, the XENSIV™ PAS CO₂ can be integrated into ventilation or lighting systems in smart buildings.

Innovative memory solutions

Through its acquisition of Cypress, Infineon acquired additional expertise in various memory technologies. The most important of these for Infineon are NOR Flash memory ICs, which have a wide range of potential applications in the automotive sector, industry and the communications infrastructure. A NOR Flash memory IC is used primarily as program memory and is therefore distinguished from NAND Flash memory, which is used for (multimedia) data. Infineon's NOR Flash memory ICs offer immediate availability in the systems used, a sort of "instant on".

Quantum computers and post-quantum cryptography

The active use and precise manipulation of quantum mechanical effects in a few or individual particles is a basis for innovative components that may be significant for future industrial products. Above all, the field of quantum computing is thought to have disruptive potential, as this new computing architecture will enable the solution of types of problems that have, until now, hardly been accessible. Problems of such complexity occur, for example, in materials research, drug development, weather forecasting and logistics optimization. Infineon is a sought-after partner in this highly innovative field. Above all, in research networks both inside and outside Germany, it contributes its expertise in the planning, design and manufacture of special technologies and/or special components. On 10 June 2021, ten leading German companies presented the Quantum Technology and Application Consortium (QUTAC) to the public. On board with Infineon are BASF, BMW, Boehringer Ingelheim, Bosch, Merck, Munich Re, SAP, Siemens and Volkswagen. Together we will continue to build on the existing foundations of quantum computing in order to move into industrially useful fields of application.

In the 2021 fiscal year, Infineon presented the prototype of an industrially manufactured ion trap quantum chip. The 2x9 ion quantum processor is a pilot designed to show how to implement the industrial manufacturing chain of an ion processor from conception to application. Our manufacturing expertise, combined with strong academic partners at the University of Innsbruck (Austria) and ETH Zurich (Switzerland), is enabling the rapid ongoing development of our first prototypes. In addition, Infineon is driving forward the development of other technological

approaches and is developing both superconductive components and spin-based systems in SiGe structures for future quantum computers.

Even if quantum computers are only available in some years' time, this already has practical consequences today. The service life of major systems or products, such as passports, industrial facilities, medical technology and cars, will potentially extend into the era of quantum computers, and these systems and products will still need to be secure at that time. Established encryption technologies could be attacked and broken with quantum computers. For this reason, Infineon is focusing on post-quantum cryptography to start developing solutions now with security chips that will be able to resist the computing power attacks of quantum computers. Infineon sits on a number of committees involved in setting international standards in this field.

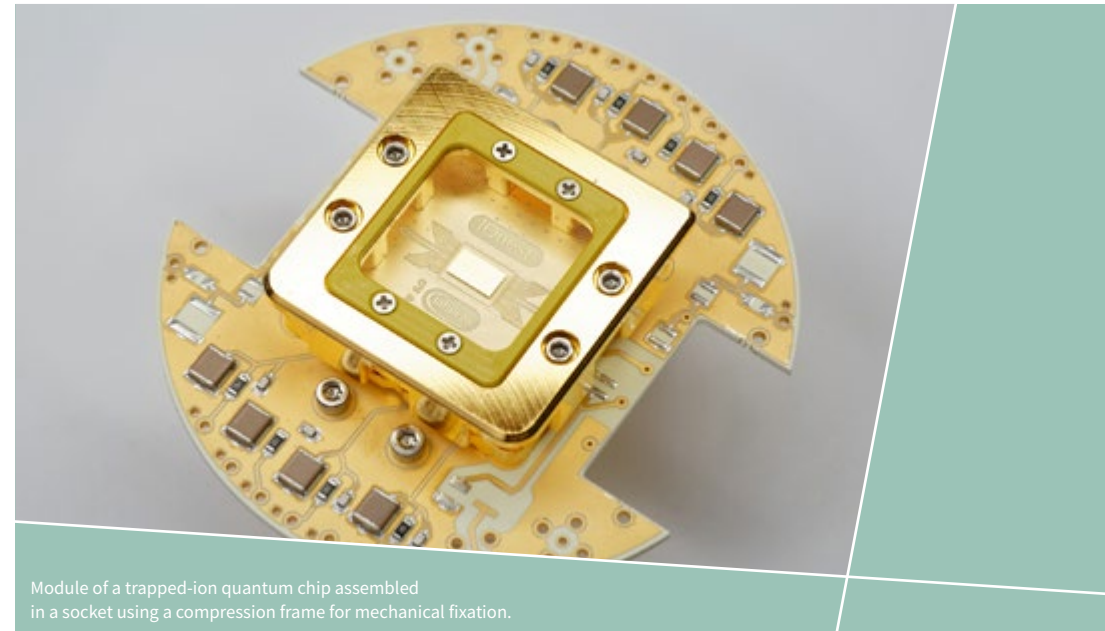

Module of a trapped-ion quantum chip assembled in a socket using a compression frame for mechanical fixation.

R&D sites

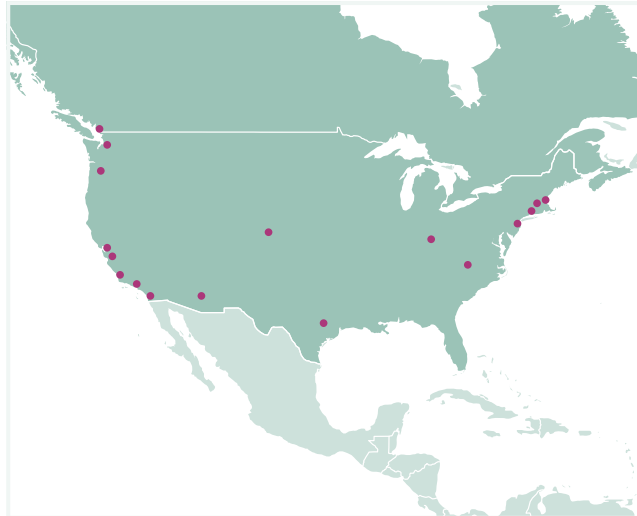

America

Canada

- > Richmond, BC

USA

- > Andover, MA
- > Austin, TX
- > Beaverton, OR
- > Chandler, AZ
- > Colorado Springs, CO
- > El Segundo, CA
- > Hazlet, NJ
- > Irvine, CA
- > Leominster, MA
- > Lexington, KY
- > Lynnwood, WA
- > Milpitas, CA
- > San Diego, CA
- > San José, CA
- > Warwick, RI



Europe, Middle East, Africa

Austria

- > Graz
- > Linz
- > Villach

Denmark

- > Herlev

France

- > Le Puy-Sainte-Réparate

Germany

- > Augsburg
- > Dresden
- > Duisburg
- > Erlangen
- > Langen
- > Martinsried
- > Neubiberg
- > Regensburg
- > Warstein

Ireland

- > Cork
- > Dublin

Israel

- > Netanya

Italy

- > Padua
- > Pavia

Romania

- > Bucharest

UK

- > Bristol
- > Reigate

Ukraine

- > Lviv

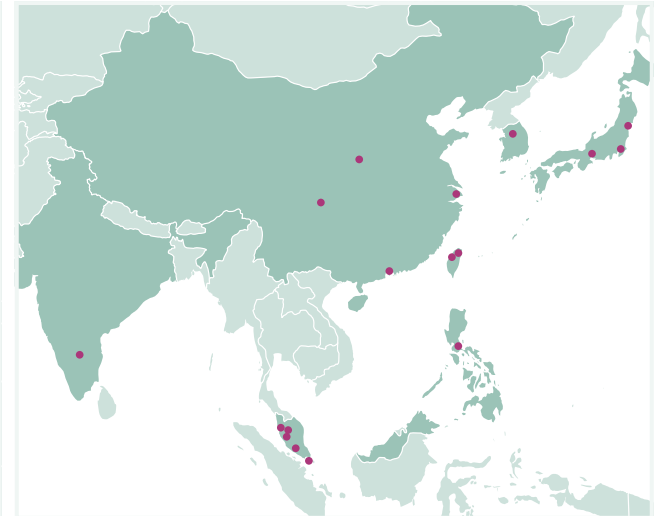

Asia-Pacific

India

- > Bangalore

Korea

- > Seoul

Malaysia

- > Ipoh
- > Kulim
- > Melaka
- > Penang

Philippines

- > Muntinlupa

Singapore

Greater China

- > Chengdu
- > Shanghai
- > Shenzhen
- > Xi'an

Taiwan

- > Hsinchu
- > Taipeh

Japan

- > Nagoya
- > Sendai
- > Tokyo

Manufacturing



In the 2021 fiscal year, our investments amounted to €1,497 million. This was an increase of €398 million, or 36 percent, compared with the €1,099 million invested in the previous year. This increase is slightly stronger than our revenue increase and a result of a strong recovery in demand. Investments as a proportion of revenue increased from 12.8 percent in the 2020 fiscal year to 13.5 percent in the 2021 fiscal year. Of the total investments, €1,268 million related to property, plant and equipment (previous year: €915 million) and €229 million to other intangible assets, including capitalized development costs (previous year: €184 million).

C34 Investments¹

€ in millions

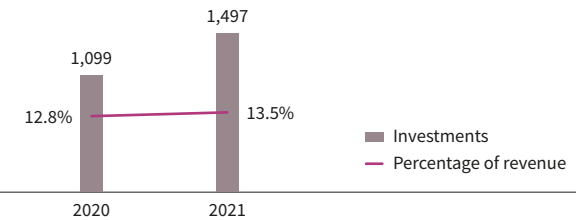

¹ Property, plant and equipment and other intangible assets.

By far the largest share of investments in property, plant and equipment was dedicated to manufacturing. Of this, the larger part was invested in frontend operations and the smaller part in backend operations.

As of 30 September 2021, there were 33,699 people employed in manufacturing-related functions (previous year: 31,292 employees). The increase reflects the capacity expansion and higher plant utilization rate. We reduced the number of manufacturing sites to 20 in 13 countries, compared with 21 manufacturing sites in 13 countries at the end of the 2020 fiscal year.

Manufacturing strategy

In its in-house manufacturing, Infineon focuses on differentiating technologies. In frontend manufacturing, these include, in particular, power semiconductors and sensors, while in backend manufacturing they include the associated modules. We use external manufacturing partners in the frontend phase for CMOS and CMOS-derivative technologies. This applies to technology nodes of 65 nanometers and smaller but also to older generations of power semiconductors. In the backend area, particularly in assembly and testing, we are making increasing use of manufacturing partners for standardized package types.

The relatively high proportion of in-house manufacturing has a number of advantages:

- › Our manufacturing sites benefit from economies of scale. Our 300-millimeter thin wafer production enables us to create differentiated products, is cost-effective and ensures a high level of quality.
- › We use the opportunities presented by in-house manufacturing to develop new materials to suit the needs of the market, such as SiC and GaN, which involves close collaboration between manufacturing and development.
- › Close cooperation between chip design and manufacturing generally enables short development times and a high level of flexibility.
- › Infineon is able to control a large part of the supply chain itself.

This final point particularly paid off when the chip shortage started to bite towards the end of 2020 and beginning of 2021. Past investment enabled us to be relatively successful at meeting customers' needs in that very fast-moving market environment.

Certainly, the allocation situation in the fiscal year just ended was particularly difficult for products that we purchase from foundries (frontend). To ensure delivery capability in the future, we therefore concluded several long-term supply contracts with foundries in the course of the 2021 fiscal year.

Start-up of the 300-millimeter factory in Villach

Manufacturing commenced at the new 300-millimeter factory on the Villach site in Austria in the fiscal year just ended, around three months ahead of schedule. At a big opening ceremony attended by many politicians, including the Austrian Chancellor and several secretaries of state, the first finished wafer was presented. Over the coming four to five years, the areas in the clean room will be fitted with production facilities. The total planned investment for the fully equipped buildings and clean room facilities is around €1.6 billion. The development of the Villach site will generate significant economies of scale and revenue potential of around €2 billion per year.



With the new 300-millimeter factory on the Villach site in Austria in conjunction with our manufacturing facility in Dresden (Germany), we are establishing the concept of manufacturing control spread over different locations. Villach and Dresden will use the same processes and plants and the same automation and digitalization concepts. As a result, we will achieve greater manufacturing flexibility and shorter development times. Furthermore, shared learning will enable a fast and seamless transfer of technology between sites and have a positive impact on productivity and on the stability of our manufacturing.

Other investment focus areas in manufacturing in the 2021 fiscal year

Capacity for SiC and GaN continues to be expanded on the Villach site. Existing buildings and manufacturing lines can be reused for these compound semiconductors, enabling us to achieve capital-efficient capacity expansion. This makes it possible for the further ramp-up of volume production of our SiC MOSFETs in trench technology and SiC diodes on 150-millimeter SiC wafers.

The 300-millimeter factory in Dresden is continuing to be fitted with production facilities. Investment in our Malaysian frontend site in Kulim is focusing on MEMS microphone technology and our power semiconductors.

In Cegléd (Hungary), the construction of the building for a new module manufacturing facility was completed and “ready for equipment”. Moreover, in February 2020, construction started on the new manufacturing facility at our largest backend site, in Melaka (Malaysia), which will focus on automotive power semiconductors.

The planned sale or closure of the site in Temecula (California, USA) has been postponed to the end of the 2022 fiscal year so that we can respond to current demand as far as possible. The products manufactured there will be transferred to other Infineon sites or outsourced for manufacturing to external partners.

Impact of the coronavirus pandemic, the winter storm in Austin (Texas, USA) and the power cut in Dresden on supply and manufacturing chains

The spread of the coronavirus pandemic is still presenting challenges for our supply and manufacturing chains. In the fiscal year just ended, we had production losses in our backend manufacturing in Malaysia in particular, as a result of flare-ups of coronavirus infections. Thanks to the use of extensive hygiene protocols and the administering of vaccinations to employees, as well as our classification as a system-relevant industry, we were given permission to continue, for the most part, with our manufacturing.

In February 2021, a severe winter storm in Austin resulted in power outages and interruptions to gas and water supplies. Following a pause in manufacturing, production increased over the following months, and the facility was back to full capacity by July.

In September 2021, a 20-minute power cut in Dresden led to an interruption in production. Manufacturing was ramped up again in the following weeks.



The Villach site in Austria with the new 300-millimeter chip factory (large building, back left) and the new research and development building (front center).

Manufacturing sites

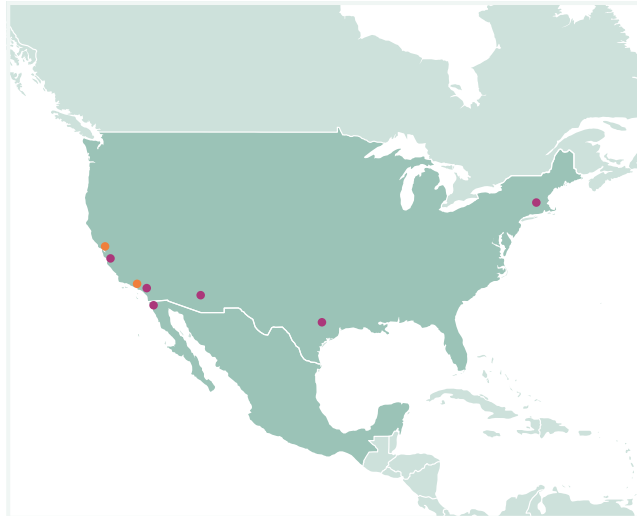

AMERICA

Mexico

- > Tijuana
Backend manufacturing

USA

- > El Segundo, CA
Regional headquarters
- > Milpitas, CA
Regional headquarters
- > Austin, TX
Frontend manufacturing
- > Leominster, MA
Backend manufacturing
- > Mesa, AZ
Frontend manufacturing
- > San José, CA
Backend manufacturing
- > Temecula, CA²
Frontend manufacturing

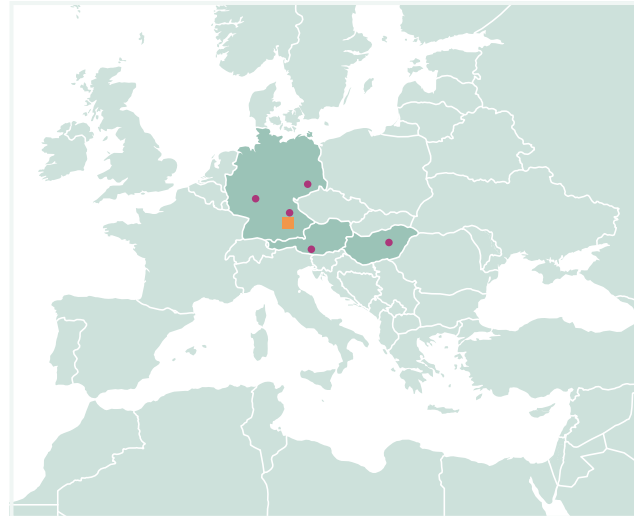

Europe, Middle East, Africa

Austria

- > Villach
Frontend manufacturing

Hungary

- > Cegléd
Backend manufacturing

Germany

- > Neubiberg
Corporate headquarters
- > Dresden
Frontend manufacturing
- > Regensburg
Frontend and backend manufacturing
- > Warstein
Backend manufacturing



Asia-Pacific

Singapore

- > Regional headquarters;
Backend manufacturing
(test only)

Indonesia

- > Batam
Backend manufacturing

Korea

- > Cheonan
Backend manufacturing

Malaysia

- > Kulim
Frontend manufacturing
- > Melaka
Backend manufacturing
- > Penang¹
Frontend manufacturing

Philippines

- > Cavite
Backend manufacturing

Thailand

- > Bangkok
Backend manufacturing

Greater China

- > Shanghai
Regional headquarters
- > Wuxi
Backend manufacturing

Japan

- > Tokyo
Regional headquarters

■ Corporate headquarters ● Regional headquarters ● Frontend and backend manufacturing

For definition frontend/backend manufacturing [p. 51](#)

¹ Penang is assigned to the Austin site. The Known Good Die (KGD) test takes place in Penang.

² The site in Temecula will be closed in the 2022 fiscal year.

Internal management system

The internal management system at Infineon is designed to help implement Group strategy, [p. 35 ff.](#), and the related long-term financial targets, [p. 45 f.](#) Accordingly, performance indicators are used that enable profitable growth and efficient employment of capital to be measured.

Overall, the achievement of our long-term financial targets will lead to a sustainable increase in the value of the Company by generating a permanent premium on the cost of capital.

In this context, growth, profitability and investments are all interdependent. Profitability is the prerequisite for being able to finance operations internally, which, put another way, means opening up potential opportunities for growth. Growth, in turn, requires continual investment in research and development as well as in manufacturing capacities. Growing at a commensurate rate enables Infineon to achieve leading market positions and generate economies of scale that contribute to greater profitability. Employing financial resources efficiently is a critical factor in achieving these goals.

Infineon deploys a comprehensive controlling system to manage its business with respect to the strategic targets it has set itself. The system involves the use of financial and operating performance indicators. Information for controlling purposes is derived from annual long-term planning, quarterly outlooks, actual monthly data and information available on a weekly basis, such as the volume of orders received. This knowledge enables management to base its decisions on sound information with respect to the current situation and future expected financial and operational developments. Sustainable business practices and the consideration of forward-thinking qualitative factors are important for Infineon's long-term success. As an enterprise very much aware of its responsibilities towards society, Infineon also takes account of non-financial factors, mainly in the field of environment and regarding diversity of employees. [See the report "Sustainability at Infineon" on our website www.infineon.com/csr_reporting] Although these factors are not used to manage business performance, they nevertheless help Infineon achieve its financial targets.

As part of the process of managing business performance, management also attaches great importance to ensuring that Infineon acts in strict compliance with all relevant legal requirements and, of equal importance, that its internal Corporate Governance Standards are complied with (see the chapter "Corporate Governance", [p. 128 ff.](#)).

Performance indicators

Principal performance indicators

In order to measure its success in implementing its strategies, Infineon uses the following three principal performance indicators:

- › **Segment Result** and Segment Result Margin
- › **Free Cash Flow** from continuing operations and
- › **Return on Capital Employed (RoCE)**

The three performance indicators described above are also the cornerstones of the system for variable remuneration. Most of the variable salary components pertaining to employees and management are directly linked to these performance indicators.

Segment Result

Segment Result is the key figure of the Group for measuring operating performance (for an analysis of the development of Segment Result of Infineon and the individual segments in the 2021 fiscal year, see the chapters "The segments", [p. 58 ff.](#), and "2021 fiscal year", [p. 56](#)). Expressed as a percentage of revenue (Segment Result Margin), it measures the profitability of revenue and shows how well operations are being managed. The activities of Infineon's segments are managed on the basis of Segment Result. Responsibility for optimizing Segment Result within the framework of Group strategy (as approved by the Management Board) rests with the management teams of the relevant segments, acting, however, in close coordination with the Management Board.

Segment Result is defined as follows:

Operating profit, adjusted for:
Net of certain reversal of impairments and impairments (in particular on goodwill)
Impact on earnings of restructuring and closures, net
Share-based payment
Acquisition-related depreciation/amortization and other expense
Other expenses
Impact on earnings of sales of businesses, or interests in subsidiaries
Net of other income and expense
= Segment Result

Free Cash Flow

Free Cash Flow measures the ability to generate sufficient cash flows to finance day-to-day operations and fund required investments out of the ongoing business. It is Infineon's stated target to sustainably generate positive Free Cash Flow. The consistent generation of Free Cash Flow is of growing importance in view of the significantly increased debt following the acquisition of Cypress (for an explanation of the development of Free Cash Flow during the 2021 fiscal year, see the chapter "Review of liquidity", [p. 106 f.](#)). Free Cash Flow is managed by Infineon at Group level only and not at segment level.

The main factors influencing Free Cash Flow are a positive earnings trend combined with effective management of inventories, trade accounts receivable and payable, and capital expenditures.

Free Cash Flow at Infineon is defined as follows:

Net cash provided by (used in) operating activities from continuing operations
+ Net cash provided by (used in) investing activities from continuing operations
+ Cash flows from the purchase and sale of financial investments
= Free Cash Flow

Return on Capital Employed (RoCE)

The performance indicator RoCE measures the return on capital and shows the correlation between profitability and the capital resources required to run the business (for the mathematical derivation and development of the RoCE in the 2021 fiscal year, see the chapter "Review of financial condition", [p. 105](#)). RoCE describes how efficiently a company uses its resources and serves as an instrument for value-based corporate management. It is also analyzed by Infineon at Group level only and not at segment level.

RoCE is defined as follows:

Operating profit, adjusted for:
Financial result excluding interest result
Share of profit (loss) of associates and joint ventures accounted for using the equity method
Income tax
= Operating profit from continuing operations after tax ①
Assets
- Cash and cash equivalents
- Financial investments
- Assets classified as held for sale
- Total current liabilities
+ Short-term financial debt and current maturities of long-term financial debt
+ Liabilities classified as held for sale
= Capital employed ②
RoCE ①/②

Selected supplementary performance indicators

The principal performance indicators are supplemented by the following additional performance indicators.

Growth and profitability indicators

Since the three principal performance indicators and especially Segment Result positively correlate with revenue growth, the latter is not used as a principal performance indicator in its own right but is covered by the three above-stated performance indicators indirectly.

In order to analyze the operating profitability in detail, the result and cost block components of the Segment Result are considered. These are the gross profit, research and development costs, selling, general and administrative expenses, as well as their relation to revenue.

These indicators are analyzed as well at Group level as at segment level (for the development of these indicators in the 2021 fiscal year, see the chapter “Review of results of operations”, [p. 99 ff.](#)).

Liquidity performance indicators

A rolling cash flow forecast helps ensure that Infineon has appropriate levels of liquidity at its disposal and an optimal capital structure. Liquidity is managed at Group level, not at segment level, using the following performance indicators:

- › **Gross cash position:** Cash and cash equivalents plus financial investments.
- › **Net cash position:** Gross cash position less short-term and long-term financial debt.
- › **Investments:** The total amount invested in property, plant and equipment and other intangible assets, including capitalized development costs.

For an analysis of changes in these performance indicators during the 2021 fiscal year, see the chapter “Review of liquidity”. [p. 106 f.](#)

Non-financial performance indicators

The non-financial performance indicators at Infineon include CO₂ emissions and indicators from the area of diversity.

Already at the 2020 Annual General Meeting, Infineon announced that it wanted to become CO₂ neutral by 2030. By 2025, Infineon would like to reduce its CO₂ emissions by 70 percent compared to the 2019 calendar year.

These goals are also reflected in the remuneration of the Management Board (see the chapter “Remuneration report”, [p. 132 ff.](#)).

Actual and target values for performance indicators

The chapter “Outlook”, [p. 109](#), contains a table comparing the actual values achieved in the 2021 fiscal year for principal and selected supplementary performance indicators with the values forecasted as well as the expectations for the 2022 fiscal year.

Sustainability at Infineon

Sustainability activities are described in the separate report “Sustainability at Infineon”.

In accordance with the stipulations of the German CSR Directive Implementation Act, Infineon Technologies AG is required to publish a non-financial report at both Company and Group level for the 2021 fiscal year. This report is published jointly for Infineon Technologies AG and the Group as a summarized separate non-financial report within the sustainability report. The information required by law is marked accordingly to distinguish it from the voluntary reporting according to GRI standards. The entire report “Sustainability at Infineon”, including the chapters of the Non-Financial Report, have been subjected to a limited assurance audit by KPMG AG Wirtschaftsprüfungsgesellschaft, Munich (Germany), and has been certified without restrictions. In addition, selected indicators were subjected to a reasonable assurance audit and certified without restrictions.

The separate report “Sustainability at Infineon”, including the summarized Non-Financial Report, is available on Infineon’s website at

www.infineon.com/csr_reporting.



Sustainability at Infineon

Supplementing the Annual Report 2021



The Infineon share

Basic information on shares

Share types	Ordinary registered shares in the form of shares or American Depositary Shares (ADS) with a notional value of €2 each (ADS: shares = 1:1)
Share capital	€2,611,842,274 (as of 30 September 2021), €2,611,842,274 (as of 30 September 2020)
Shares issued ¹	1,305,921,137 (as of 30 September 2021), 1,305,921,137 (as of 30 September 2020)
Own shares	4,545,602 shares (as of 30 September 2021), 5,251,391 shares (as of 30 September 2020)
ISIN	DE0006231004
WKN	623100
Ticker symbol	IFX (share), IFNNY (ADS)
Bloomberg Nasdaq IR Insight	IFX GY (Xetra trading system), IFNNY US IFX-XE, IFNNY-PK
Listings	Shares: Frankfurt Stock Exchange (FSE)
Market capitalization ²	€46,231 million (as of 30 September 2021)
Daily average shares traded on Xetra	4,884,416 (in the 2021 fiscal year)
Trading in the USA	ADS, over-the-counter trading on the OTC market (OTCQX)
Market capitalization ²	US\$53,539 million (as of 30 September 2021)
Daily average ADS traded	180,128 (in the 2021 fiscal year)
Index membership (selected)	DAX 40 TecDAX EURO STOXX 50 Dow Jones STOXX Europe 600 Dow Jones Euro STOXX TMI Technology Hardware & Equipment Dow Jones Germany Titans 30 MSCI Germany S&P-Europe-350 Dow Jones Sustainability World Index

¹ The number of shares issued includes own shares.

² Own shares were not taken into consideration for calculation of market capitalization.

A full overview of other major indices in which the Infineon share is represented can be found on Infineon's website at

www.infineon.com/cms/en/about-infineon/investor/infineon-share/#5.

Basic information on bonds and other financing instruments

1.500% Bond from 10 March 2015	€500 million	due on 10 March 2022, ISIN: XS1191116174
0.750% Bond from 24 June 2020	€750 million	due on 24 June 2023, ISIN: XS2194282948
1.125% Bond from 24 June 2020	€750 million	due on 24 June 2026, ISIN: XS2194283672
1.625% Bond from 24 June 2020	€750 million	due on 24 June 2029, ISIN: XS2194283839
2.000% Bond from 24 June 2020	€650 million	due on 24 June 2032, ISIN: XS2194192527
2.875% Hybrid Bond from 1 October 2019	€600 million	first reset date 1 January 2025, ISIN: XS2056730323
3.625% Hybrid Bond from 1 October 2019	€600 million	first reset date 1 January 2028, ISIN: XS2056730679
US Private Placement from 5 April 2016	US\$350 million	due on 5 April 2024
US Private Placement from 5 April 2016	US\$350 million	due on 5 April 2026
US Private Placement from 5 April 2016	US\$235 million	due on 5 April 2028
US Private Placement from 16 June 2021	US\$350 million	due on 16 June 2027
US Private Placement from 16 June 2021	US\$350 million	due on 16 June 2029
US Private Placement from 16 June 2021	US\$350 million	due on 16 June 2031
US Private Placement from 16 June 2021	US\$250 million	due on 16 June 2033
Term loan from 3 June 2019	US\$1,110 million	due on 3 June 2024
4.500% Convertible Bond from 23 June 2016	US\$216 million	due on 15 January 2022, ISIN: US232806AM17
Rating of S&P Global Ratings		since 11 February 2021: "BBB-" Outlook: "positive"

Share price development

The Infineon share finished the 2021 fiscal year at a closing price of €35.53, up 47 percent on the €24.12 recorded one year earlier.

The coronavirus pandemic caused a sharp decline in share prices on global stock markets at the beginning of the 2020 calendar year. The share price then began to recover in mid-March 2020 and continued to increase during the 2021 fiscal year. Thus the share price rose more or less steadily between October 2020 and September 2021.

The low for the 2021 fiscal year was recorded right away at the end of October 2020. At €23.69, the share price at that stage was only marginally lower than the €24.12 quoted at the beginning of the fiscal year. The high for the fiscal year of €37.92 was recorded in mid-September 2021, shortly before the end of the fiscal year. With a price increase of 47 percent, the Infineon share significantly outperformed the DAX, which improved by 20 percent over the same period. The US benchmark indices were also unable to match Infineon’s performance. The Dow Jones US Semiconductor Index rose by 39 percent over the twelve-month period and the Philadelphia Semiconductor Index (SOX) was up by 45 percent.

C35 Development of the Infineon Technologies AG share compared to Germany’s DAX Index, the Philadelphia Semiconductor Index (SOX) and the Dow Jones US Semiconductor Index for the 2021 fiscal year (daily closing prices)



Driven by the share’s strong performance, Infineon’s market capitalization grew from €31,366 million at 30 September 2020 to €46,231 million at the end of the 2021 fiscal year.

Trading volumes and stock indices

Measured in units, the average daily trading volume of the Infineon share on Xetra during the 2021 fiscal year was 4.9 million shares. Compared with the previous year’s figure of 7.7 million shares, the figure represents a decrease of 36 percent. On the other hand, due to the significant rise in the Infineon share price, the average daily trading volume measured in euros increased by 11 percent from €143.5 million in the previous year to €158.0 million in the 2021 fiscal year.

In the USA, the Infineon share is traded in the form of American Depositary Shares (“ADS”) on the OTCQX International over-the-counter market under the ticker symbol “IFNNY”. About 180,000 ADS were traded daily on this market in the 2021 fiscal year (previous year: approximately 235,000 daily). The number of ADS outstanding decreased from 39.2 million as of 30 September 2020 to 33.0 million at the end of the 2021 fiscal year.

Infineon has been listed in the EURO STOXX 50 index since 22 March 2021. On 20 September 2021, the size of the German stock exchange index (DAX) was increased from 30 to 40 stocks. At the same time, the rules determining the DAX ranking list were also changed. With effect from September 2021, only market capitalization is taken into account for these purposes, whereas trading volume no longer plays a role. Measured by market capitalization, Infineon ranked 11th in September 2021, moving up two places year-on-year. As in the previous year, Infineon achieved the 3rd position in the TecDAX at the end of the 2021 fiscal year in terms of market capitalization.

Shareholder structure

As of 30 September 2021, similar to the previous year, four shareholders each held more than three percent of the Infineon shares issued. The share capital held by retail shareholders amounted to 8.54 percent at the end of the 2021 fiscal year, compared with 8.82 percent one year earlier.

C36 Shareholder structure as of the end of the 2021 fiscal year

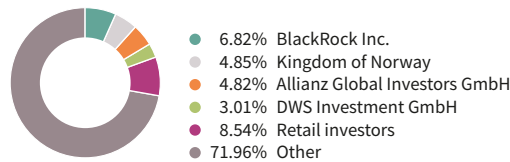

Dividend

Our dividend policy is aimed at letting shareholders adequately participate in Infineon's economic development and, in general, at paying out at least an unchanged dividend even in the event of stagnating or declining earnings. However, due to the negative economic impact of the coronavirus pandemic, the risks that existed at the time of the payout, and in order to maintain sufficient financial flexibility, a dividend of €0.22 was paid for the 2020 fiscal year, i.e., €0.05 lower than the amount distributed for the 2019 fiscal year. Due to Infineon's good economic performance in the 2022 fiscal year and the positive outlook for the current fiscal year, the dividend is now to be increased again by €0.05. Accordingly, a proposal is planned to be put forward at the Annual General Meeting in February 2022 to distribute a dividend of €0.27 per share for the 2021 fiscal year. The number of shares issued totaled 1,305,921,137 as of 30 September 2021. The figure includes 4,545,602 shares owned by the Company that are not entitled to a dividend. The total dividend amount would therefore increase to €351 million, compared with €286 million one year earlier.

Interested parties may participate in telephone conferences via a webcast broadcast in the Investor Relations section of the Infineon website.

www.infineon.com/investor

Retail investors can contact us by email (investor.relations@infineon.com) and by telephone (+49 89 234-26655).

Group performance

Review of results of operations

The consolidated statement of profit or loss

€ in millions, except earnings per share	2021	2020
Revenue	11,060	8,567
Gross profit	4,260	2,776
Research and development expenses	(1,448)	(1,113)
Selling, general and administrative expenses	(1,354)	(1,042)
Other operating income and expenses, net	12	(40)
Operating profit	1,470	581
Net financial result (financial income and expenses, net)	(160)	(148)
Share of profit (loss) of associates and joint ventures accounted for using the equity method	9	(9)
Income tax	(144)	(52)
Profit (loss) from continuing operations	1,175	372
Profit (loss) from discontinued operations, net of income taxes	(6)	(4)
Profit (loss) for the period	1,169	368
Basic earnings per share (in euro)	0.87	0.26
Diluted earnings per share (in euro)	0.87	0.26
Adjusted earnings per share (in euro) – diluted	1.20	0.64

Strong business performance and first full-year inclusion of Cypress drive revenue growth

Revenue grew by €2,493 million or 29 percent to €11,060 million in the 2021 fiscal year (2020: €8,567 million). The increase was mainly attributable to favorable volume and pricing factors in light of continued high demand for semiconductors in conjunction

with the related expansion of manufacturing capacities. On the other hand, Cypress contributed to Group revenue for a full fiscal year for the first time, whereas in the previous fiscal year Cypress' revenue was only included for the period from April to September. Pandemic-related constraints, for example, on manufacturing capacity in Melaka (Malaysia) and on contract manufacturers, and the aftermath of the winter storm in Austin (Texas, USA) had an offsetting effect.

Automotive remained Infineon's highest-selling segment. Based on segment revenue of €4,841 million (2020: €3,521 million), it contributed 44 percent of Infineon's total revenue. The 37 percent year-on-year increase in revenue was primarily due to the recovery in the automotive sector and the twelve-month revenue contribution from Cypress.

Revenue generated by the Industrial Power Control segment totaled €1,542 million and was therefore 10 percent above the previous year's figure of €1,406 million. The segment contributed 14 percent to Group revenue.

The Power & Sensor Systems segment recorded revenue of €3,268 million (2020: €2,650 million), corresponding to a 23 percent growth rate and a 29 percent contribution to Group revenue. The main reason for the sharp rise was the ever-increasing demand for semiconductors in a wide range of applications. Growth was also driven by the first-time consolidation of Cypress' USB components business for a full fiscal year.

The Connected Secure Systems segment recorded revenue of €1,397 million in the 2021 fiscal year (2020: €974 million), with the twelve-month Cypress revenue figure making a substantial contribution to the year-on-year growth of 43 percent besides an improved product mix. The segment contributed 13 percent to Group revenue.

Further details on the performance of the segments can be found in the chapter "The segments". [p. 58 ff.](#)

C37 Revenue by segment

€ in millions

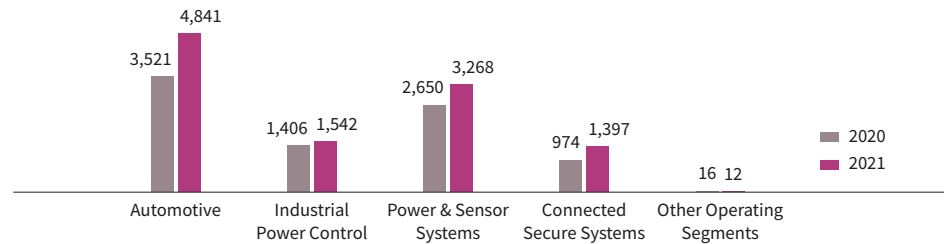

C38 Revenue by segment in the 2021 fiscal year

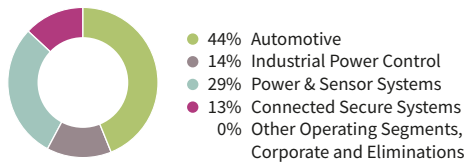

Negative impact of currency developments on revenue growth

The majority of **revenue** was generated in **foreign currencies** in the 2021 fiscal year, with revenue denominated in US dollars accounting for the largest share. The average euro/US dollar exchange rate changed from around 1.12 in the previous fiscal year to 1.19 in the 2021 fiscal year, giving rise to negative currency effects.

Regional distribution of revenue largely unchanged year-on-year

€ in millions, except percentages

	2021		2020	
Europe, Middle East, Africa	2,773	25%	2,322	27%
therein: Germany	1,278	12%	1,056	12%
Asia-Pacific (excluding Japan, Greater China)	1,744	16%	1,291	15%
Greater China ¹	4,195	38%	3,174	37%
therein: Mainland China, Hong Kong	3,178	29%	2,472	29%
Japan	1,094	10%	765	9%
Americas	1,254	11%	1,015	12%
therein: USA	1,027	9%	845	10%
Total	11,060	100%	8,567	100%

¹ Greater China comprises Mainland China, Hong Kong and Taiwan.

The distribution of revenue by region remained more or less unchanged compared to the 2020 fiscal year. As in the previous year, Greater China was the largest region in revenue terms, accounting for 38 percent of total revenue generated in the 2021 fiscal year worldwide, followed by the Europe, Middle East, Africa region with 25 percent.

China (comprising Mainland China and Hong Kong) accounted for €3,178 million, or 29 percent of Infineon’s global revenue, and therefore had the largest share at the individual country level, followed by Germany with €1,278 million or 12 percent.

Gross margin significantly improved

Gross profit (revenue less cost of goods sold) amounted to €4,260 million, 53 percent up on the €2,776 million recorded one year earlier. The **gross margin** improved accordingly from 32.4 percent in the 2020 fiscal year to 38.5 percent in the 2021 fiscal year.

At €6,800 million, the **cost of goods sold** during the fiscal year under report was €1,009 million or 17 percent higher than the previous year's figure of €5,791 million. The increase was therefore less pronounced than that of revenue. Factors contributing to this strong earnings performance included lower idle costs compared to one year earlier and favorable revenue-related pricing effects. Conversely, the pandemic-related restrictions on manufacturing in Melaka (Malaysia) worked in the opposite direction. Cost of goods sold also include expenses in connection with the shutdown of the fabrication plant in Austin (Texas, USA), which was ordered by the relevant authorities following a severe winter storm that resulted in prolonged power outages in the region.

Cost of goods sold also includes expenses arising in connection with the acquisition of Cypress and, to a lesser extent, with the acquisition of International Rectifier (in the 2015 fiscal year) totaling €295 million (2020: €288 million). This amount comprised the income statement impact of amortization and depreciation of fair value adjustments recognized in conjunction with the respective purchase price allocations as well as €17 million (2020: €28 million) of other acquisition-related expenses. The figure reported for the previous fiscal year also included expenses arising on the consumption of inventories measured at their fair value in conjunction with the acquisition of Cypress.

€ in millions, except percentages	2021	2020
Cost of goods sold	6,800	5,791
Change year-on-year	17%	15%
Percentage of revenue	61.5%	67.6%
Gross profit	4,260	2,776
Percentage of revenue (gross margin)	38.5%	32.4%

Operating expenses stable as percentage of revenue

Operating expenses (research and development expenses, selling, general and administrative expenses) increased by €647 million to €2,802 million year-on-year (2020: €2,155 million), corresponding to 25.3 percent of revenue (2020: 25.2 percent).

Research and development expenses

€ in millions, except percentages	2021	2020
Research and development expenses, gross	1,770	1,379
Minus:		
Grants received	(123)	(108)
Capitalized development costs	(199)	(158)
Research and development expenses	1,448	1,113
Change year-on-year	30%	18%
Percentage of revenue	13.1%	13.0%

Research and development expenses amounted to €1,448 million in the 2021 fiscal year, an increase of €335 million or 30 percent compared to the previous year's figure of €1,113 million. The principal reasons for the higher figure were the inclusion of Cypress for the full twelve-month period compared to the previous year, a further increase in research and development activities, and the recruitment of additional staff. In this context, the number of people employed in research and development functions rose by 12 percent to 10,372 employees (30 September 2020: 9,262 employees). Moreover, acquisition-related expenses amounting to €15 million were included in research and development expenses (2020: €18 million).

As a percentage of revenue, research and development expenses amounted to 13.1 percent in the 2021 fiscal year, roughly at the same level as one year earlier (13.0 percent).

The main research and development activities undertaken during the 2021 fiscal year are described in more detail in the chapter "Research and development". [□ p. 81 ff.](#)

Selling, general and administrative expenses

€ in millions, except percentages	2021	2020
Selling, general and administrative expenses	1,354	1,042
Change year-on-year	30%	20%
Percentage of revenue	12.2%	12.2%

Selling, general and administrative expenses increased by €312 million or 30 percent to €1,354 million year-on-year. The figure also includes the twelve-month contribution from Cypress, higher earnings effects from purchase price allocations and acquisition-related expenses for the acquisition of Cypress and International Rectifier totaling €219 million (2020: €161 million). As a percentage of revenue, selling, general and administrative expenses amounted to 12.2 percent in the 2021 fiscal year and were therefore at the same level as one year earlier (2020: 12.2 percent).

Increase in net amount of other operating income and expenses

The **net amount of other operating income and expenses** improved to a positive amount of €12 million (2020: negative €40 million). Other operating income fell by €12 million, whereby it should be noted that the previous year's figure included one-off income of €20 million arising on the sale of non-current assets. Other operating expenses went down by €64 million, mainly due to the €31 million decrease in acquisition-related expenses to €14 million (2020: €45 million).

Slight deterioration in financial result

The **financial result** deteriorated from a negative amount of €148 million in the previous year to negative €160 million. Of this, negative €150 million relates to net interest result. Further details are provided in note 3 to the Consolidated Financial Statements. [p. 172](#)

Effective tax rate down to 10.9 percent

The **income tax expense** for the 2021 fiscal year increased to €144 million (2020: €52 million), mainly due to the higher level of pre-tax income. Based on profit from continuing operations before income taxes of €1,319 million (2020: €424 million), the effective tax rate for the reporting period was 10.9 percent (2020: 12.3 percent).

As in the previous fiscal year, the income tax expense for the 2021 fiscal year was affected by foreign tax rates, non-deductible expenses, tax-exempt income, tax credits and changes in valuation allowances on deferred tax assets.

Further details regarding income tax expense are provided in note 5 to the Consolidated Financial Statements. [p. 173 ff.](#)

Profit for the period and earnings per share up on previous year

After deducting income taxes and the loss from discontinued operations, Infineon recorded profit for the period of €1,169 million for the 2021 fiscal year (2020: €368 million).

The higher **profit for the period** resulted in a corresponding increase in **earnings per share**.

Both basic and diluted earnings per share amounted to €0.87 (2020: €0.26) for the 2021 fiscal year.

The calculation of earnings per share in accordance with IFRS is presented in detail in note 7 to the Consolidated Financial Statements. [p. 176 f.](#)

Increase in adjusted earnings per share

Earnings per share in accordance with IFRS are influenced by amounts relating to purchase price allocations for acquisitions (in particular Cypress and International Rectifier), by one-time expenses recorded within the financial result in conjunction with the acquisition of Cypress and other exceptional items. To enable better

comparability of operating performance over time, Infineon computes the **adjusted earnings per share (diluted)**. Adjusted profit (loss) for the period and adjusted earnings per share (diluted) should not be seen as a replacement or superior performance indicator, but rather as additional information to the profit (loss) for the period and earnings per share (diluted) determined in accordance with IFRS.

Adjusted earnings per share (diluted) increased from €0.64 to €1.20 per share and were calculated as follows:

€ in millions (unless otherwise stated)	2021	2020
Profit (loss) from continuing operations – diluted	1,175	372
Compensation of hybrid capital investors ¹	(26)	(35)
Profit (loss) from continuing operations, attributable to shareholders of Infineon Technologies AG – diluted	1,149	337
Plus/minus:		
Impairments (reversal of impairments) (in particular on goodwill)	(1)	(11)
Impact on earnings of restructuring and closures, net	–	20
Share-based payment	27	14
Acquisition-related depreciation/amortization and other expenses	544	540
Losses (gains) on sales of businesses, or interests in subsidiaries, net	1	(1)
Other income and expense, net	31	27
Acquisition-related expenses within financial result	7	49
Tax effects on adjustments	(131)	(126)
Revaluation of deferred tax assets resulting from the annually updated earnings forecast	(64)	(35)
Adjusted profit (loss) for the period from continuing operations attributable to shareholders of Infineon Technologies AG – diluted	1,563	814
Weighted-average number of shares outstanding (in millions) – diluted	1,304	1,266
Adjusted earnings per share (in euro) – diluted²	1.20	0.64

¹ Including the cumulative tax effect.

² The calculation of the adjusted earnings per share is based on unrounded figures.

Review of financial condition

€ in millions, except percentages	30 September 2021	30 September 2020	Change year-on-year
Current assets	8,252	7,179	15%
Non-current assets	15,082	14,820	2%
Total assets	23,334	21,999	6%
Current liabilities	4,443	3,450	29%
Non-current liabilities	7,490	8,330	(10%)
Total liabilities	11,933	11,780	1%
Total equity	11,401	10,219	12%
Statement of Financial Position ratios:			
Return on assets ¹	5.0%	1.7%	
Equity ratio ²	48.9%	46.5%	
Return on equity ³	10.3%	3.6%	
Debt-to-equity ratio ⁴	57.8%	68.8%	
Inventory intensity ⁵	9.3%	9.3%	
RoCE ⁶	8.4%	3.0%	

¹ Return on assets = Profit (loss) for the period/Total assets

² Equity ratio = Total equity/Total assets

³ Return on equity = Profit (loss) for the period/Total equity

⁴ Debt-to-equity ratio = (Long-term and short-term financial debt)/Total equity

⁵ Inventory intensity = Inventories (net)/Total assets

⁶ Calculation see following section about RoCE in this chapter, [p. 104 f.](#)

Significant increase in current assets mostly due to gross cash position

Current assets went up by €1,073 million to stand at €8,252 million as of 30 September 2021, compared to €7,179 million one year earlier. The increase resulted mainly from the gross cash position, which improved by €695 million to €3,922 million (30 September 2020: €3,227 million). For comments on the change of the gross cash position,

see the chapter “Review of liquidity”, [p. 107](#) Trade receivables also increased by €287 million due to the significant rise in revenue. Inventories went up by €129 million to keep pace with continued high demand at this especially unfinished goods.

Slight increase in non-current assets mainly due to investments in property, plant and equipment

Non-current assets increased by €262 million to stand at €15,082 million at the end of the reporting period (30 September 2020: €14,820 million). The increase was primarily due to the higher level of property, plant and equipment, which went up by €333 million to €4,443 million compared to €4,110 million as of 30 September 2020, with additions exceeding depreciation. Investments related primarily to the manufacturing sites in Villach (Austria), Dresden and Regensburg (both Germany), Kulim and Melaka (both Malaysia), Singapore and Cegléd (Hungary). Goodwill increased by €65 million to €5,962 million due to currency factors. Besides this, deferred tax assets increased by €68 million and right-of-use assets by €50 million. By contrast, other intangible assets decreased by €272 million to €3,349 million, mainly due to the amortization of technologies acquired in the course of the acquisition of Cypress.

Liabilities slightly higher

Total liabilities stood at €11,933 million as of 30 September 2021 and were therefore €153 million higher than one year earlier (30 September 2020: €11,780 million). Trade payables increased by €409 million from €1,160 million to stand at €1,569 million at the end of the reporting period due to high utilization of production, on the one hand, and even more to higher investments. Provisions went up by €385 million to €1,134 million, as the recognition of the performance-related employee remuneration for the reporting period exceeded the payments made for the previous year.

At the same time, gross financial debt decreased by €448 million to €6,585 million (30 September 2020: €7,033 million), partly due to the early repayment of €310 million of financial debt raised in connection with the acquisition of Cypress. Information on the composition and maturities of gross financial debt is provided in note 15 to the Consolidated Financial Statements. [p. 184 f.](#)

C39 Financial debt by currencies

€ in millions

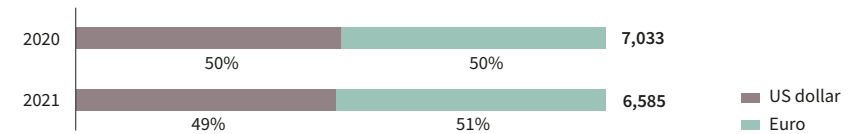

Pensions and similar commitments decreased by €122 million, primarily due to an actuarial gain of €128 million after tax arising on the measurement of net pension obligations and as a consequence of interest rate and credit spread developments on financial markets during the fiscal year just ended (see note 18 to the Consolidated Financial Statements, [p. 187 ff.](#)).

Shareholders' equity up mainly due to profit for the period

Equity increased by €1,182 million to stand at €11,401 million at the end of the reporting period (30 September 2020: €10,219 million), mostly due to the profit for the period for the 2021 fiscal year amounting to €1,169 million. Actuarial gains arising on the measurement of pensions and similar commitments totaling €128 million after tax recognized through other comprehensive income also had a positive impact on equity. Positive currency effects amounting to €90 million, which were recognized in other reserves, also contributed to the higher figure. These increases in equity were offset mainly by the dividend of €286 million paid out for the 2020 fiscal year.

The equity ratio as of 30 September 2021, based on total assets amounting to €23,334 million, was 48.9 percent (30 September 2020: 46.5 percent, based on total assets amounting to €21,999 million).

RoCE significantly improved due to higher operating profit

In the 2021 fiscal year, operating profit from continuing operations after tax increased sharply by €852 million to €1,325 million (2020: €473 million).

The higher level of operating profit was mainly due to the significant revenue growth in connection with the resulting good utilization (see the chapter “Review of results of operations”, [p. 99 f.](#)).

At €15,793 million, however, capital employed was almost identical to one year earlier (30 September 2020: €15,827 million).

As a result, the **Return on Capital Employed (RoCE)** rose sharply from 3.0 percent to 8.4 percent.

RoCE for the 2021 and 2020 fiscal years is calculated as follows:

€ in millions, except percentage	2021	2020
Operating profit	1,470	581
Plus/minus:		
Financial result excluding interest result ¹	(10)	(47)
Share of profit (loss) of associates and joint ventures accounted for using the equity method	9	(9)
Income tax	(144)	(52)
Operating profit from continuing operations after tax ①	1,325	473
Assets	23,334	21,999
Plus/minus:		
Cash and cash equivalents	(1,749)	(1,851)
Financial investments	(2,173)	(1,376)
Assets classified as held for sale	(9)	-
Total current liabilities	(4,443)	(3,450)
Short-term financial debt and current maturities of long-term financial debt	833	505
Capital employed ②	15,793	15,827
RoCE ①/②	8.4%	3.0%

¹ The financial result for the 2021 and 2020 fiscal year amounted to negative €160 million and negative €148 million, respectively, and included negative €150 million and negative €101 million, respectively, of net interest result.

Review of liquidity

Cash flow

€ in millions	2021	2020
Net cash provided by operating activities from continuing operations	3,063	1,817
Net cash used in investing activities from continuing operations	(2,284)	(7,172)
Net cash used in (provided by) financing activities from continuing operations	(885)	6,274
Net change in cash and cash equivalents from discontinued operations	2	(6)
Cash-relevant change in cash and cash equivalents	(104)	913
Effect of foreign exchange rate changes on cash and cash equivalents	2	(83)
Change in cash and cash equivalents	(102)	830

Sharp increase in net cash provided by operating activities from continuing operations

Net cash provided by operating activities from continuing operations in the 2021 fiscal year amounted to €3,063 million, an increase of €1,246 million compared to the previous fiscal year's figure of €1,817 million. The main reason for the higher figure was the improvement of €1,197 million in profit from continuing operations before depreciation, amortization, impairment losses, interest and tax, which rose in total to €2,994 million. The increase in trade payables and provisions exceeded the higher amount tied up in trade receivables and inventories, contributing a net amount of €379 million to the improvement in cash provided by operating activities from continuing operations. Cash outflows for income taxes and interest had an offsetting effect totaling €325 million.

In the 2020 fiscal year, **net cash provided by operating activities from continuing operations** totaled €1,817 million. Taking profit from continuing operations before depreciation, amortization, impairment losses, interest and taxes amounting to €1,797 million as the starting point, changes in inventories, trade receivables and trade payables totaling €99 million were the main items with a positive impact on net cash provided by operating activities from continuing operations. Net cash outflows

for interest and taxes totaled €180 million. Changes in provisions, other non-cash income/expense and gains on the disposal of property, plant and equipment accounted for the remainder.

Net cash used in investing activities from continuing operations dominated by investments in property, plant and equipment

Net cash used in investing activities from continuing operations totaled €2,284 million in the 2021 fiscal year, including €1,268 million invested in property, plant and equipment and €229 million in intangible and other assets (see the chapter “Review of financial condition”, [p. 104](#)). Furthermore, a net cash outflow of €795 million arose in conjunction with the purchase and sale of financial investments deemed to be part of the gross cash position and which are therefore not included in Free Cash Flow (see below the chapter “Free Cash Flow”).

In the 2020 fiscal year, net cash used in investing activities from continuing operations totaled €7,172 million, including net cash outflows of €7,433 million for the acquisition of Cypress. The net amount arising on purchases and sales of financial investments resulted in a net cash inflow of €1,372 million. In addition, €915 million was invested in property, plant and equipment and €184 million in intangible and other assets.

Repayment of financial debt and payment of dividend result in net cash used in financing activities from continuing operations

Net cash used in financing activities from continuing operations totaled €885 million in the 2021 fiscal year. This included net outflows of €486 million for the repayment of financial debt (see the chapter “Review of financial condition”, [p. 104](#), and note 15 to the Consolidated Financial Statements, [p. 184 f.](#)). The payment of the dividend for the 2020 fiscal year amounting to €286 million, payments for leasing liabilities amounting to €76 million and cash outflows to hybrid capital investors amounting to €39 million also had the effect of reducing cash and cash equivalents.

In the 2020 fiscal year, net cash provided by financing activities from continuing operations totaled €6,274 million. This included net cash inflows of €4,443 million relating to new financial debt, net proceeds of €1,040 million from the share capital increase executed in May 2020 and net proceeds of €1,184 million from the issuance of a hybrid bond in two tranches in October 2019. An offsetting effect resulted from the payment of the dividend for the 2019 fiscal year amounting to €336 million and payments to hybrid capital investors amounting to €20 million.

Free Cash Flow

Infineon reports the Free Cash Flow figure, defined as net cash provided by and/or used in operating activities and net cash provided by and/or used in investing activities, both from continuing operations, after adjusting for cash flows related to the purchase and sale of financial investments. Free Cash Flow serves as an additional performance indicator, since Infineon holds part of its liquidity in the form of financial investments. This does not mean that the Free Cash Flow calculated in this way is available to cover other disbursements, since dividends, debt-servicing obligations and other fixed disbursements are not deducted. Free Cash Flow should not be seen as a replacement or superior performance indicator, but rather as an additional useful item of information over and above the disclosure of the cash flow reported in the Consolidated Statement of Cash Flows, and as a supplementary disclosure to other liquidity performance indicators and other performance indicators derived from the IFRS figures. Free Cash Flow only includes amounts from continuing operations and is derived as follows from the Consolidated Statement of Cash Flows:

€ in millions	2021	2020
Net cash provided by operating activities from continuing operations	3,063	1,817
Net cash used in investing activities from continuing operations	(2,284)	(7,172)
Purchases of (proceeds from sales of) financial investments, net	795	(1,372)
Free Cash Flow	1,574	(6,727)

Significant increase in Free Cash Flow

Free Cash Flow in the 2021 fiscal year amounted to €1,574 million, with net cash provided by operating activities from continuing operations amounting to €3,063 million easily exceeding investments in property, plant and equipment and other intangible and other assets totaling €1,497 million.

Free Cash Flow in the previous fiscal year was a negative amount of €6,727 million, influenced primarily by the net payment (i.e., net of cash and cash equivalents acquired) amounting to €7,433 million used to acquire Cypress as well as by other cash outflows in connection with the acquisition totaling €205 million. Excluding cash used in conjunction with the acquisition of Cypress, Free Cash Flow in the 2020 fiscal year would have been a positive amount of €911 million. Investments in property, plant and equipment as well as in intangible assets and other assets resulted in cash outflows totaling €1,099 million.

Gross cash position and net cash position

The following table reconciles the gross cash position and the net cash position (i.e., after deduction of financial debt). Since some liquid funds are held in the form of financial investments, which, for IFRS purposes, are not considered to be cash and cash equivalents, Infineon reports on its gross and net cash positions in order to provide investors with a better understanding of its overall liquidity situation. The gross and net cash positions are determined as follows from the Consolidated Statement of Financial Position:

€ in millions	30 September 2021	30 September 2020
Cash and cash equivalents	1,749	1,851
Financial investments	2,173	1,376
Gross cash position	3,922	3,227
Minus:		
Short-term financial debt and current portion of long-term financial debt	833	505
Long-term financial debt	5,752	6,528
Gross financial debt	6,585	7,033
Net cash position	(2,663)	(3,806)

The gross cash position as of 30 September 2021 increased by €695 million to €3,922 million, with most of the increase reflecting the high Free Cash Flow amounting to €1,574 million. An offsetting effect resulted from net repayments of financial debt amounting to €486 million, the dividend payment for the 2020 fiscal year amounting to €286 million and payments for leasing liabilities amounting to €76 million.

The net cash position, which is defined as the gross cash position less short-term and long-term financial debt, improved accordingly by €1,143 million to stand at a negative amount of €2,663 million at the end of the reporting period (30 September 2020: negative €3,806 million).

Taking into account the financial resources available to Infineon – including internal liquidity on hand, net cash that will be generated, and currently available credit facilities amounting to €69 million (2020: €69 million, see note 15 to the Consolidated Financial Statements, [p. 185](#)) – Infineon assumes that it will be able to cover those capital requirements for the 2022 fiscal year that are currently expected. These include the repayment of financial debt. Forecasted capital requirements also include other financial obligations, such as orders already placed for initiated or planned investments in property, plant and equipment (see note 22 to the Consolidated Financial Statements, [p. 197](#)). Investments planned for the 2022 fiscal year are discussed in the chapter “Outlook”. [p. 109 ff.](#)

Infineon is party to two financing agreements that contain a number of standard covenants, including a debt coverage ratio that provides for a certain relationship between the size of debt (adjusted) and earnings (adjusted) (see note 20 to the Consolidated Financial Statements, [p. 195](#)).

Principles and structure of Infineon’s treasury

The Infineon treasury’s stated objective is to ensure financial flexibility based on a solid capital structure. Its primary goal is to ensure that sufficient cash funds are available to finance operating activities and planned investments throughout all phases of the business cycle. We aim to achieve a gross liquidity level of €1 billion, plus at least 10 percent of revenue.

As a general rule, debt should only constitute a modest proportion of the financing mix to ensure that sufficient headroom is available at all times. The key objective is to maintain an investment grade rating. Infineon is currently rated by S&P Global Ratings as “BBB–” with positive outlook. The originally medium-term objective of Infineon to reduce its debt level to or below the maximum target value of twice the gross financial debt to EBITDA after the closing of the Cypress transaction is expected to be achieved already in the 2022 fiscal year. For further information on the nature, maturity, currency and interest rate structure of gross financial debt, see note 15 to the Consolidated Financial Statements, [p. 184 f.](#)

The treasury principles referred to are in place regarding all issues relating to liquidity and financing, such as banking policies and strategies, execution of financing agreements, liquidity and investment management worldwide, currency and interest rate risk management and the handling of external and intragroup cash flows.

In accordance with our treasury principles, we follow a centralized approach in which the Group Finance & Treasury department is responsible for all major tasks and processes worldwide relating to financing and treasury matters.

In the context of centralized liquidity management and where permitted by law and economically feasible, cash pooling structures are in place in order to ensure the best possible allocation of liquidity within the Group and reduce external financing requirements. Liquidity accumulated at Group level is invested centrally by the Group Finance & Treasury department based on a conservative approach to investments, in which preservation of capital is prioritized over return maximization. The Group Finance & Treasury department is also responsible for managing currency and interest rate risks and for the execution of the commodity price hedging. We employ the

following derivative financial instruments in our continuous operations for hedging purposes: forward foreign currency contracts to reduce the impact of exchange rate exposures (to the extent foreign currency cash flows are not offset within the Group) and commodity swaps to reduce price risks for expected purchases of gold. Derivative financial instruments are not used for trading or speculation purposes. Further information regarding derivative financial instruments and the management of financial risks is provided in note 26, [p. 203 ff.](#), and note 27 to the Consolidated Financial Statements, [p. 211 ff.](#)

Furthermore, to the extent permitted by law, all financing activities and credit lines worldwide are arranged, structured and managed either directly or indirectly by the Group Finance & Treasury department in accordance with stipulated treasury principles.

A Treasury Committee is in place to deliberate on current financial market developments and their potential impact on Infineon and coordinate key liquidity, hedging, and financing issues. The Committee, which meets on a quarterly basis, comprises the CFO and representatives from the Finance & Treasury, Accounting and Financial Reporting, Controlling, and Tax departments.

Following the acquisition of Cypress, the financing and treasury activities of Cypress are being successively integrated into Infineon’s core structures. Significant further progress was made in this respect during the 2021 fiscal year.

Report on outlook, risk and opportunity

Outlook

Actual and target values for performance indicators

The following table and subsequent comments compare the actual and forecast values of Infineon's key performance indicators for the 2021 fiscal year and show the outlook for the 2022 fiscal year.

€ in millions, except percentages	Actuals FY 2020	Outlook for FY 2021 ¹	Actuals FY 2021	Outlook for FY 2022
Principal performance indicators				
Segment Result Margin	13.7%	Above 18% (at a revenue level of €11 billion)	18.7%	Around 21% (at a revenue level of €12.7 billion)
Free Cash Flow from continuing operations	(6,727)	Around €1.5 billion	1,574	Around €1 billion
RoCE	3.0%	Around 7.5%	8.4%	Minimum 10%
Selected supplementary performance indicators				
Revenue respectively change in revenue com- pared to previous year	8,567	Revenue increase to around €11 billion	11,060	Revenue increase to around €12.7 billion plus or minus €500 million
Investments	1,099	Around €1.6 billion	1,497	Around €2.4 billion
Gross cash position	3,227	In the range of €2.9 billion to €3.6 billion and therefore within the target range of €1 billion plus at least 10% of revenue	3,922	Around €4 billion and therefore within the target range of €1 billion plus at least 10% of revenue

¹ The forecast presented here corresponds to the forecast last finalized in the third quarter of the 2021 fiscal year.

Comparison of original outlook and actual figures for the 2021 fiscal year

Revenue for the 2021 fiscal year was originally forecast in November 2020 at an amount of €10.5 billion, plus or minus 5 percent. In light of the positive business performance, the outlook was raised at a number of points over the following quarters to an expected revenue of around €11 billion. The actual amount of revenue generated in the 2021 fiscal year was €11,060 million. This figure was in line with the most recent outlook dated 3 August 2021 and slightly above the range stated in the original outlook from November 2020.

In conjunction with the adjustments to the revenue forecast, the expected Segment Result Margin was also adjusted in each quarter. Originally, a Segment Result Margin of 16.5 percent was forecast for the 2021 fiscal year. After initially raising the outlook to 17.5 percent with the publication of first-quarter figures of the 2021 fiscal year and subsequently to around 18 percent with the publication of second-quarter figures, the most recent outlook, published in August 2021, forecast the Segment Result Margin at above 18 percent. In the final analysis, this outlook was achieved with an actual Segment Result Margin of 18.7 percent.

Free Cash Flow was originally expected to exceed €700 million. Here, too, the outlook was raised in stages. Initially, the outlook was raised in February 2021 and predicted to exceed €800 million. In August 2021, Free Cash Flow was anticipated to come in at around €1.5 billion. Free Cash Flow generated in the 2021 fiscal year ultimately amounted to €1,574 million and was therefore in line with the forecast.

A Return on Capital Employed (RoCE) of about 6 percent was originally forecast in November 2020 for the 2021 fiscal year. With the publication of the figures for the first half of the 2021 fiscal year, this forecast was raised to 7.5 percent. The actual RoCE for the 2021 fiscal year came in at 8.4 percent, a significant improvement on that reported for the 2020 fiscal year, mainly due to the good operating profit from continuing operations.

In February 2021, in light of rising revenue expectations, the forecast for investments for the 2021 fiscal year was increased to around €1.6 billion. The original intention had been to invest between €1.4 billion and €1.5 billion. At €1.5 billion, investments were below the most recent outlook, but at the upper end of the original outlook from November 2020.

Explanatory comments to the outlook for the 2022 fiscal year

The following outlook is based on current business developments and internal forecasts.

Assumed euro/US dollar exchange rate

As a globally operating organization, Infineon generates revenue not only in euros, but also in foreign currencies, predominantly US dollars. It also incurs expenses in US dollars and, to some extent, in currencies correlated to the US dollar, such as the Singapore dollar, the Malaysian ringgit and the Chinese renminbi. The impact of non-euro-denominated revenue and expenses does not always balance out. For this reason, fluctuations in exchange rates, particularly between the euro and the US dollar, influence the amounts reported for revenue and earnings. A stronger US dollar against the euro has a positive effect, whereas a weaker US dollar against the euro has an adverse effect on revenue and earnings. Excluding the effect of currency hedging instruments, the impact of a deviation of 1 US cent in the actual exchange rate of the US dollar against the euro compared to the forecast rate would amount to a change in Segment Result of approximately €5 million per quarter or approximately €20 million per fiscal year compared to the forecast value. These figures are calculated on the assumption that the exchange rates of currencies correlated with the US dollar – in which costs arise for Infineon – change in line with the euro/US dollar exchange rate. In terms of revenue, the impact of exchange rates is limited primarily to the euro/US dollar rate, where a deviation of 1 US cent in the actual exchange rate compared to the forecast rate would continue to have an impact on revenue of approximately €15 million per quarter or approximately €60 million per fiscal year. Planning for the 2022 fiscal year is based on an assumed average exchange rate of US\$1.20 to the euro.

Growth prospects for the global economy and the semiconductor market

The world economy contracted by 3.5 percent in the 2020 calendar year as a consequence of the coronavirus pandemic. A strong recovery is expected in the 2021 calendar year, with experts at the International Monetary Fund (IMF) projecting growth of 4.8 percent back in October 2020. In view of the improved growth prospects over the course of the 2021 calendar year, the IMF revised its projection upwards to 5.7 percent in October 2021, [R11](#). The rapid development and approval of effective vaccines to combat the coronavirus as well as extensive stimulus measures by many governments have contributed to the stronger recovery. However, vaccination rates remain low in some emerging and developing countries, posing a risk to the scale of the upturn going forward. Should further outbreaks or mutations of the coronavirus occur, they could result in value chain disruptions with negative consequences for the further growth of the world economy. The current shortage of certain raw materials and components caused by supply difficulties, as well as a variety of geopolitical conflicts, also pose additional risks.

The recovery of the world economy in the 2021 calendar year, after a slump in the previous year, combined with the ongoing trend towards digitalization and electrification, have driven up demand for semiconductors quite significantly in the 2021 calendar year. Market analysts at Omdia expect Infineon's reference market (i.e., the semiconductor market excluding DRAM and NAND flash memory chips and micro-processors) to grow by 18 percent in US dollar terms in the 2021 calendar year, [R09](#). Despite the pandemic and the resulting lockdowns, this market grew by 8 percent in the previous year, driven by the sharp hike in demand for data and telecommunications servers, computers and other electronic and electrical devices. In particular, demand for semiconductor chips in the automotive sector has risen sharply during the 2021 calendar year. Given the high capacity utilization rate at semiconductor fabrication plants for the aforementioned product groups, supply bottlenecks have arisen that cannot be remedied in the short term. For the 2022 calendar year, market analysts at Omdia expect the world economy to continue recovering and the Infineon reference market to grow at a rate of 5 percent, [R09](#).

Revenue forecasted to grow to €12.7 billion plus or minus €500 million

Based on the forecasts for the growth of the world economy and the semiconductor market segments relevant for Infineon described above and an assumed average exchange rate of US\$1.20 to the euro, Infineon forecasts that revenue will grow in the 2022 fiscal year to €12.7 billion plus or minus €500 million. Automotive and Connected Secure Systems segment revenue is expected to increase at a higher percentage rate than Group revenue overall. The revenue growth rate in the Power & Sensor Systems segment is forecast to be at a similar level to that of the Group. Industrial Power Control segment revenue is expected to increase by a mid-to-high single-digit percentage.

Segment Result Margin of about 21 percent expected

If the middle of the range for the revenue forecast is reached, the Segment Result Margin is expected to be around 21 percent in the 2022 fiscal year.

Free Cash Flow from continuing operations

For the 2022 fiscal year, Infineon forecasts Free Cash Flow of around €1 billion.

RoCE

For the 2022 fiscal year, Return on Capital Employed (RoCE) is forecast to reach minimum 10 percent.

Gross cash position

The gross cash position is expected to finish the 2022 fiscal year at a level of around €4 billion. The original medium-term target of reducing debt to or below the maximum target value of twice gross financial debt to EBITDA following the closing of the Cypress transaction is expected to be achieved as early as the 2022 fiscal year.

Investments and depreciation/amortization

Investments (defined by Infineon as the sum of investments in property, plant and equipment, investments in other intangible assets and capitalized development costs) are planned at around €2.4 billion for the 2022 fiscal year. The main focus is on expanding frontend manufacturing capacities that will enable Infineon to continue meeting the expected growth in demand in the medium term. Further investments in frontend facilities will be used to implement structural measures, optimize product quality, increase the degree of automation and promote innovation. A significant amount is also planned for investments at backend facilities, albeit at a much lower level than for frontend facilities. The majority of investment in buildings will be used to expand Infineon's frontend locations.

In the 2021 fiscal year, investments totaled €1,497 million, comprising €1,268 million for property, plant and equipment and €229 million for capitalized development costs and other intangible assets. In the 2022 fiscal year, investments in capitalized development costs and other intangible assets are expected to be at about the same level than in the 2021 fiscal year.

Depreciation and amortization are predicted to be between €1.6 billion and €1.7 billion. Approximately €400 million of that amount relates to depreciation and amortization resulting from purchase price allocations, mainly in connection with the acquisition of Cypress and, to a lesser degree, the acquisition of International Rectifier.

Overall statement on the expected development

Based on forecasts for the development of the global economy and the semiconductor market in the 2022 calendar year, Infineon expects Group revenue to grow to €12.7 billion plus or minus €500 million. The Segment Result Margin is forecast to come in at the middle of the range for the revenue forecast at around 21 percent of revenue. Investments are expected to be in the region of €2.4 billion. Depreciation and amortization are expected to total between €1.6 billion and €1.7 billion. Free Cash Flow from continuing operations should reach around €1 billion. The Return on Capital Employed (RoCE) is forecast to reach minimum 10 percent.

Risk and opportunity report

Risk policy: Underlying principles of our risk and opportunity management

Effective risk and opportunity management is central to all of our business activities and supports the implementation of our strategic goals and growth drivers. Infineon's risk and opportunity profile is still characterized by periods of rapid growth, followed by periods of significant market decline, a substantial need for capital investment in order to achieve and sustain our market position and an extraordinarily rapid pace of technological change. Gaining a leading edge through technological innovation also has a legal dimension. Against this background, Infineon's risk policy is aimed firstly at taking advantage of identified opportunities as quickly as possible in a way most appropriate to growing the enterprise value, and secondly at pro-actively mitigating risks – particularly those capable of posing a threat to Infineon's going-concern status – by adopting appropriate countermeasures. Risk management at Infineon is therefore closely linked to corporate planning and the implementation of our business strategies. Ultimate responsibility for risk management lies with the Infineon Management Board.

Coordinated risk management and control system elements are in place that enable us to pursue our stated risk policy in practice. Alongside the "Risk and Opportunity Management System" and the "Internal Control System with respect to financial reporting processes" described below, these elements also includes the related forecasting, management and internal reporting processes as well as the Compliance Management System.

Risk and Opportunity Management System

Infineon's centralized risk management system is based on a Group-wide, management-oriented Enterprise Risk Management (ERM) approach, which aims to cover all relevant risks and opportunities. The approach is based on the "Enterprise Risk Management – Integrated Framework" developed by the Committee of Sponsoring Organizations of the Treadway Commission (COSO). The objective of the system is the early identification, assessment and management of risks and opportunities

that could have a significant influence on Infineon's ability to achieve its strategic, operational, financial, legal and compliance targets. We therefore define risk/opportunity as the occurrence of future uncertainties that could result in either a negative or a positive variance from plan. We incorporate all relevant organizational units within the Group in this analysis, thus covering all segments, significant central functions and regions.

Responsibility for processes and systems relating to risk and opportunity management rests with the Risk Management and Internal Control System (ICS) function within the Group Finance department as well as with designated Risk Officers working at segment, corporate function and regional levels. Responsibility for the identification, measurement, management and reporting of risks and opportunities lies with the management of the organizational unit concerned.

In organizational terms, the Risk and Opportunity Management System is structured in a closed-loop, multiple-stage process, which stipulates the manner and criteria to be applied to identify, measure, manage and report on risks and opportunities and defines how the system is to be monitored as a whole. Major components of the system are a quarterly analysis of risks and opportunities, reporting by all consolidated entities, an analysis of the overall situation at segment, regional and Group level, reporting to the Management Board on the risks and opportunities situation as well as major management measures undertaken. The Management Board, in turn, reports regularly to the Supervisory Board's Investment, Finance and Audit Committee. Where necessary, standard processes are supplemented by the ad-hoc reporting of any major risks identified between regular reporting dates.

Risks and opportunities are measured cumulatively over the multi-year planning horizon on a net basis, i.e., after taking into account any existing risk mitigation or hedging measures. The time periods and the measurement categories used are closely linked to our short- and medium-term business planning and entrepreneurial targets.

All relevant risks and opportunities are assessed uniformly across the Group in quantitative and/or qualitative terms, based on the factors **degree of impact** on segment

result and/or business objectives, reputation, compliance, on the one hand, and **likelihood of occurrence**, on the other.

The scales used to measure these two factors (degree of impact and likelihood of occurrence, measured cumulatively over the multi-year planning horizon) and the resulting risk assessment matrix are depicted in chart [C40](#).

Based on the potential degree of impact as well as the estimated probability of occurrence, a risk is classified as “high”, “medium” or “low”.

All risks and opportunities reported for Infineon are reviewed for possible cumulative effects and analyzed using an Infineon-specific categorization model. Risk and opportunity analysis and new developments in risk management culture are supplemented by interdisciplinary workshops held at segment, corporate and regional levels. Important information relevant for Infineon’s Risk and Opportunity Management System is available to all employees via our intranet system, including access to ERM tools and ERM guidelines containing job descriptions for all functions involved in the process as well as all information necessary for reporting purposes.

C40 Risk assessment matrix

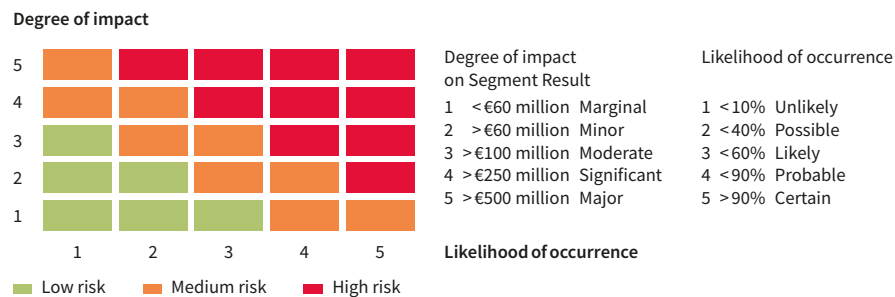

Risk and Opportunity Managers are designated at appropriate hierarchical levels to manage and monitor identified risks and opportunities. They are responsible for formally determining a set of appropriate strategies (in the case of risk avoidance, mitigation, transfer to other parties or acceptance). Working closely with corporate functions and individual managers, the Risk and Opportunity Managers are also responsible for defining and monitoring measures aimed at implementing the adopted management strategy. In order for our system to operate successfully, it is essential that risks and opportunities are managed and monitored pro-actively and with a great deal of commitment.

Compliance with the ERM approach is monitored by the corporate function responsible for risk management and ICS using procedures incorporated in business processes. Group Internal Audit also performs tests for compliance with legal requirements and Infineon guidelines and, where appropriate, rules relating to risk and opportunity management and recommends corrective measures.

The Supervisory Board’s Investment, Finance and Audit Committee oversees the effectiveness of the Risk Management System. As part of the statutory audit, the external Group auditor also examines our early warning system pursuant to section 91, paragraph 2, of the German Stock Corporation Act to ascertain its suitability to detect risks that could pose a threat to Infineon’s going-concern status and reports thereon annually to the Chief Financial Officer (CFO) and the Investment, Finance and Audit Committee of the Supervisory Board.

Internal Control System with respect to the financial reporting process

The principal focus of the Internal Control System (ICS) is on the financial reporting process, with the aim of monitoring the proper maintenance and effectiveness of accounting systems and financial reporting. The primary objective of the ICS is to minimize the risk of misstatement in Infineon’s internal and external reporting and to ensure with a reasonable amount of certainty that the Consolidated Financial Statements comply with all relevant regulations. Appropriate controls must therefore be in place throughout the organization to ensure compliance. Clear lines of responsibility are assigned to each of the processes.

The ICS is based on the “Internal Control – Integrated Framework” developed by the “Committee of Sponsoring Organizations of the Treadway Commission (COSO)” and is an integral part of the accounting process in all relevant legal entities and corporate functions.

The system monitors compliance with stated principles and stipulated procedures based on preventive and detective controls. Among other things, we regularly check that:

- › Group-wide financial reporting, measurement and accounting guidelines are continually updated and adhered to;
- › intragroup transactions are fully accounted for and properly eliminated;
- › issues relevant for financial reporting and disclosures in connection with agreements entered into are recognized and appropriately presented;
- › processes and controls are in place to explicitly guarantee the completeness and correctness of the year-end financial statements and financial reporting; and
- › processes are in place for the segregation of duties and for the dual control principle in the context of preparing financial statements, as well as for authorization and access rules for relevant IT accounting systems.

Assessment of effectiveness

We systematically assess the effectiveness of the ICS with regard to the corporate accounting process. An annual risk analysis is initially performed, and the defined controls are revised, as and when required. The assessment involves identifying and updating significant risks relating to accounting and financial reporting in the relevant legal entities and corporate functions. The controls defined for identifying risks are documented in accordance with Group-wide guidelines. Regular random tests are

performed to assess the effectiveness of these controls. The tests constitute the basis for assessing the appropriateness of design and the effectiveness of the controls. The results are documented and reported in a global IT system. Any deficiencies identified are remedied, with due consideration given to their potential impact.

Furthermore, in a Representation Letter, all legal entities, segments and relevant corporate functions confirm that all business transactions, all assets and liabilities and all income and expense items have been recognized in the financial statements.

At the end of the annual cycle, the material legal entities review and confirm the effectiveness of the ICS with regard to the accounting and financial reporting process. The Management Board and the Investment, Finance and Audit Committee of the Supervisory Board are regularly informed about any significant control deficiencies and the effectiveness of the internal controls.

Both the Risk and Opportunity Management System and the Internal Control System are continuously developed and expanded to ensure compliance with internal and external requirements. Regular improvements made to these systems contribute to the continuous monitoring of the relevant risk areas, including the responsible organizational units.

Cypress' ICS is being continuously integrated into the Group's ICS in conjunction with the merger of legal entities and processes.

Significant risks

In the following section, we describe risks that could have a significant or material adverse impact on the Segment Result and/or business objectives, reputation, or compliance, and which have therefore been allocated to the risk classes “high” or “medium”. Unless otherwise stated, the risks described apply to all segments. Depending on the potential degree of impact and the estimated likelihood of occurrence, the risk class is shown in parentheses for each risk (e.g., “RC: high”).

Strategic risks

Unsettled political and economic climate (RC: high)

As a globally operating company, our business is highly dependent on global economic developments. A worldwide economic downturn – particularly in the markets we serve – may result in us not achieving our forecasted revenue and contribution to earnings. Risks can also arise due to political and social changes, in particular when those changes occur in countries in which we manufacture and/or sell our products.

Trade and customs disputes as well as trade restrictions, for instance between the USA and China, could constrain global trade, thereby dampening global economic growth. Such developments can be triggered by political tensions and/or trade conflicts between individual countries or regions, which – as a result of short-term and sometimes unforeseeable decisions – could have a significant impact on Infineon's revenue and earnings.

Our relative dependence on the Chinese market in relation to the total group revenue of business remains essentially unchanged. This includes the risk of a decline in external demand from a Chinese perspective and hence a decline in manufacturing capacity utilization levels in China. There is also a risk that an increased volume of previously imported semiconductors will be manufactured in China and that a greater volume of those made in that country will be exported.

The government debt situation has worsened considerably as a result of the economic stimulus programs launched to mitigate the consequences of the coronavirus pandemic. Regardless of our assessment of potential scenarios and outcomes within this complex set of risks, these developments could have an adverse impact on Infineon's business operations, financial condition, liquidity, cash flows and earnings.

Cyclical market and sector development (RC: high)

The worldwide semiconductor market is dependent on global economic growth and hence subject to fluctuations. Our target markets are exposed to the risk of short-term market fluctuations. As a result, our own forecasts of future business developments

are subject to a high degree of uncertainty. It is possible, for instance, that future market downturns will follow another pattern, for example, an L-shape with longer periods of flat growth. The absence of market growth or its decline would make it considerably more difficult to attain our own growth targets. In the event that we are unprepared for market fluctuations, or our response to any such fluctuations turns out to be inappropriate, this could have a sustained materially adverse impact on Infineon's operations, financial condition, liquidity, cash flows and earnings.

Increased market competition and commoditization of products (RC: high)

The rapid pace of technological change in the market also results in a greater replaceability of products. Due to the resulting aggressive pricing policies, we may be unable to achieve our long-term strategic goals of gaining and/or maintaining market share and of product pricing. Moreover, accelerating M&A (Merger & Acquisition) activity within the semiconductor industry could result in even tougher competition. Potential benefits for competitors in this market include improved cost structures and more effective sales channels. Overall, this situation could have an adverse impact on Infineon's earnings.

Risks arising from the coronavirus pandemic (RC: medium)

In the 2020 fiscal year, the rapid spread of the coronavirus pandemic led to a significant deterioration in global economic conditions and also had an adverse effect on Infineon's operations and earnings. By the second half of the 2020 calendar year, the global economy had recovered unexpectedly quickly, leading to a massive increase in demand for semiconductors and significantly mitigating the impact of the coronavirus pandemic in the 2021 fiscal year. However, the pandemic continued to disrupt manufacturing output in certain countries, affecting not only Infineon's sites, but also those of its international suppliers and customers, which continues to negatively impact the availability of raw materials and components as well as Infineon's revenue. These risks could be exacerbated if the coronavirus pandemic were to flare up again. The coronavirus pandemic and indeed any other pandemic, epidemic or outbreak of infectious disease could have a materially adverse effect on the business operations, earnings, liquidity and cash flows of the Group.

Operational risks

Dependence on individual suppliers (RC: high)

We cooperate with numerous suppliers who provide us with materials and services or manage parts of our supply chain. We do not always have alternative sources for some of these suppliers and therefore depend on their ability to deliver products and services of the required quality. The unexpectedly high demand for semiconductor products in the 2021 fiscal year – particularly for the automotive market, renewable energy applications, data centers, the expansion of mobile communications infrastructure, many aspects of digitalization and the electronics used at work and in homes in general – continues to cause supply problems, particularly for our contract manufacturers. The situation has not only led to delays in supplying our customers, but also resulted in an actual loss of revenue during the period under report. At the same time, we are currently confronted with price increases from suppliers and there is a risk that it will not be possible to fully pass on these increases to our customers. Cypress' business operations, in particular, rely heavily on independent contract manufacturers and subcontractors to manufacture its products, including wafer fabrication, assembly, packaging and testing. Any failure of one or more of these suppliers to meet their obligations to Infineon could have an adverse impact on Infineon's business operations, liquidity and earnings.

Data and IT systems security (RC: high)

The reliability and security of Infineon's IT systems are of crucial importance. At the same time, the world has seen a general rise in the level of threats to data security. This applies to the deployment of IT systems to support business processes, on the one hand, and internal and external communications, on the other. Despite the array of precautionary measures put in place, any major disruption to these systems could result in risks relating to the confidentiality, availability and reliability of data and systems used in development, manufacturing, selling or administration functions, which, in turn, could have an adverse impact on our reputation, competitiveness and operations.

Potential cyber-attacks on IT systems used in manufacturing processes, present risks that could result in production downtime and supply bottlenecks. In addition,

cyber-attacks with industrial espionage intent and any related potential loss of intellectual property or patents pose risks that could jeopardize our investment in research and development and impair our long-term competitiveness.

Increasingly dynamic markets (RC: high)

The accelerating pace of events in the markets in which we operate, increased demands for flexibility by our customers, and short-term changes in order volumes could result in rising costs due to the underutilization of manufacturing capacities, higher inventory levels and unfulfilled commitments to suppliers.

Thus, despite the fact that manufacturing processes and sites have become even more flexible, fluctuations in capacity utilization levels and purchase commitments, coupled with idle costs at manufacturing sites, nevertheless pose risks related to our cost position. These risks could possibly jeopardize our ability to achieve growth and profitability targets that are based on cycle averages.

This situation is exacerbated by the fact that some of our products are highly dependent on the degree of success achieved by individual customers in their own markets. Furthermore, there is a risk of losing future business and design wins if we are unable to deliver volumes over and above our contractual obligations if called upon by customers to do so. These factors could have an adverse impact on Infineon's liquidity and earnings.

Dependence on the success of specific customers may also grow if they account for an above-average share of Infineon's revenue and earnings. This situation could be driven by the exceptionally strong performance of a particular customer, resulting, for instance, from exceptional demand for its products or from consolidation trends, in particular those affecting our first- and second-tier customers.

Product quality trends (RC: medium)

Product quality assurance is a key success factor for our business. Potential quality risks – for example due to high capacity utilization levels – can affect yield fluctuations and hence our ability to supply customers. Shortfalls in product quality can lead

to product recalls at our customers and related potential costs for liability claims. In addition, quality risks could also damage Infineon's reputation and thus have a significant adverse impact on future earnings.

Product development delays (RC: medium)

The ever-increasing complexity of technologies and products, shorter development cycles and higher customer expectations can cause a great deal of tension in the field of product development. Buffer times built into processes to compensate for potential delays are reduced accordingly. In the event of being unable to execute our development plans at the desired quality levels, the outcome could be development delays and increased development costs, which could have an adverse impact on Infineon's operations, financial condition, liquidity, cash flows and earnings.

Manufacturing cost trends – raw materials prices, cost of materials and process costs (RC: medium)

Our medium- and long-term forecasts are based on expected manufacturing cost trends. In this context, measures aimed at optimizing manufacturing costs for raw materials and supplies, energy, labor and automation, as well as for bought-in services from external business partners, may not be feasible to the extent envisaged.

Moreover, our dependence on various components (such as wafer substrates) and raw materials (such as gold and copper) used in manufacturing, as well as our energy requirements expose us to substantial price risks. We are also dependent on supplies of the so-called rare earths required for selected manufacturing processes in conjunction with production process integration. At the time of writing, financial instruments are in place to hedge our price risk exposure for gold wire during the 2022 fiscal year, based on the planned volume requirements. The prices of raw materials and energy have recently been subject to significant fluctuation and there is no reason to assume the situation will change in the near future. If we are unable to offset cost rises or pass them on to customers via price adjustments, it could have an adverse impact on earnings.

Determining and adjusting manufacturing volumes (RC: medium)

Frontend and backend manufacturing processes need to be optimally synchronized to enable Infineon to develop competitive, high-quality products designed to provide customized technological solutions. In view of the rapid pace of technological change and increasingly stringent customer requirements, coordination processes need to become increasingly sophisticated. Failure to continue making progress in this area could result in quality problems, product development or market maturity delays as well as higher research and development expenses and hence adversely impact Infineon's earnings.

One risk that semiconductor companies operating in-house manufacturing facilities typically face is that of delays in the ramping up of production volumes at new manufacturing sites or in the transfer of technology. One good example is in the Automotive segment, where customers' product approval and testing processes can be conducted over an extended period of time, thus influencing our global manufacturing strategy as well as short- and medium-term capacity utilization. Failure to anticipate these changes in the manufacturing process in good time could result in capacity shortages and hence lower revenue, on the one hand, as well as costs incurred due to underutilization, on the other.

Dependence on individual manufacturing sites (RC: medium)

Our South-East Asian manufacturing sites are of critical importance for our production. If, for example, political upheavals, natural disasters or pandemic outbreaks in the region were to restrict or completely obstruct our ability to manufacture at these sites on the planned scale or to export products manufactured at those sites, it would have an adverse impact on our financial condition, liquidity and earnings. Our current manufacturing capacities in this region are, to a large extent, not insured against political risks such as the expropriation of assets. The transfer of manufacturing capacities from these sites would, therefore, not only involve a great deal of time and technical effort, but Infineon would also be required to bear the necessary cost of investment.

Need for qualified staff (RC: medium)

One of the key factors in our success is the availability of sufficient numbers of qualified employees at all times. There is, however, a general risk of losing qualified staff or not being able to recruit, train and retain adequately qualified people within the business. A lack of technical or management staff could, among other things, restrict future growth and hence adversely impact Infineon's liquidity and earnings.

Financial risks**Currency risks (RC: medium)**

Our involvement and participation in various regional markets around the world creates cash flows in a number of currencies other than the euro – primarily in US dollars. A significant share of revenue, on the one hand, and of operating costs and investments, on the other, is denominated in US dollars and correlated currencies. For the most part, Infineon generates a US dollar surplus from these transactions. The integration of Cypress has increased this surplus.

Specified currencies are hedged Group-wide by means of derivative financial instruments. These hedges are based on forecasts of future cash flows, the occurrence of which is uncertain. Under these circumstances, exchange rate fluctuations could – despite hedging measures – also have an adverse impact on earnings.

Risk of default by banking and financing partners (RC: medium)

The relatively high level of our holdings of liquid funds (gross cash position) exposes us to the potential risk of a default by one or more of the banking and financing partners with whom we do business. We mitigate this risk – which could still arise despite various state-insured deposit protection mechanisms – by a combination of risk avoidance analyses and risk-spreading measures. The failure of these measures could have a materially adverse impact on Infineon's financial condition and liquidity situation.

Further information regarding the management of financial risks is provided in note 27 to the Consolidated Financial Statements. [p. 211 ff.](#)

Legal and compliance risks**Qimonda insolvency (RC: medium)**

The insolvency proceedings relating to Qimonda and the resulting actions of the insolvency administrator expose Infineon to potential risks, which are described in detail in note 23 to the Consolidated Financial Statements. [p. 198 f.](#)

Provisions are recognized in connection with these matters as of 30 September 2021. The provisions reflect the amount of those liabilities that management believes are probable and can be estimated with reasonable accuracy as of that date. There can be no assurance that these provisions will be sufficient to cover all liabilities that may be incurred in conjunction with the insolvency proceedings relating to Qimonda.

Intellectual property rights and patents (RC: medium)

As with many other companies in the semiconductor industry, from time to time allegations are made against us that we have infringed other parties' protected rights. Regardless of the prospects of success of such claims, substantial legal defense costs can arise.

Whilst we often benefit from cross-licensing arrangements with major competitors, no such opportunities exist to safeguard against risks of this nature in the case of companies specializing in the exploitation of patent rights.

We cannot rule out that patent infringement claims will be upheld in a court of law, thus resulting in significant claims for damages or restrictions in selling the products concerned. Any such outcome could, in turn, have an adverse impact on Infineon's financial condition, liquidity and earnings.

Further information regarding litigation and government inquiries is provided in note 23 to the Consolidated Financial Statements. [p. 198 ff.](#)

Impact of our global operations (RC: medium)

Our global business strategy requires the maintenance of research and development locations and manufacturing sites throughout the world. The location of such facilities is determined by market entry hurdles, technology and cost factors. Risks could,

therefore, arise if adverse economic and geopolitical crises were to affect our regional markets and if country-specific legislation and regulations were to influence investment activities and the ability to trade freely. Differing practices in the way tax, judicial and administrative regulations are interpreted could also have a negative impact on operations. We could also be exposed to the risk of fines, sanctions and reputational damage.

Asian markets are particularly important to our long-term growth strategy. Our operations in China are influenced by a legal system that may be subject to change. One example is the fact that local regulations could make it mandatory to enter into partnerships with local companies. These circumstances could lead, on the one hand, to Infineon's intellectual property no longer being sufficiently protected and, on the other, to intellectual property developed by Infineon in China not being freely transferable to other countries and locations, thus impairing Infineon's financial condition and earnings.

Acquisitions and cooperation arrangements (RC: medium)

In order to develop or expand our business, we may seek to acquire other businesses or enter into various forms of cooperation arrangements. In the case of acquisitions, there is a risk that these activities prove to be unsuccessful, particularly regarding the integration of people and products in existing business structures. These issues could adversely impact our financial condition and earnings performance.

In the case of acquisitions or portfolio decisions, there is a risk of non-compliance with antitrust regulations due to lack of knowledge or failure to make the people involved in such transactions adequately aware of the issues. This could result in high levels of cost (e.g., significant time spent by management, assignment of attorneys) and fines. Infineon's reputation could also suffer under these circumstances.

Tax, fair trade and capital market regulations can all entail additional risks. In order to mitigate these risks, we rely upon the advice of both in-house and external experts and provide suitable training to our employees.

Non-achievement of strategic or operational targets and risks relating to the integration of Cypress (RC: medium)

The strategic and operational targets we have set with respect to the acquisition and integration of Cypress are based on assumptions and estimates that may subsequently prove to be incorrect. These include the financial and operational performance of Cypress and the synergy and innovation potential of the two companies as well as future economic developments and market changes.

In the event of unexpected difficulties in terms of integration, the weaker-than-forecast growth of Cypress-related business or other unforeseen deviations in business development could potentially force us to recognize an impairment loss on non-current assets and/or on goodwill arising from the acquisition of Cypress.

In particular, the possible loss of key employees could also have a negative impact. As a prerequisite for the successful integration and implementation of a joint strategy, we need talented managers and employees from both Infineon and Cypress. If, for instance, we are unable to retain employees due to potential uncertainties regarding jobs, locations or corporate culture, the benefits of integration and the ability to exploit the respective strengths of the two companies may be impaired.

Measures to implement our risk management strategy

At a strategic risk level, we endeavor to mitigate the typical risks that arise in the semiconductor sector due to economic and demand fluctuations and the risks related to Infineon's operations, financial condition, liquidity and earnings by closely monitoring changes in early warning indicators as well as by developing specific response strategies appropriate to the current position within the economic cycle. This can be done, for instance, by rigorously adjusting capacities and inventory levels at an early stage, initiating cost-saving measures and making flexible use of external manufacturing capacities at both frontend and backend facilities.

At an operational level, we have adopted various quality management strategies aimed at avoiding quality risks (such as “Zero Defects” and “Six Sigma”) in order to prevent or solve problems and to improve our business processes. Our Group-wide quality management system has been certified on a worldwide basis in accordance with ISO 9001 and ISO/TS 16949 for a number of years and also encompasses supplier development. Our processes and initiatives to ensure continuous quality improvement in corporate procedures are aimed at identifying and eliminating the causes of quality-related problems at an early stage.

A structured project management system is in place to handle development projects, including those of a customer-specific nature. Clear project milestones and verification procedures required to be carried out during a project, as well as clearly defined limits of authority, help us identify potential project risks at an early stage and counter these risks with specific measures.

We seek to minimize procurement-related risks through appropriate purchasing strategies and techniques, including constant product and cost analysis (“Best Cost Country Sourcing” and “Focus-on-Value”). These programs include cross-functional teams of experts who are responsible for standardizing purchasing processes with respect to materials and technical equipment.

In order to take the growing importance of Infineon’s ecosystem partners into account, a partner risk evaluation system for Go2Market and IP/R&D partners has been developed and integrated. This partner risk assessment focuses on the dependency of Infineon from its ecosystem partners. As a result, the high risk ecosystem partners throughout the group are now identified, continuously assessed and corrective risk mitigation measures are implemented to avoid an adverse impact on the Segment Result and/or business objectives, reputation, compliance.

In response to the general increase in threats to data security and the high degree of professionalism meanwhile applied in the area of cybercrime, we have initiated an

information security program to further improve protection against hacking attacks and related risks to our IT systems, networks, products, solutions and services. Information security is achieved primarily with the aid of Infineon’s systematically applied global Information Security Management System (ISMS), the prime objectives of which are to identify and measure all potential IT risks and to ensure that effective processes and tools are in place to minimize and avoid risk. The ISMS covers all areas of Infineon’s business and is certified in line with the globally recognized ISO/IEC 27001 standard. All relevant risk areas are continuously monitored and optimized in conjunction with regular internal and external audits.

We minimize legal risks relating to intellectual property rights and patents by pursuing a well-defined patent strategy, including thorough patent research and the selective development and registration of Infineon patents, as well as precautionary protective measures in the form of agreements with major competitors. However, no such opportunities exist to safeguard against risks of this nature in the case of companies that specialize in exploiting patent rights.

We have implemented a Group-wide Compliance Management System (CMS) with the aim of managing Compliance-related risks in a systematic, comprehensive and sustainable manner. We are continuously enhancing the seven elements of our CMS to prevent, detect and respond to Compliance-related incidents. The Corporate Compliance Officer reports to the Chief Financial Officer and, on a quarterly basis, to the Management Board and to the Investment, Finance and Audit Committee of the Supervisory Board. At entities or sites formerly operated by Cypress, we have appointed Compliance Contacts, who are responsible for the implementation of the CMS at the entities or sites.

In certain cases, insurance policies have been taken out to protect against potential claims and liability risks, with the aim of avoiding or at least minimizing any adverse impact on Infineon’s financial condition and liquidity.

Overall statement by Group management on the risk situation

The overall risk assessment is based on a consolidated view of all significant individual risks. The risk situation as a whole remains essentially unchanged from the previous year. We are not currently aware of any individual risks capable of jeopardizing Infineon's going-concern status.

Opportunities

The principal opportunities are described in the following section. The list is not exhaustive and represents only a cross-section of the opportunities available. Our assessment of these opportunities is subject to continuous change, reflecting the fact that our business, our markets and the technologies we deploy are continuously subject to new developments, bringing with them fresh opportunities, causing others to become less relevant or otherwise changing the significance of an opportunity from our perspective. Depending on the potential degree of impact and the estimated probability of occurrence, each of these opportunities is assigned to an "opportunity class" (OC) in the same way that risks are allocated to a risk class. These classifications are shown in parentheses (e.g., "OC: medium").

High demand for semiconductors allows price increases (OC: high)

The worldwide high demand for semiconductor products is predicted to continue in the 2022 fiscal year and gives us the opportunity to increase our sales prices. This may have a positive impact on Infineon's business operations, liquidity and earnings.

Opportunities arising in connection with the acquisition and integration of Cypress (OC: medium)

The products and technologies of Infineon and Cypress complement one another in an outstanding manner. The previous focus on power semiconductors, sensors and microcontrollers for automotive and security applications has now been broadened to include connectivity-related products, multi-purpose microcontrollers for industrial and IoT applications together with the related software, as well as memories for specialty applications ("grow in scope").

The resulting comprehensive portfolio enables Infineon to offer complete system solutions that are needed to link the real with the digital world. The key to success is ensuring secure connectivity for energy-efficient devices. Advances in functional integration mean that a whole host of relevant applications are currently in an early phase of growth.

We are pushing ahead with our strategic approach "Product to System" in order to strengthen and expand core business by growing in both related and new fields. To cite two examples, firstly, the combination of Infineon's security expertise with Cypress' connectivity knowhow will accelerate entry into new IoT applications in the industrial segment. Secondly, in the field of automotive semiconductors, the expanded portfolio of microcontrollers and NOR flash memories offers great potential, especially in light of their growing importance for driver assistance systems and new electronic architectures in vehicles.

Quite apart from their product portfolios, the two companies also complement each other in further aspects. We also see an excellent match in terms of geographical focus and sales channels, with Infineon gaining wider market access through Cypress, particularly in Japan, as well as via distributors. Infineon will also be adding to its research and development presence in Silicon Valley. On account of its product portfolio, the manufacturing strategy of Cypress focuses to a much greater extent on contract manufacturing. The combination of the two companies will help our business diversify, make it more robust and enable us to generate additional synergies.

New technologies and materials (OC: medium)

We are constantly striving to develop new technologies, products and solutions and to improve on existing ones, both separately and in collaboration with customers. We therefore continually invest in research and development relating to the use of new technologies and materials. Those in current use may well lose their predominance in the foreseeable future, such as Si, which is reaching its physical limits in some applications.

We see numerous opportunities for working with new materials, such as those associated with SiC or GaN, to develop more powerful and/or lower-cost products. These materials could well have a positive influence on our ability to attain our strategic growth and profitability targets.

Strategic approach “Product to System” (OC: medium)

With the strategic approach “Product to System” we seek to identify additional benefits for our customers at a system level from within our broad portfolio of technologies and products. This strategy enables us to exploit further revenue growth potential and thereby achieve our growth and margin targets. This approach also enables us to reduce customers’ development costs and shorten the lead times required to bring their products to market.

Support for change in energy policies and consideration of climate change issues (OC: medium)

Population growth and increasing industrialization in all parts of the world are resulting in an ever-greater global demand for energy. Electric power is becoming the most important energy carrier of the 21st century and renewables are playing a key role in reducing carbon emissions. The long-term objective is to achieve global decarbonization by the end of the century, as resolved at the Climate Change Conference held in Paris (France) in December 2015. As part of its Green Deal concept, the European Union intends to become carbon-neutral by 2050.

Infineon’s semiconductors enable electric power to be generated from renewable energy sources. They offer efficiency gains at all stages of the energy industry’s value chain, whether in generation, transmission or, above all, in the use of electric power. They form the basis for the intelligent and efficient use of electric power, for instance, in industrial applications, power supplies for computers, consumer electronics and vehicles.

Digitalization (OC: medium)

The trend towards digitalization offers substantial business potential for Infineon. This is partially reflected in the optimization of internal processes, such as for our interconnected manufacturing capabilities on a global scale. At the same time, our portfolio of sensors, microcontrollers, power semiconductors, security controllers and specific software puts us in an excellent position to exploit growing market potential. Our strategic approach “Product to System” makes us ideally placed to penetrate and develop the markets involved. Good examples already visible today include automated driving, voice and gesture control for devices and machines, the advancing development of the IoT and big data.

Ability to meet supply requirements with available capacities (OC: medium)

Our in-house manufacturing capacities, together with those of our external partners, provide us with a degree of flexibility to meet demand. In particular, the further expansion of 300-millimeter production in Dresden (Germany), the second manufacturing module in Kulim (Malaysia), and the recent start of production of a second, fully automated 300-millimeter factory at the Villach site (Austria) will strengthen our ability to meet the growing demand for power semiconductors.

Market access and activities in China (OC: medium)

Infineon generates more revenue in China than in any other country. Accordingly, developments and growth opportunities in China are of the utmost importance to the Group and relate to the following markets that we serve:

China is the world’s largest automotive market, with growth rates still at a high level. In particular, the rapid growth in the production of plug-in hybrid and all-electric vehicles means that China has been the world’s largest market for electromobility for a number of years. For this reason, during the 2018 fiscal year, Infineon and SAIC Motor (China’s largest car manufacturer) established SIAPM, a joint venture that offers power semiconductor solutions for electric vehicles. Volume production has already commenced. The joint venture strengthens our position in China, whilst also offering additional potential for Infineon’s global business going forward.

China is the world's largest market for trains and, with CRRC (an Infineon customer), the country is home to the world's largest train manufacturer by far. The continued expansion of China's rail network and the growing volume of international infrastructure projects both represent growing business opportunities for Infineon.

At the G20 summit held in Hangzhou (People's Republic of China) in September 2016, China ratified the Paris Agreement, thereby giving its formal commitment to reducing carbon emissions. As a consequence, the importance of expanding renewable energy sources in China increased enormously. Our presence in this market, alongside our collaboration with leading companies in the wind and solar power sectors, will create further opportunities for long-term growth.

Our success in positioning Infineon in China as an integral part of Chinese industry (and hence of Chinese society) could well open up a multitude of new opportunities that is highly likely to have a positive impact on the growth and profitability of our business.

Further growth of semiconductor content in vehicles (OC: medium)

We expect semiconductor content per vehicle to continue growing. The primary driving force behind this trend is the rising demand for electromobility, active safety features and driver assistance systems.

We are also convinced that current global carbon emissions targets cannot be achieved without further electrification. The need for increased efforts in this field is relevant not only for electromobility (i.e., hybrid, plug-in hybrid and all-electric vehicles), but also for power units in vehicles with combustion engines. IT security within the vehicle is also further gaining in importance. Our expertise in the field of security controllers makes us extremely well positioned to exploit opportunities in this area.

Growth from mobile applications (OC: medium)

The ongoing trend towards increased mobility is also reflected in the unbroken high demand for smartphones and tablets. We benefit from this development in two ways. Firstly, through the components we supply for mobile devices (MEMS microphones, TVS diodes, GPS signal amplifiers, CMOS-RF switches), and secondly, through power semiconductors, which form the key components for energy-efficient chargers (high-voltage and low-voltage power transistors, driver ICs and control ICs).

Security applications (OC: medium)

The trend towards electronic identity documents continues to have a positive impact on Connected Secure Systems segment revenue. Paper-based documents are increasingly being replaced by chip-based versions, due to the higher level of security they offer. New markets are also emerging in conjunction with the IoT and the Industrial Internet ("Industry 4.0"). The authentication of devices is playing an increasingly important role in both of these fields, for which Infineon offers the corresponding security chips.

Liquidity position (OC: medium)

Our current liquidity position, which we describe in the chapter "Review of liquidity", [p. 105 ff.](#), enables us to obtain and, if necessary, make use of favorable refinancing conditions.

Overall statement on Infineon's financial condition

Signs of an economic recovery following the outbreak of the coronavirus pandemic began to appear about one year ago. These indications quickly gathered steam across many markets and geographies, soon leading to a stronger-than-expected economic rebound and an unprecedented global chip shortage. Manufacturing capacities became, and continue to be, the limiting factor, even more so as natural disasters and regional Covid spikes caused specific disruptions. In this challenging environment, we rapidly switched our operational mode from managing the under-utilization to handling severe allocation.

And that picture remains valid today: demand is by far outstripping supply. Near-term indicators tell us that the positive momentum in our key markets is intact, whereas, in a few applications with lower relevance for us, we see some normalization. Overall, the speed of growth is determined by the speed by which additional capacity is becoming available.

For the time being, supply constraints remain pervasive, and demand is strong across a large majority of product categories and end markets. Supply is bound to catch up with demand eventually, but we do not see this happening on a broader scale within 2022.

Current issues with allocation have only strengthened our view that we also need to champion our own manufacturing. The most critical bottlenecks arose for products that come from foundries – in some product categories, we are dependent on their supplies, as well. However, we are less dependent on foundries than competitors with fabless business models and, if we look across our entire portfolio, we are more resistant to supply problems. We have continued to develop our collaboration with contract manufacturers and have broadened our supplier base, so that in the future we will be even better equipped to deal with fluctuations in the supply situation.

A significant element of our strategic evolution is the expansion of our own manufacturing landscape. Without a doubt, the most important milestone was the opening of our new 300-millimeter semiconductor manufacturing facility in Villach (Austria) on 17 September 2021. We will operate the new factory, together with our factory in Dresden (Germany), as one unit, based on the One Virtual Fab concept, which gives us more flexibility and greater economies of scale.

We are continuing the process of aligning our product portfolio with the two key trends of the current and the next decade; namely, electrification and digitalization. Both trends and the interplay between them will accelerate structural semiconductor growth. The general market picture and our business situation continue to look very positive. This is reflected in our recent numbers:

Infineon generated **revenue** of €11,060 million in the 2021 fiscal year, an increase of 29 percent compared to the previous year's figure of €8,567 million.

The **Segment Result** totaled €2,072 million for the 2021 fiscal year, 77 percent up on the €1,170 million reported one year earlier. The **Segment Result Margin** rose accordingly, coming in at 18.7 percent compared to 13.7 percent one year earlier.

Investments during the 2021 fiscal year totaled €1,497 million, up €398 million or 36 percent on the previous year's figure of €1,099 million. The increase was slightly more pronounced than revenue growth, reflecting the strong upturn in demand. Investments as a percentage of revenue edged up from 12.8 percent to 13.5 percent year-on-year.

Free Cash Flow from continuing operations in the 2021 fiscal year was a positive amount of €1,574 million (2020: negative €6,727 million) and arose mainly due to the high level of net cash provided by operating activities from continuing operations totaling €3,063 million (2020: €1,817 million). The figure reported for the previous fiscal year was influenced primarily by the net payment (i.e., net of cash and cash equivalents acquired) amounting to €7,433 million used to acquire Cypress.

Infineon Technologies AG

The **Return on Capital Employed (RoCE)** improved from 3.0 percent to 8.4 percent year-on-year, mainly reflecting the sharp rise in **operating profit from continuing operations after tax** from €473 million to €1,325 million compared with one year earlier. **Capital employed** stood at €15,793 million as of 30 September 2021 and was therefore similar to the amount reported one year earlier (30 September 2020: €15,827 million).

Outlook

For around three quarters now, we have been talking about the imbalance between supply and demand, caused by the pandemic, cyclical tailwinds and structural factors. In general terms, a stabilization of this boom phase is occurring at present. In the majority of markets, capacities are tight and inventories are lower-than-healthy. Demand is outstripping supply but not accelerating further from elevated levels. Stock levels in some areas are going slightly up, while staying considerably below long-term averages. Of course, dynamics are different in the various sub-markets; in some, a supply-demand equilibrium will be reached sooner than in others. For our target applications, however, we do not see this happening in the near future. Supply limitations for automotive, industrial, data center, IoT and other areas will persist well into 2022. As a consequence, our outlook for the 2022 fiscal year is determined from the supply side, that is, by the extent by which we can expand capacities, both in-house as well as from external manufacturing partners.

Based on the forecasts for the development of the global economy and the semi-conductor market in the 2022 calendar year, the company expects an increase in Group revenue to around €12.7 billion plus or minus €500 million. The Segment Result Margin is forecast to come in at the middle of the range for the revenue forecast at around 21 percent of revenue. Investments are expected to be in the region of €2.4 billion. Depreciation and amortization are expected to total between €1.6 billion and €1.7 billion. Free Cash Flow from continuing operations should reach around €1 billion. The Return on Capital Employed (RoCE) is forecast to reach minimum 10 percent.

In addition to reporting on Infineon as a whole, in the following section, we also provide information on the performance of Infineon Technologies AG.

Infineon Technologies AG is the parent company of Infineon and performs the Group's management and corporate functions. It is responsible for key Group-wide functions such as Finance and Accounting, Treasury Management, Investor Relations, Corporate Compliance, Internal Audit, Business Continuity, Business Excellence, Information Technology, Strategy, Mergers and Acquisitions, Legal and Patent Department, Human Resources, strategic and product-oriented research and development activities and also Corporate and Marketing Communication worldwide. Furthermore, it manages supply chain processes throughout the Group. Infineon Technologies AG also has its own manufacturing facilities, located in Regensburg and Warstein (both in Germany).

Unlike the Consolidated Financial Statements, which are prepared in accordance with International Financial Reporting Standards ("IFRS"), Infineon Technologies AG's Separate Financial Statements are prepared in accordance with the provisions of the German Commercial Code ("HGB"). The complete Separate Financial Statements are published separately.

Earnings position

Statement of income of Infineon Technologies AG in accordance with the German Commercial Code (condensed)

€ in millions	2021	2020
Revenue	6,311	5,346
Cost of goods sold	(4,133)	(3,745)
Gross profit	2,178	1,601
Research and development expenses	(1,203)	(1,091)
Selling expenses	(444)	(370)
General and administrative expenses	(229)	(198)
Other income (expense), net	26	(2)
Result from investments, net	64	270
Interest result	(147)	(141)
Other financial result	36	(216)
Income tax	(42)	(3)
Income after taxes/net profit (previous year: net loss)	239	(150)
Transfers from retained earnings	114	437
Unappropriated profit at the end of year	353	287

The unchanged high demand for semiconductor products, which resulted in positive volume and price effects, led to an increase in revenue of Infineon Technologies AG of 18 percent to €6,311 million (2020: €5,346 million) and an increase in gross profit of 36.0 percent year-on-year to €2,178 million (2020: €1,601 million). The gross profit margin amounted to 34.5 percent in the 2021 fiscal year (2020: 29.9 percent). This development led to an increase in functional costs of €217 million to €1,876 million in the 2021 fiscal year (2020: €1,659 million), amounting to 29.7 percent of revenue (2020: 31.0 percent). Infineon Technologies AG reports net profit of €239 million for the 2021 fiscal year after a net loss of €150 million for the 2020 fiscal year. Besides an increase in gross profit, a decrease in financial expenses related to the acquisition of Cypress was recorded. This was offset by a declining income from investments and an increase of expenses by function. After transferring a total of €114 million from retained earnings, unappropriated profit amounted to €353 million.

Net assets and financial position

Statement of financial position of Infineon Technologies AG in accordance with the German Commercial Code (condensed)

€ in millions	30 September 2021	30 September 2020
Intangible assets, property, plant and equipment	592	692
Financial assets	12,446	12,266
Non-current assets	13,038	12,958
Inventories	1,257	1,207
Receivables and other assets	1,872	1,659
Cash and cash equivalents, marketable securities	3,656	2,587
Current assets	6,785	5,453
Prepaid expenses	121	116
Active difference resulting from offsetting	2	2
Total assets	19,946	18,529
Share capital	2,603	2,601
Capital reserves	3,525	3,515
Retained earnings	3,007	3,116
Unappropriated profit	353	287
Shareholders' equity	9,488	9,519
Special reserve with an equity portion	-	1
Provisions for pensions and similar commitments	321	304
Other provisions	808	725
Provisions	1,129	1,029
Bonds	4,634	4,634
Loans payable to banks	2	-
Advance payments received	1	-
Trade payables	378	341
Liabilities to affiliated companies	3,430	2,125
Other liabilities	883	878
Liabilities	9,328	7,978
Deferred income	1	2
Total liabilities and shareholders' equity	19,946	18,529

Total assets increased by 7.6 percent from €18,529 million as of 30 September 2020 to €19,946 million as of 30 September 2021. Non-current assets went up by €80 million year-on-year due to capital contributions at the level of affiliated companies while intangible assets and property, plant and equipment decreased. Current assets increased by €1,332 million, mainly due to an increase of cash and cash equivalents and marketable securities by €1,069 million to €3,656 million at the end of the reporting period (30 September 2020: €2,587 million). Cash and cash equivalents and marketable securities accounted for 53.9 percent of current assets. Receivables and other assets increased in total by €213 million due to the higher volume of business.

The decrease in equity (€31 million) was mainly due to the dividend paid out for the 2020 fiscal year amounting to €286 million and, with an offsetting effect, the net profit for the 2021 fiscal year amounting to €239 million.

Provisions for pensions and similar commitments increased by a total of €17 million, mainly due to the reduction in the average market interest rate for the past ten years used to measure obligations. The positive development of the fair value of the plan assets had an offsetting effect. Other provisions increased by a total of €83 million, relating mainly to provisions for obligations to employees amounting to €315 million (2020: €171 million) while provisions for unrealized fair value measurement losses on interest rate hedging contracts could be derecognized (2020: €66 million). Liabilities went up by €1,350 million from €7,978 million at the end of the 2020 fiscal year to €9,328 million as of 30 September 2021. The increase resulted from the higher amount of payables to affiliated companies, mainly in connection with intragroup financing management.

At the end of the reporting period, the equity ratio stood at 47.6 percent, compared to 51.4 percent one year earlier.

For information on Infineon's own shares, please see the comments relating to section 160, paragraph 1, no. 2 of the German Stock Corporation Act (AktG) provided in the Separate Financial Statements of Infineon Technologies AG.

<https://www.infineon.com/cms/en/about-infineon/investor/reporting/financial-statements-hgb/>

Dividend

In accordance with the German Stock Corporation Act (AktG), the amount of the dividend available for distribution to shareholders is based on the level of unappropriated profit (Bilanzgewinn) recorded by the ultimate parent, as determined in accordance with the German Commercial Code (HGB).

Infineon Technologies AG reported unappropriated profit of €353 million in its financial statements for the fiscal year ended 30 September 2021. With regard to the 2021 fiscal year, a proposal will be made to pay a dividend of €0.27 per dividend-entitled share out of the unappropriated profit of Infineon Technologies AG, amounting to €353 million. The disbursement of the proposed dividend is subject to approval by the shareholders.

The Company paid a dividend of €0.22 per share (€286 million in total) for the 2020 fiscal year.

For information regarding Infineon's long-term dividend policy, see "Dividend" in the chapter "The Infineon share". [p. 98 ff.](#)

Expected developments, together with associated material risks and opportunities

The expected developments, together with the associated material risks and opportunities of Infineon Technologies AG, are very similar to those of the Group as a whole. Moreover, it is assumed that the result from investments will play a major role in Infineon Technologies AG's earnings performance. As a general rule, Infineon Technologies AG participates in the risks of its subsidiaries and equity investments on the basis of the relevant shareholding. As the parent company, Infineon Technologies AG is integrated into Infineon's overall risk management system and internal control system. For more information on this topic, together with the associated material risks and opportunities of Infineon Technologies AG, see the chapter "Risk and opportunity report". [p. 112 ff.](#)

Most transactions within Infineon involving derivative financial instruments are handled by Infineon Technologies AG. The comments provided in "Principles and structure of Infineon's treasury" within the chapter "Review of liquidity", [p. 107 f.](#), regarding the nature and scope of transactions involving derivative financial instruments and hedged risks also apply to Infineon Technologies AG. Reference is also made to the Notes to the Separate Financial Statements of Infineon Technologies AG.

<https://www.infineon.com/cms/en/about-infineon/investor/reporting/financial-statements-hgb/>

Corporate Governance

Information pursuant to section 289a, paragraph 1, and section 315a, paragraph 1, of the German Commercial Code (HGB)

Structure of the subscribed capital

The share capital of Infineon Technologies AG stood at €2,611,842,274 as of 30 September 2021. This sum is divided into 1,305,921,137 no par value registered shares, each of which represents a notional portion of the share capital of €2 per share. Each share carries one vote and gives an equal right to the profit of the Company based on the profit appropriation resolved by shareholders at the Annual General Meeting.

The Company held 4,545,602 of the above-mentioned issued shares as own shares as of 30 September 2021 (30 September 2020: 5,251,391 shares). Own shares held by the Company on the date of the Annual General Meeting do not carry a vote and are not entitled to participate in profit.

Restrictions on voting rights or the transfer of shares

Restrictions on the voting rights of shares may, in particular, arise as a result of the regulations of the German Stock Corporation Act (Aktiengesetz – "AktG"). For example, pursuant to section 136 AktG shareholders are prohibited from voting under certain circumstances and, pursuant to section 71b AktG, Infineon Technologies AG has no voting rights from its own shares. Furthermore, non-compliance with the notification requirements pursuant to section 33, paragraphs 1 or 2 of the German Securities Trading Act (Wertpapierhandelsgesetz – "WpHG") and to section 38, paragraph 1 as well as section 39, paragraph 1, WpHG can, pursuant to section 44 WpHG, have the effect that certain rights (including the right to vote) may, at least temporarily, not exist. We are not aware of any contractual restrictions on voting rights or the transfer of shares.

Pursuant to section 67, paragraph 2, AktG, rights and obligations arising from shares in relation to Infineon Technologies AG exist only for and from the parties entered in the share register. In order to be recorded in the share register of Infineon Technologies AG, shareholders are required to submit to Infineon Technologies AG the number of shares held by them and their name or company name, their postal and electronic address and, where applicable, their registered office and their date of birth. Pursuant to section 67, paragraph 4, AktG, Infineon Technologies AG is entitled to request information from the party listed in the share register regarding the extent to which shares to which the entry in the share register relates are actually owned by the registered party and, if it does not own the shares, to receive the information necessary for the maintenance of the share register in relation to the party for whom the shares are held. Section 67, paragraph 2, AktG stipulates that the shares concerned do not confer voting rights until such time as the information requested has been supplied in the appropriate manner.

Direct or indirect shareholdings exceeding 10 percent of the voting rights

Section 33, paragraph 1, WpHG requires each shareholder whose voting rights reach, exceed or, after exceeding, fall below 3, 5, 10, 15, 20, 25, 30, 50 or 75 percent of the voting rights of a listed corporation to notify such corporation and the German Federal Financial Supervisory Authority (Bundesanstalt für Finanzdienstleistungsaufsicht – “BaFin”) immediately. As of 30 September 2021, we have not been notified of any direct or indirect shareholdings reaching or exceeding 10 percent of the voting rights. The shareholdings notified to us as of 30 September 2021 are presented in the Notes to the Separate Financial Statements of Infineon Technologies AG under the information pursuant to section 160, paragraph 1, No. 8 AktG.

Shares with special rights that confer control rights

No shares conferring special control rights have been issued.

Nature of control over voting rights when employees participate in the Company’s capital and do not exercise their control rights directly

Employees who participate in the capital of Infineon Technologies AG exercise their control rights directly in accordance with the applicable laws and the Articles of Association, just like other shareholders.

Statutory regulations and Articles of Association provisions governing the appointment and dismissal of members of the Management Board and amendments to the Articles of Association

Section 5, paragraph 1, of the Articles of Association stipulates that the Management Board of Infineon Technologies AG is required to consist of at least two members. With effect from 15 April 2021, the Management Board comprises five members (previously four members). Management Board members are appointed and dismissed by the Supervisory Board pursuant to section 84, paragraph 1, AktG. As Infineon Technologies AG falls within the scope of the German Co-Determination Act (Mitbestimmungsgesetz – “MitbestG”), the appointment or dismissal of Management Board members requires a two-thirds majority of the votes of the Supervisory Board members (section 31, paragraph 2, MitbestG). If the required majority is not achieved at the first ballot, the appointment may be approved on a recommendation of the Mediation Committee at a second ballot by a simple majority of the votes of the Supervisory Board members (section 31, paragraph 3, MitbestG). If the required majority is still not achieved, a third ballot is held in which the Chairman of the Supervisory Board has two votes (section 31, paragraph 4, MitbestG).

If the Management Board does not have the required number of members, in urgent cases, the local court (“Amtsgericht” of Munich) makes the necessary appointment upon petition of a party concerned pursuant to section 85, paragraph 1, AktG.

Pursuant to section 84, paragraph 1, sentence 1, AktG, the maximum term of appointment for Management Board members is five years. Re-appointment or an extension of the term of office, in each case for a maximum of five years, is permitted (section 84, paragraph 1, sentence 2, AktG). Section 5, paragraph 1, of the Articles of Association and section 84, paragraph 2, AktG stipulate that the Supervisory Board may appoint a chairman and a deputy chairman to the Management Board. The Supervisory Board may revoke the appointment of a Management Board member and the Chairman of the Management Board for good cause (section 84, paragraph 3, AktG).

Pursuant to section 179, paragraph 1, AktG, responsibility for amending the Articles of Association rests with the Annual General Meeting. However, section 10, paragraph 4, of the Articles of Association gives the Supervisory Board the authority to amend the Articles of Association insofar as any such amendment relates merely to the

wording, such as changes in the share capital amount resulting from a capital increase out of conditional or authorized capital or a capital decrease by means of cancellation of own shares. Unless the Articles of Association provide for another majority, section 179, paragraph 2, AktG stipulates that resolutions of the Annual General Meeting regarding the amendment of the Articles of Association require a majority of at least three quarters of the share capital represented. Section 17, paragraph 1, of the Articles of Association of Infineon Technologies AG provides in principle for resolutions to be passed with a simple majority of the votes cast and, when a capital majority is required, with a simple majority of the capital unless a higher majority is required by law or in accordance with other stipulations contained in the Articles of Association.

Powers of the Management Board, in particular with respect to the issuing or buying back of shares

The power of the Management Board to issue shares derives from section 4 of the Articles of Association, in conjunction with applicable legal provisions. Further information relating to the Company's existing Authorized and Conditional Capital can be found in note 19 to the Consolidated Financial Statements. [p. 192 f.](#)

Authorization to issue convertible bonds and/or bonds with warrants

The Annual General Meeting held on 20 February 2020 authorized the Management Board, in the period through 19 February 2025, either once or in partial amounts, to issue convertible bonds and/or bonds with warrants (referred to collectively as "bonds") of an aggregate nominal amount of up to €4,000,000,000, to guarantee such bonds issued by subordinated Group companies of the Company and to grant bond creditors and/or bondholders conversion or option rights to up to 130,000,000 no par value registered Company shares, representing a notional portion of the share capital of up to €260,000,000 in accordance with the relevant terms of the bonds. With the approval of the Supervisory Board, the Management Board is authorized to exclude the right of shareholders to subscribe to the bonds

- › if the issue price is not substantially lower than the bonds' theoretical market value as determined in accordance with accepted valuation methods, in particular those based on financial mathematics. However, this right of exclusion only applies insofar as the aggregate value of the shares to be issued to service the conversion or option rights established on this basis does not exceed 10 percent

of the share capital, neither at the time the resolution concerning this authorization was passed by the Annual General Meeting, at the time of this authorization becoming effective, nor at the time it is exercised;

- › in order to exclude fractional amounts resulting from a given subscription ratio from the subscription rights of the shareholders to the bonds, or insofar as any such action is necessary in order to grant holders of conversion or option rights arising from bonds that have already been or will in future be issued by the Company or its subordinated Group companies subscription rights to that extent to which they would be entitled after exercising their rights, or after the fulfillment of any conversion or option obligations; and
- › insofar as bonds are issued in return for a capital contribution in kind, provided that the value of any such capital contribution in kind is appropriate in relation to the market value of the bonds.

Even if the dilution protection regulations are applied, the conversion or option price must equal at least 80 percent of the arithmetic mean of the closing prices of the Company's share in Xetra trading on the Frankfurt Stock Exchange (or comparable successor system). Further details – including the conditions under which the conversion or option price may be reduced – are set out in the authorization.

Subject to the requirements resolved by the shareholders at the Annual General Meeting, the Management Board is authorized to determine the further details of the bond issue, including its terms and conditions.

Authorization to acquire own shares

A resolution passed by the Annual General Meeting on 22 February 2018 authorizes Infineon Technologies AG, in the period through 21 February 2023, to acquire its own shares, within the statutory boundaries, in an aggregate amount not exceeding 10 percent of the share capital at the time the resolution was passed or – if the latter amount is lower – of the share capital in existence at the time the authorization is exercised. The Company may not use the authorization for the purposes of trading in its own shares. The Management Board decides whether own shares are acquired

through the stock exchange, by means of a public offer to purchase addressed to all shareholders, a public invitation to submit offers for sale, or via a bank or other entity that meets the requirements of section 186, paragraph 5 sentence 1, AktG. The authorization includes differentiating requirements – in particular with regard to the permissible purchase price – for each method of acquisition.

Infineon shares acquired or being acquired on the basis of this or an earlier authorization may – if not sold either via the stock exchange or by means of a public offer to purchase addressed to all shareholders – be used for all legally admissible purposes. The shares may also be canceled or offered to third parties in conjunction with business combinations or the acquisition of companies, parts of companies or participations in companies. Subject to the approval of the Supervisory Board, under specified circumstances the shares may also be sold to third parties in return for cash payment (including by means other than through the stock exchange or through an offer to all shareholders), used to meet the Company's obligations under convertible bonds and bonds with warrants and stock option plans, offered for sale or granted as a remuneration component to members of corporate bodies and employees within the Group, and/or used to repay securities-backed loans. The subscription right of shareholders is excluded in all of the above cases (except when the shares are canceled). In addition, the subscription rights of shareholders are excluded in respect of fractional amounts in instances in which the shares are sold through a public offer addressed to all shareholders.

According to a resolution passed by the Annual General Meeting on 22 February 2018, the acquisition of Infineon Technologies AG shares may also be effected using equity derivatives. The total number of shares that can be acquired using derivatives may not exceed 5 percent of the Company's share capital, determined either at the time of this authorization becoming effective or at the time of its exercise through the use of the derivatives. The shares acquired through the exercise of this authorization are to be counted toward the acquisition threshold for the shares acquired in accordance with the authorization to acquire own shares as described above. The authorization stipulates other restrictions when derivatives are deployed, including their execution, term, servicing and acquisition price.

If own shares are acquired using derivatives in accordance with the requirements stipulated in the authorization, any right of the shareholders to conclude such derivative transactions with the Company will be excluded in analogous application of section 186, paragraph 3, sentence 4, AktG. Shareholders have no right to conclude derivative transactions with the Company.

Shareholders have a right to sell their Infineon shares in this connection only insofar as the Company is required to accept the shares under the derivative transactions. No other right to sell shares shall apply in this connection.

The use of own shares acquired through derivatives is governed by the same rules as those applicable for the direct acquisition of own shares.

Significant agreements that are subject to the condition of a change of control as a result of a takeover bid and compensation agreements with Management Board members or employees in the event of a takeover bid

Various financing agreements with lending banks and capital market creditors contain defined change-of-control clauses that give creditors the right to demand early repayment. These clauses reflect standard market practice.

Furthermore, certain patent cross-licensing agreements, development agreements, subsidy agreements and approvals, supply contracts, joint venture agreements and license agreements contain customary change-of-control clauses, which, in the event of a change of control at Infineon Technologies AG, make the continuation of the agreement dependent on the consent of the contracting party, grant special rights to the contracting party that may be unfavorable for Infineon, or even entitle the contracting party to terminate the agreement.

If a Management Board member leaves their position in connection with a defined change of control, that member is entitled to continued payment of the relevant annual remuneration for the entire remaining contract term. In accordance with a special contract termination right granted to Management Board members, the period of continued payment is capped at a maximum of 36 months in the event that the member resigns, or at a minimum of 24 months and a maximum of 36 months in

the event of dismissal/termination of contract by Infineon Technologies AG. All service contracts have since been adapted to the new Management Board remuneration system, so that the maximum period of continued payment has been reduced to 24 months for all Management Board members with effect from 1 October 2021. Further details are contained in the remuneration report.

The change-of-control clauses agreed with Management Board members are intended to provide financial security to those members in the event of a change of control, with a view to preserving their independence in this situation.

The conditions of both the Performance Share Plan and the Restricted Stock Unit Plan, in which Infineon managers and other selected employees worldwide participate, contain rules that are triggered in the event of a defined change of control. For the most part, these rules specify that the vesting periods that are envisaged by the relevant plans are aborted in the event of a change of control. Although Management Board members also participate in the Performance Share Plan, the rules therein relating to a change of control do not apply to Management Board members, given that their service contracts take precedence.

Statement on Corporate Governance pursuant to sections 289f and 315d of the German Commercial Code (HGB)/ Corporate Governance Report

The Statement on Corporate Governance pursuant to sections 289f and 315d of the German Commercial Code (HGB), including the Corporate Governance Report, is publicly available.

www.infineon.com/declaration-on-corporate-governance

Remuneration report

This remuneration report, which forms part of the Combined Management Report, explains the principles of the remuneration system for the Management Board and Supervisory Board of Infineon Technologies AG as well as the level of remuneration paid to the individual Management Board and Supervisory Board members.

In addition to statutory requirements, the remuneration report is based primarily on the German Accounting Standard on Reporting on the Remuneration of Members of Governing Bodies (DRS 17). The remuneration report also contains the model tables recommended by the German Corporate Governance Code (Deutsche Corporate Governance Kodex – “DCGK”) in the version dated 7 February 2017 (DCGK 2017). This information is provided despite the fact that the DCGK was revised with effect from 20 March 2020 and accordingly, the recommendation to disclose the model tables no longer applies. For reasons of consistency and transparency, the model tables are to be continued until the changeover to the new remuneration report stipulated in Section 162 of the German Stock Corporation Act and introduced in accordance with the Act Implementing the Second Shareholder Rights Directive (ARUG II). The new report becomes binding for Infineon Technologies AG for the first time for the fiscal year beginning on 1 October 2021.

Management Board remuneration

Remuneration system

Similar to the remuneration paid to individual Management Board members, the Management Board remuneration system is defined and regularly reviewed by the full Supervisory Board on the basis of recommendations made by the Executive Committee.

On 20 November 2020, the Supervisory Board adopted a new Management Board remuneration system based on the recommendation of the Executive Committee. The new system was approved by the Annual General Meeting on 25 February 2021 in accordance with Section 120a of the German Stock Corporation Act and will apply as a general rule for incumbent Management Board members effective 1 October 2021.

However, the amended rules governing the variable remuneration component relating to the Long-Term Incentive (LTI) have been applied taking into account the grant made on 1 April 2021 (and thus retrospectively from 1 October 2020 for the 2021 fiscal year). The rationale for the early implementation of the new LTI rules was, firstly, that the Performance Share Plan (PSP) for employees, which had been designed as an LTI plan, was amended with effect from 1 April 2021, and it was desirable to synchronize that plan with the Management Board's LTI. Secondly, this procedure obviated the need to grant a further tranche of the variable remuneration component relating to the Mid-Term Incentive (MTI) in the 2021 fiscal year, reflecting the fact that the new remuneration system no longer includes an MTI component, the latter having been incorporated in the LTI with a view to strengthening long-term variable remuneration.

The aforementioned amendments to the Management Board remuneration system, which already apply for the 2021 fiscal year, are described in detail in this remuneration report. The other adjustments, which will only be relevant from the 2022 fiscal year, are outlined hereinafter in "Revision of the Management Board remuneration system", p. 147 ff. They are included in full and in detail in the notice of the Annual General Meeting held on 25 February 2021 and also presented on the website of Infineon.

<https://www.infineon.com/cms/en/about-infineon/investor/corporate-governance/#equity-based-compensation>

Appropriateness of Management Board remuneration

In accordance with applicable legal requirements and the recommendations of the DCGK, the remuneration paid to Management Board members is intended to reflect the typical level and structure of management board remuneration at peer companies, as well as Infineon's economic position and future prospects. The duties, responsibilities and performance of each Management Board member are also to be considered, as is Infineon's wider pay structure. This includes considering Management Board remuneration in relation to that of senior management and the workforce

as a whole, including changes in the level of remuneration over time. The stated objective is that the remuneration structure should be designed in such a way that it promotes sustainable and long-term business development. The level of remuneration should contribute towards achieving Infineon's business strategies, with a cap in place in the event of exceptional developments. Infineon sets remuneration at a level that is competitive both nationally and internationally, with the aim of inspiring and rewarding dedication and success in a dynamic environment.

To ensure appropriateness, the Supervisory Board performs both horizontal and vertical comparisons at regular intervals.

The horizontal view compares the remuneration of Infineon's Management Board members with that of similar companies. In its most recent review of the appropriateness of Management Board remuneration, the Supervisory Board used a peer group of comparable DAX-listed companies (as of 31 December 2019, but excluding Linde plc and Wirecard AG, as no annual reports were available for these companies at the time of the comparison for 2019), comprising the following:

- > Adidas AG
- > Allianz SE
- > BASF SE
- > Bayer AG
- > Beiersdorf AG
- > BMW AG
- > Continental AG
- > Daimler AG
- > Deutsche Bank AG
- > Deutsche Börse AG
- > Deutsche Lufthansa AG
- > E.ON SE
- > Fresenius Medical Care AG & Co. KGaA
- > Fresenius SE & Co. KGaA
- > HeidelbergCement AG
- > Henkel AG & Co. KGaA
- > Merck KGaA
- > MTU Aero Engines AG
- > Münchener Rückversicherungs-Gesellschaft AG
- > RWE AG
- > SAP SE
- > Siemens AG

In addition to the horizontal comparison, a vertical view is also taken, whereby Infineon's internal remuneration structure is assessed by comparing the remuneration of the Management Board with that of senior management (senior executives in Germany and those performing internationally comparable functions) and the workforce as a whole. Apart from the current status, changes in the level of remuneration over time are also considered.

Components of the Management Board remuneration system

As remuneration for their service, all Management Board members receive a target annual income which – based on 100 percent target achievement – comprises approximately 40 percent fixed remuneration and approximately 60 percent variable remuneration components:

- › **Fixed remuneration:** Comprises a contractually agreed basic annual salary that is not linked to performance and paid in twelve equal monthly installments.
- › **Variable (= performance-related) remuneration:** Comprises two components – an annual bonus (short-term incentive – STI) and a long-term variable remuneration component (long-term incentive – LTI).

With the conversion of the current service contracts to the new Management Board remuneration system with effect from 1 October 2021 (i.e., for the 2022 fiscal year) and, in the case of the LTI with effect from 1 October 2020 (i.e., with the grant made on 1 April 2021 for the 2021 fiscal year), the previous multi-year variable bonus (Mid-Term Incentive – MTI) was discontinued. The allocation amount previously awarded for the MTI has now been largely added to the LTI. This change has the effect of increasing the weighting of long-term variable remuneration.

The **short-term incentive (“STI”)** is intended to reward performance over the fiscal year just ending, reflecting Infineon's recent progress. Assuming 100 percent target achievement of the variable remuneration components, the STI constitutes approximately 18 percent of target annual income. It is set by the Supervisory Board in a two-phase process:

- (i) At the beginning of each fiscal year, the target functions with respect to the two key performance indicators Free Cash Flow and Return on Capital Employed (RoCE) are defined uniformly for all Management Board members. Underpinning the consistent approach taken to managing the business, the same target indicators – supplemented by the Segment Result Margin – serve as the basis for determining the variable remuneration components (bonus payments) for Infineon managers and employees. The two key performance indicators referred to above, which are described in more detail in the chapter “Internal Management System”, are equally weighted for the purposes of measuring the STI. [p. 93](#). With the conversion of the current service contracts to the new Management Board remuneration system with effect from 1 October 2021 (i.e., for the 2022 fiscal year) all three performance indicators (Free Cash Flow, Return on Capital Employed and Segment Result Margin) are also relevant for the Executive Board.
- (ii) At the end of the fiscal year, the actual levels of target achievement, and hence the amount of the STI payouts, are determined by the Supervisory Board by reference to the levels of target achievement for Free Cash Flow and RoCE as reported in the audited financial statements.

An STI is paid out only if the levels of target achievement reach at least the 50 percent threshold for both performance indicators (Free Cash Flow and RoCE). If one of the two target thresholds is not achieved, no annual bonus is paid for the relevant fiscal year. If the thresholds are achieved, the arithmetic mean of the two target achievements is calculated and used as the percentage rate to determine the actual amount of the STI. A cap of 250 percent applies, meaning that the maximum amount that can be paid out is two-and-a-half times the target STI (= 100 percent), regardless of an actual higher level of achievement. Moreover, the Supervisory Board may increase or reduce the amount payable in each case by up to 50 percent as it sees fit, based

on the performance of the Management Board as a whole, Infineon's position, and any exceptional factors that may be relevant. A lower limit applies in this case, such that the amount payable may not be less than the amount that would be due given 50 percent target achievement. The upper limit for an upward adjustment is the cap of 250 percent.

If a member's term of office on the Management Board begins or ends during a fiscal year, that member's entitlement to the STI is reduced on a pro rata monthly basis (by one twelfth for each full month missing from the complete STI tranche). A Management Board member is not entitled to receive an STI bonus for the fiscal year in which he/she resigns from office (unless the resignation is for a reason ("good cause") for which the member is not responsible or if the Management Board member's service contract is terminated by the Company for good cause.

With regard to the performance indicator Free Cash Flow for the 2021 fiscal year, the Supervisory Board had set a threshold of €347 million (0 percent target achievement), a target of €770 million (100 percent target achievement) and a maximum of €1,232 million (250 percent target achievement).

Free Cash Flow recorded for the 2021 fiscal year amounts to €1,574 million, corresponding to a target achievement level of 250 percent.

With regard to the performance indicator RoCE for the 2021 fiscal year, the Supervisory Board had set a threshold of 3.0 percent (0 percent target achievement), a target of 9.0 percent (100 percent target achievement) and a maximum of 17.5 percent (250 percent target achievement).

When calculating the RoCE relevant for determining the level of target achievement, those factors which cannot be influenced by the relevant decision-makers are adjusted in the earnings figure (operating profit from continuing operations after taxes). This applies in particular to earnings components which are not directly segment-related. The RoCE determined in this way for the 2021 fiscal year came in at 11.7 percent, corresponding to a target achievement level of 138.5 percent.

If both targets (Free Cash Flow and RoCE) end up with the same weighting, the arithmetic (mean) target achievement level for the 2021 fiscal year is 194.2 percent.

Exceptional factors not covered by the definitions of RoCE and Free Cash Flow that have a (positive or negative) impact on target achievement are taken into account by the Supervisory Board as it sees fit for the purposes of determining the target achievement level, provided that such factors are significant and were not already included in the forecast.

From the 2022 fiscal year onwards, the STI will – alongside the aforementioned financial performance criteria and Segment Result Margin – also include a criteria-based modifier that enables the Supervisory Board to assess the Management Board's collective performance and take appropriate account of extraordinary developments that were not adequately reflected in the targets set at an earlier stage. After the end of the respective fiscal year, the Supervisory Board applies a factor of between 0.7 and 1.3 to determine the overall level of target achievement. The collective performance of the Management Board rewards the extent to which the Management Board contributes to the sustainable development of the Company as a whole – in strategic, technical or structural terms. Prior to the beginning of each fiscal year, the Supervisory Board selects the criteria that it has determined are relevant for the fiscal year in question, based on the following categories:

- › sustainable strategic, technical or structural development of the business;
- › portfolio-related measures, particularly successful mergers and acquisitions as well as corresponding integration measures;
- › successful development of new growth markets, improvement of market position;
- › optimizations, efficiency improvement programs, restructuring;
- › successful completion of key projects;
- › improved innovative strength and delivery capabilities;
- › progress in Environmental, Social & Governance (ESG) matters.

For the 2022 fiscal year, the Supervisory Board has defined two specific criteria at the recommendation of the Executive Committee:

- › Firstly, the performance of the Management Board should be measured in terms of its implementation of the digital transformation strategy.
- › Secondly, the development of key technologies and innovations and, in this context, the corresponding market growth for SiC and GaN products, which is strategically vital for Infineon.

The **Mid-Term Incentive (“MTI”)** was intended to reward sustained performance by the Management Board that reflected Infineon’s medium-term progress. As explained above, the MTI has been discontinued as a remuneration component with effect from 1 October 2020. In concrete terms, this means that no new three-year MTI tranches have been granted since 1 October 2020, i.e., for the 2021 fiscal year. The two MTI tranches allocated for the 2019 and 2020 fiscal years continued to be valid but will not be supplemented with additional annual tranches. Accordingly, after the end of the 2021 fiscal year, the tranche allocated for the 2019 fiscal year was paid out in two annual installments (for the 2019 and 2020 fiscal years). After the end of the 2022 fiscal year, the tranche allocated for the 2020 fiscal year will be paid out with only one annual tranche (for the 2020 fiscal year). The Supervisory Board may increase or reduce the amount to be paid under the MTI in each case by up to 50 percent as it sees fit, based on the performance of the Management Board as a whole, Infineon’s position and any exceptional factors.

As the previous MTI allocation amount has now been added to the LTI with a four-year performance period, a temporary payout shortfall arises, which will be compensated by temporarily increasing the STI allocation amount for the Management Board members concerned in the 2022, 2023 and 2024 fiscal years. Therefore, a maximum remuneration of €8,200,000 (Chief Executive Officer) and €4,800,000 (ordinary member of the Executive Board) applies to current service contracts for fiscal years 2022, 2023 and 2024.

The **Long-Term Incentive (“LTI”)** was adjusted with retrospective effect from 1 October 2020.

The LTI is a Performance Share Plan with a four-year performance period. Assuming 100 percent target achievement of the variable remuneration components, the LTI constitutes approximately 42 percent of target annual income.

The performance period begins on 1 October of the first fiscal year of the performance period and ends on 30 September four years later. During this period, performance is measured on the basis of two criteria, namely a financial performance criterion based on relative Total Shareholder Return (TSR) as compared to a selected sector peer group and a non-financial performance criterion derived from strategic Environmental, Social & Governance (ESG) targets. The TSR and the ESG targets contribute 80 percent and 20 percent to overall target achievement respectively.

The LTI tranche is allocated on 1 April in the first fiscal year of the performance period (allocation date). The vesting period begins on the allocation date. Unlike the performance period, the vesting period ends four years after the allocation date, i.e., on 31 March. In order to determine the number of performance shares to be provisionally awarded on the allocation date, at the beginning of the performance period, the individual allocation amount is divided by the average share price over the last 60 trading days prior to the beginning of the performance period. The extent of target achievement is determined at the end of the four-year performance period. The definitive number of performance shares to be allocated after the end of the vesting period is calculated by multiplying the number of provisionally allocated performance shares by the total target achievement of the two performance criteria applied during the performance period. The definitive allocation of performance shares in an LTI tranche may not result in the Management Board member’s gain (before taxes) exceeding 250 percent of the respective LTI allocation amount. Above this cap, any performance shares that could still theoretically be allocated will lapse.

If the service contract of a Management Board member begins and/or ends during the fiscal year, the LTI grant amount for the fiscal year shall be reduced pro rata temporis on a monthly basis (by one twelfth for each missing full month).

Performance criteria and measuring success

TSR

The TSR is defined as Infineon's share price performance over the performance period, including any dividends per share paid during that period (cumulative and notionally reinvested) compared to a pre-defined peer group. The TSR measures the total shareholder return, reflects the overall success of an investment, and is used as an indicator to determine the increase in market or company value. Target achievement for the TSR is based on a comparison with Infineon's main international competitors (sector peer group):

- › Analog Devices Inc.
- › Broadcom Inc.
- › China Electronics Huada Technology Company Ltd.
- › Dialog Semiconductor PLC ¹
- › Elmos Semiconductor SE
- › Fuji Electric CO., LTD.
- › GigaDevice Semiconductor (Beijing) Inc.
- › Knowles Corp.
- › Macronix International Co., Ltd.
- › MediaTek Inc.
- › Microchip Technology Inc.
- › Micron Technology, Inc.
- › Mitsubishi Electric Corp.
- › Nuvoton Technology Corp.
- › NXP Semiconductors N.V.
- › Omron Corp.
- › ON Semiconductor Corp.
- › Power Integrations Inc.
- › Qualcomm Technologies, Inc.
- › Renesas Electronics Corp.
- › Rohm CO., LTD.
- › Shanghai Fudan Microelectronics Group Co., Ltd.
- › Silicon Laboratories, Inc.
- › STMicroelectronics N.V.
- › Texas Instruments Inc.
- › Toshiba Corp.
- › Vishay Intertechnology, Inc.
- › Winbond Electronics Corp.
- › Wolfspeed, Inc.

¹ Dialog Semiconductor PLC was acquired by Renesas Electronics Corporation in August 2021.

Only companies that exist (and remain) as a legally independent entity throughout the performance period are considered part of the peer group. The Supervisory Board may adjust the peer group as it sees fit prior to the beginning of a new performance period.

The target achievement for Infineon's TSR performance criterion is determined using the ranking method. In this context, the TSR is calculated for Infineon and all companies in the sector peer group and ranked according to size. This ranking results in a percentile rank that indicates where Infineon's TSR is positioned.

The TSR target achievement can range between 0 percent and 150 percent. If Infineon's TSR is positioned at the 60th percentile, the target achievement is 100 percent. A position at or below the 25th percentile results in a target achievement of 0 percent, while a position at or above the 75th percentile results in a target achievement of 150 percent. Target achievements between the defined target achievement points are interpolated linearly. The TSR includes all cash dividends paid out during the performance period by all companies in the peer group (including Infineon) and is calculated as follows:

$$\text{TSR} = \frac{\text{(Change in Stock Price + Dividends Paid)}}{\text{Beginning Stock Price}}$$

ESG

ESG targets are defined as non-financial, quantitative and qualitative performance criteria relating to environmental, social and governance (ESG) matters. These include, for example, contributions to global climate protection (such as carbon neutrality by 2030) or the furthering of diversity at Infineon that has a positive impact on innovation, employee commitment and financial performance. Establishing a clear link between ESG targets and Infineon's business and sustainability strategies, on the one hand, and current market requirements, on the other, creates incentives for managing the company on a sustainable basis in the best interest of stakeholders. The ESG targets

are therefore important in that they align the interests of both the Management Board and other stakeholders and contribute to the long-term sustainable success of the Group as a whole.

The specific ESG targets to be used for a particular tranche are determined and definitively resolved by the Supervisory Board prior to the beginning of the performance period. The Supervisory Board defines up to three specific ESG targets, which are weighted equally. At the end of the performance period, target achievement is determined on the basis of a target/actual comparison and, as in the case of the LTI financial performance criterion, can range between 0 percent and 150 percent. The specific ESG targets, target achievement curves and target achievements are disclosed ex post in the remuneration report. The Supervisory Board is entitled to determine further ESG targets and their relative weightings.

For the LTI tranche allocated on 1 April 2021, the Supervisory Board has defined two ESG targets: one relating to environment and the other to social matters.

The environmental target is to achieve 50 percent carbon neutrality in the 2024 fiscal year. The base period for these purposes is the 2019 calendar year. The target is to be achieved by reducing PFC emissions, energy efficiency measures or development assistance measures linked to decarbonization. The aim is to achieve a total reduction of 100,000 tons of carbon emissions by the end of the 2024 fiscal year. Target achievement can range between 0 percent and 150 percent. If carbon emissions are reduced by less than 25,000 tons, target achievement is 0 percent. If carbon emis-

sions are reduced by 100,000 tons, target achievement is 100 percent. If they are reduced by 150,000 tons or more, target achievement is 150 percent. Target achievements between the defined target achievement points are interpolated linearly. If carbon neutrality is not achieved, the target achievement is 0 percent regardless of the aforementioned linear component. The environmental target contributes 10 percent to the overall target achievement of the LTI.

The Supervisory Board has also defined a further ESG target in the area of social matters. In the light of this diversity target, gender diversity is taken into account, i.e., the proportion of women in management positions as well as other diversity factors. A target range has been defined for the percentage of women in management positions.

The aim is to increase the percentage of women in GG (Global Grade) 13+ positions to within a target range between 18 percent and 20 percent by the 2030 fiscal year. Target achievement for the diversity target can range between 0 percent and 150 percent. A 100 percent target achievement corresponds to an increase of between 1.2 percentage points and 1.8 percentage points at the end of the performance period. The baseline is 15.2 percent as of 30 September 2020. If the proportion of women is increased by up to 0.3 percentage points during the performance period, this results in a target achievement of 0 percent, while an increase in the proportion of women by more than 2.3 percentage points would result in a target achievement of 150 percent. Target achievements between the defined target achievement points are interpolated linearly. The diversity target contributes 10 percent to the overall target achievement of the LTI.

C41 Diversity target

Diversity

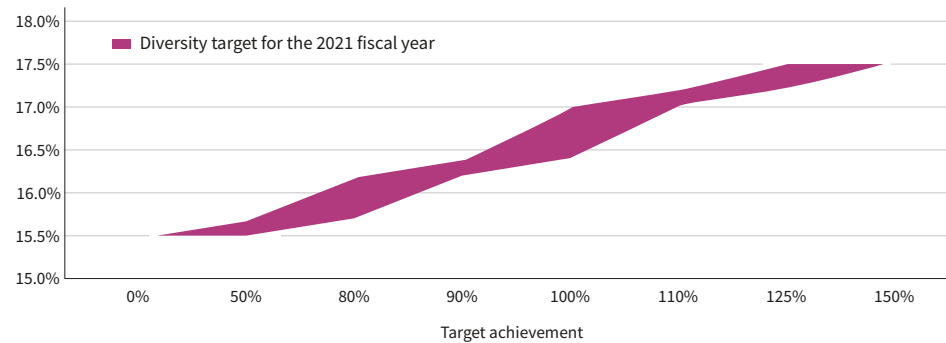
**Final allocation**

After the final fiscal year of the four-year performance period has ended, the Supervisory Board determines the number of performance shares that will be definitively allocated. The Supervisory Board reserves the right to make a cash settlement rather than actually transferring Infineon shares. The Supervisory Board is required to make the decision prior to the end of the four-year vesting period; otherwise the right to make a cash settlement lapses. If the Supervisory Board decides to settle in cash, the amount to be paid out is calculated by multiplying the number of performance shares definitively allocated by the average share price over the last 60 trading days prior to the end of the four-year performance period. Payment must be made within one month after the end of the vesting period. Here too, the definitive LTI payout amount is limited to 250 percent of the individual allocation amount.

LTI rules prior to the changeover to the new remuneration system

The LTI tranches already allocated prior to the changeover to the new remuneration system will continue to be subject to the old rules described below.

The (virtual) performance shares were allocated as of 1 March for the fiscal year that began on 1 October, initially on a provisional basis. The final allocation and transfer of (real) Infineon shares took place four years later. Performance shares were allocated provisionally on the basis of the contractually agreed “LTI allocation amount” in euros and agreed upon individually in the service contract of each Management Board member. The number of performance shares was determined by dividing the LTI allocation amount by the average price of the Infineon share (Xetra closing price) during the nine months prior to the allocation date. The prerequisites for the definitive allocation of the – at that stage still virtual – performance shares are (i) that the Management Board member invests 25 percent of his/her individual LTI allocation amount in Infineon shares and (ii) that the holding period of four years applicable both for the member’s own investment and for the performance shares has come to an end. 50 percent of the performance shares are also performance-related; they are only allocated definitively if (iii) the Infineon share outperforms the Philadelphia Semiconductor Index (SOX) between the date of the performance shares’ provisional allocation and the end of the holding period. If the conditions for the definitive allocation of performance shares – either all or only those that are not performance-related – are met at the end of the holding period, the Management Board member acquires an entitlement against the Company for the transfer of the corresponding number of (real) Infineon shares. Any performance shares that do not achieve the target are forfeited. The value of the performance shares definitively granted to the Management Board member per LTI tranche at the end of the holding period may not exceed 250 percent of the relevant LTI allocation amount; any performance shares above this amount lapse (cap).

Based on its own best judgment, the Supervisory Board has the option to grant a special bonus, such as for exceptional achievements of the Management Board or its individual members. In each case, however, the bonus is capped at a maximum of 30 percent of the fixed remuneration of the Management Board member concerned. Under the new Management Board remuneration system, the option to grant a special bonus has been removed without replacement.

Management Board remuneration in the 2021 fiscal year in accordance with German Accounting Standard 17 (DRS 17)

Total remuneration

Total remuneration to Management Board members in accordance with DRS 17 and benefits to individual Management Board members – also presented in accordance with DRS 17 – are shown in the table below.

Management Board members did not receive any loans from Infineon or benefits from third parties in the 2021 and 2020 fiscal years, whether promised or actually paid, for their board activities at Infineon.

Fringe benefits

In accordance with their service contracts, Management Board members are entitled to a chauffeur-driven company car, which may also be used for private purposes. Operating and maintenance costs for the company car and chauffeur are borne by the Company. Any taxes arising on the fringe benefit related to private usage are borne by the individual Management Board members themselves.

The Company also maintains accident insurance policies for Management Board members in the case of death (€3 million) and invalidity (€5 million).

in €	Dr. Reinhard Ploss Chief Executive Officer		Dr. Sven Schneider Chief Financial Officer		Dr. Helmut Gassel Management Board member		Jochen Hanebeck Management Board member		Constanze Hufenbecher Management Board member since 15 April 2021 ³		Total Management Board	
	2021	2020	2021	2020	2021	2020	2021	2020	2021	2020	2021	2020
Fixed remuneration												
Basic annual salary	1,240,000	1,240,000	825,000	825,000	750,000	750,000	750,000	750,000	346,591	–	3,911,591	3,565,000
Fringe benefits	35,238	37,211	55,337	55,750	32,188	70,893	28,329	34,476	34,140	–	185,232	198,330
Total fixed remuneration	1,275,238	1,277,211	880,337	880,750	782,188	820,893	778,329	784,476	380,731	–	4,096,823	3,763,330
Variable remuneration												
Single-year variable remuneration (STI)	1,068,100	477,950	728,250	325,875	660,280	295,460	660,280	295,460	302,628	–	3,419,538	1,394,745
Multi-year variable remuneration												
Mid-Term Incentive (MTI) ¹												
2020 – 2022 tranche	–	159,317	–	108,625	–	98,487	–	98,487	–	–	–	464,916
2019 – 2021 tranche	–	159,317	–	108,625	–	98,487	–	98,487	–	–	–	464,916
2018 – 2020 tranche	–	159,317	–	–	–	98,487	–	98,487	–	–	–	356,291
Long-Term Incentive (LTI)												
Performance Share Plan ²	1,767,364	290,050	976,672	264,125	976,672	165,725	976,672	165,725	447,629	–	5,145,009	885,625
Total variable remuneration	2,835,464	1,245,951	1,704,922	807,250	1,636,952	756,646	1,636,952	756,646	750,257	–	8,564,547	3,566,493
Total remuneration	4,110,702	2,523,162	2,585,259	1,688,000	2,419,140	1,577,539	2,415,281	1,541,122	1,130,988	–	12,661,370	7,329,823

¹ The values include the annual MTI tranche granted in the respective fiscal year based on the fulfillment of the plan requirements.

² The figures for the active Management Board members in the 2021 fiscal year were based on a fair market value per performance share amounting to €28.87 (2020: €12.50), which was calculated using a Monte Carlo simulation model.

³ Ms. Hufenbecher is entitled to one twenty-fourth of the individual STI or LTI grant amount for the month of April 2021, and thus to a total of 11 twenty-fourths for the entry fiscal year.

The fringe benefits of Ms. Hufenbecher include a one-time lump sum of €25,000 for the reimbursement of start-up costs.

Other fringe benefits relate mainly to statutory obligations such as the payment of inventor's remuneration or general benefits available to all Infineon employees.

Share-based payment

As described in the section "Management Board remuneration", the contractually agreed LTI is granted to Management Board members by Infineon in the form of performance shares, [p. 136](#). The average price of the Infineon share relevant for the number of performance shares granted for the 2021 fiscal year was €22.82 (2020: €18.10).

A fair market value of €28.87 (2020: €12.50) per performance share granted in the 2021 fiscal year was determined, taking account of the cap of 250 percent cap set on the LTI allocation amount as well as the performance hurdle.

The following table shows the number of performance shares awarded to Management Board members in the 2021 fiscal year.

Further details regarding the LTI tranche that vested on 1 October 2021 and the performance shares awarded to Management Board members on 1 April 2021 for the 2021 fiscal year are provided in note 21 to the Consolidated Financial Statements. [p. 195 f.](#)

		Performance Share Plan						
		Virtual performance shares outstanding at the beginning of the fiscal year	Virtual performance shares newly granted in the fiscal year	Fair value grant date in €	Virtual performance shares due in the fiscal year ¹	Virtual performance shares expired in the fiscal year ²	Virtual performance shares outstanding at the end of the fiscal year	Total expense for share-based payment in €
Management Board member	Fiscal year	Number	Number		Number	Number	Number	
Dr. Reinhard Ploss Chief Executive Officer	2021	91,788	61,218	1,767,364	14,027	14,027	124,952	523,916
	2020	103,148	23,204	290,050	17,282	17,282	91,788	182,577
Dr. Sven Schneider Chief Financial Officer	2021	21,130	33,830	976,672	-	-	54,960	276,840
	2020	-	21,130	264,125	-	-	21,130	59,802
Dr. Helmut Gassel Management Board member	2021	53,328	33,830	976,672	8,455	8,455	70,248	291,991
	2020	40,070	13,258	165,725	-	-	53,328	104,328
Jochen Hanebeck Management Board member	2021	53,328	33,830	976,672	8,455	8,455	70,248	291,991
	2020	40,070	13,258	165,725	-	-	53,328	104,328
Constanze Hufenbecher Management Board member since 15 April 2021 ³	2021	-	15,505	447,629	-	-	15,505	99,473
	2020	-	-	-	-	-	-	-
Total	2021	219,574	178,213	5,145,009	30,937	30,937	335,913	1,484,211
	2020	183,288	70,850	885,625	17,282	17,282	219,574	451,035

¹ The share price of the virtual performance shares exercised on 1st October 2020 amounted to €25.50.

² In the 2021 and 2020 fiscal years, virtual performance shares expired because the performance hurdle had not been met.

³ Despite taking office on 15th April 2021, Ms. Hufenbecher was granted virtual performance shares retroactively as of 1st April 2021. Ms. Hufenbecher is entitled to one twenty-fourth of the individual LTI grant amount for the month of April 2021, and thus to a total of 11 twenty-fourths for the entry fiscal year.

Special bonuses

The Supervisory Board did not award any special bonuses to Management Board members during the 2021 fiscal year.

Other awards and benefits

In the 2009 fiscal year, the Company entered into a restitution agreement with each of the then active Management Board members. Dr. Ploss is the only current Management Board member affected by the agreement. The agreements stipulate that the Company covers all costs and expenses of any legal, governmental, regulatory and/or parliamentary proceedings and investigations as well as arbitration proceedings in which Management Board members are involved in conjunction with their activities on behalf of the Company. However, the agreements specifically exclude any restitution of costs incurred in conjunction with section 93, paragraph 2, AktG.

Remuneration of the Management Board in the 2021 fiscal year in accordance with DCGK 2017 (voluntary disclosure)

Remuneration granted (“gewährte Zuwendungen”)

The following table shows the value of remuneration granted for the 2020 and 2021 fiscal years, including fringe benefits, as well as the minimum and maximum values that can be achieved for the 2021 fiscal year.

Unlike the disclosures in accordance with DRS 17, the STI is disclosed in the following table at the target value (i.e., the value in the event of 100 percent target achievement). In a deviation from DRS 17, the MTI was disclosed at the target value for an “average probability scenario” at the grant date. For these purposes, Infineon assumes 100 percent target achievement on a scale ranging from 0 percent to 200 percent. In addition, the pension expense, i.e., the service cost in accordance with IAS 19 (see “Commitments to Management Board members upon termination of their Board activities” in this chapter, [p. 145 f.](#)), is included in total remuneration.

in €	Dr. Reinhard Ploss Chief Executive Officer				Dr. Sven Schneider Chief Financial Officer				Dr. Helmut Gassel Management Board member			
	2021	2020	2021 (min.)	2021 (max.)	2021	2020	2021 (min.)	2021 (max.)	2021	2020	2021 (min.)	2021 (max.)
Fixed remuneration												
Basic annual salary	1,240,000	1,240,000	1,240,000	1,240,000	825,000	825,000	825,000	825,000	750,000	750,000	750,000	750,000
Fringe benefits	35,238	37,211	35,238	35,238	55,337	55,750	55,337	55,337	32,188	70,893	32,188	32,188
Total fixed remuneration	1,275,238	1,277,211	1,275,238	1,275,238	880,337	880,750	880,337	880,337	782,188	820,893	782,188	782,188
Variable remuneration												
Single-year variable remuneration (STI)	550,000	550,000	-	1,375,000	375,000	375,000	-	937,500	340,000	340,000	-	850,000
Multi-year variable remuneration												
Mid-Term Incentive (MTI)												
2020 – 2022 tranche	-	550,000	-	-	-	375,000	-	-	-	340,000	-	-
Long-Term Incentive (LTI)												
Performance Share Plan ¹	1,767,364	290,050	-	3,492,500	976,672	264,125	-	1,930,000	976,672	165,725	-	1,930,000
Total variable remuneration	2,317,364	1,390,050	-	4,867,500	1,351,672	1,014,125	-	2,867,500	1,316,672	845,725	-	2,780,000
Pension expense	72,298	368,802	72,298	72,298	278,244	294,037	278,244	278,244	98,884	106,961	98,884	98,884
Total remuneration (DCGK)	3,664,900	3,036,063	1,347,536	6,215,036	2,510,253	2,188,912	1,158,581	4,026,081	2,197,744	1,773,579	881,072	3,661,072

¹ The figures of the active Management Board members in the 2021 fiscal year were based on a fair market value per performance share amounting to €28.87 (2020: €12.50), which was calculated using a Monte Carlo simulation.

in €	Jochen Hanebeck Management Board member				Constanze Hufenbecher Management Board member since 15 April 2021 ²			
	2021	2020	2021 (min.)	2021 (max.)	2021	2020	2021 (min.)	2021 (max.)
Fixed remuneration								
Basic annual salary	750,000	750,000	750,000	750,000	346,591	-	346,591	346,591
Fringe benefits	28,329	34,476	28,329	28,329	34,140	-	34,140	34,140
Total fixed remuneration	778,329	784,476	778,329	778,329	380,731	-	380,731	380,731
Variable remuneration								
Single-year variable remuneration (STI)	340,000	340,000	-	850,000	155,833	-	-	389,583
Multi-year variable remuneration								
Mid-Term Incentive (MTI)								
2020 – 2022 tranche	-	340,000	-	-	-	-	-	-
Long-Term Incentive (LTI)								
Performance Share Plan ¹	976,672	165,725	-	1,930,000	447,629	-	-	884,583
Total variable remuneration	1,316,672	845,725	-	2,780,000	603,462	-	-	1,274,166
Pension expense	120,148	129,139	120,148	120,148	131,044	-	131,044	131,044
Total remuneration (DCGK)	2,215,149	1,759,340	898,477	3,678,477	1,115,237	-	511,775	1,785,941

1 The figures of the active Management Board members in the 2021 fiscal year were based on a fair market value per performance share amounting to €28.87 (2020: €12.50), which was calculated using a Monte Carlo simulation.

2 Ms. Hufenbecher is entitled to one twenty-fourth of the individual STI or LTI grant amount for the month of April 2021, and thus to a total of 11 twenty-fourths for the entry fiscal year.

Remuneration received by Management members (“Zufluss”)

Since the remuneration granted to Management Board members for the 2021 fiscal year did not coincide fully with amounts disbursed in a particular fiscal year, a separate table is presented below showing the amounts flowing to (i.e., received by) Management Board members for the 2021 fiscal year (“Zufluss”).

Accordingly, the fixed remuneration and the STI are disclosed as amounts received by Management Board members for the relevant fiscal year. The MTI was disclosed as received by Management Board members in the fiscal year in which the plan term of the relevant MTI tranche ends. However, due to the discontinuation of the MTI, the

tranche allocated for the 2019 fiscal year was paid and included two annual installments (for the 2019 and 2020 fiscal years). In addition to the fixed remuneration and the STI granted for the 2021 fiscal year, the Management Board members therefore received the 2019-2021 MTI tranche, reduced by the amount of the tranche for the 2021 fiscal year. Share-based payments are disclosed as received by Management Board members on the basis of the relevant time and value for German tax law purposes. The amount disclosed as received for the pension expense (i.e., the service cost in accordance with IAS 19) corresponds to the amounts granted (see previous table), even though it does not strictly constitute an actual receipt.

The total remuneration received by individual members of the Management Board for the 2021 fiscal year – analyzed by component – is shown in the following table:

in €	Dr. Reinhard Ploss Chief Executive Officer		Dr. Sven Schneider Chief Financial Officer		Dr. Helmut Gassel Management Board member		Jochen Hanebeck Management Board member		Constanze Hufenbecher Management Board member since 15 April 2021 ¹	
	2021	2020	2021	2020	2021	2020	2021	2020	2021	2020
Fixed remuneration										
Basic annual salary	1,240,000	1,240,000	825,000	825,000	750,000	750,000	750,000	750,000	346,591	-
Fringe benefits	35,238	37,211	55,337	55,750	32,188	70,893	28,329	34,476	34,140	-
Total fixed remuneration	1,275,238	1,277,211	880,337	880,750	782,188	820,893	778,329	784,476	380,731	-
Variable remuneration										
Single-year variable remuneration (STI)	1,068,100	477,950	728,250	325,875	660,280	295,460	660,280	295,460	302,628	-
Multi-year variable remuneration										
Mid-Term Incentive (MTI)										
2019 – 2021 tranche	323,400	-	156,188	-	199,920	-	199,920	-	-	-
2018 – 2020 tranche	-	533,500	-	-	-	329,800	-	329,800	-	-
Long-Term Incentive (LTI)										
Performance Share Plan										
due in the 2021 fiscal year	357,656	-	-	-	215,583	-	215,583	-	-	-
due in the 2020 fiscal year	-	270,905	-	-	-	-	-	-	-	-
Total variable remuneration	1,749,156	1,282,355	884,438	325,875	1,075,783	625,260	1,075,783	625,260	302,628	-
Pension expense	72,298	368,802	278,244	294,037	98,884	106,961	120,148	129,139	131,044	-
Total remuneration (DCGK)	3,096,692	2,928,368	2,043,019	1,500,662	1,956,855	1,553,114	1,974,260	1,538,875	814,403	-

1 Ms. Hufenbecher is entitled to one twenty-fourth of the individual STI or LTI grant amount for the month of April 2021, and thus to a total of 11 twenty-fourths for the entry fiscal year.

Commitments to Management Board members upon termination of their Board activities

Benefits and pension entitlements in the 2021 fiscal year

Based on the amendment to the Executive Board compensation system in 2010, all Management Board members have received a defined contribution pension commitment that is essentially identical to the Infineon pension plan applicable to all employees. Accordingly, the Company has set up a personal pension account (basic account) for each beneficiary, to which it makes annual pension contributions. The Company adds annual interest to the balance in the basic account using the highest statutory interest rates valid for the insurance industry (guaranteed interest rates) until disbursement of the pension begins and may also award surplus credits. 95 percent of any income earned over and above the guaranteed interest rate is credited to the pension account, either at the date on which disbursement of the pension begins or, at the latest, when the beneficiary reaches the age of 60. The balance of the basic account when disbursement of the pension begins (due to age, invalidity or death) – increased by an adjusting amount in the event of invalidity or death – constitutes the retirement benefit entitlement and is paid out to the Management Board member or his or her surviving dependents in twelve annual installments, or, if so requested by the Management Board member, in eight annual installments, as a lump sum, or as a life-long pension. In addition to the defined contribution pension plan that has been in place for Dr. Ploss since 1 January 2016, a fully vested fixed-amount pension entitlement of €210,000 p.a. also exists for his Board activities up to 31 December 2015, which will not increase in the future.

If the entitlements of Management Board members (i) have not yet legally vested or (ii) have legally vested but are not protected by the state pension insurance scheme (Pensionssicherungsverein), the Company maintains pension reinsurance policies in favor of, and pledged to, the Management Board members concerned.

The plan rules applicable to Management Board members are as follows:

- › Dr. Gassel and Mr. Hanebeck have statutorily vested pension entitlements as a result of their previous periods of employment in senior management positions with Infineon. Their service contracts specifically state that the amounts made available to cover their vested pension entitlements represent a continuation of those vested entitlements and are, therefore, not subject to any separate vesting arrangements. The Company makes a fixed annual pension contribution on behalf of Dr. Gassel and Mr. Hanebeck for each full fiscal year of service on the Management Board, equivalent to 30 percent of the relevant agreed basic annual salary. The Supervisory Board is not required to decide each time on the amount to be contributed. The pension contributions for the 2021 fiscal year for Dr. Gassel and Mr. Hanebeck amounted to €225,000 in each case.
- › The pension contribution made for Ms. Hufenbecher also amounts to 30 percent of the relevant agreed basic annual salary. Due to the entry during the fiscal year, the pension contribution made by the Company for the 2021 fiscal year amounted to €112,500.
- › The defined contribution pension commitment in place for Dr. Ploss is also based on a fixed contribution amount of 30 percent of the relevant agreed basic annual salary. The pension contribution made by the Company for the 2021 fiscal year amounted to €372,000.
- › The corresponding contribution for Dr. Schneider also amounts to 30 percent of the relevant agreed basic annual salary. The pension contribution made by the Company for the 2021 fiscal year amounted to €247,500.

The amounts credited to the pension entitlement accounts of Management Board members – in line with the plan rules applied to Infineon employees – are paid out on or after reaching the age of 67, provided the service contract arrangements have also ended. Upon request, amounts can also be paid out at an earlier point in time if the service contract arrangements end on or after reaching the age of 60 or, in the case of

commitments made from 2012 onwards, on or after reaching the age of 62. If the beneficiaries elect to have their pension paid out in monthly installments, the pension amount is adjusted automatically each year in accordance with the Infineon pension plan.

Alongside the annual retirement entitlements and related benefit amounts, the following table shows the present values of pension entitlements earned to date and the service cost in accordance with IFRS. The present value of pension and benefit entitlements is particularly dependent on changes in the discount rate that is required to be applied (30 September 2021: 1.25 percent; 30 September 2020: 0.95 percent).

Pension entitlements

	Fiscal year	Pension entitlements (annual) as of beginning of pension period	Benefit amounts determined for the relevant fiscal year	Present value of pension and benefit entitlement	Original service cost (earned in the current year)
in €					
Dr. Reinhard Ploss ¹ Chief Executive Officer	2021	-	372,000	2,290,395	72,298
		210,000	-	5,114,761	-
	2020	-	372,000	2,474,927	368,802
		210,000	-	5,279,415	-
Dr. Sven Schneider Chief Financial Officer	2021	-	247,500	554,907	278,244
	2020	-	247,500	393,029	294,037
Dr. Helmut Gassel Management Board member	2021	-	225,000	2,414,767	98,884
	2020	-	225,000	2,653,885	106,961
Jochen Hanebeck Management Board member	2021	-	225,000	2,995,017	120,148
	2020	-	225,000	3,279,840	129,139
Constanze Hufenbecher ² Management Board member since 15 April 2021	2021	-	112,500	131,044	131,044
	2020	-	-	-	-
Total	2021	210,000	1,182,000	13,500,891	700,618
	2020	210,000	1,069,500	14,081,096	898,939

1 The upper line for Dr. Ploss in the 2021 fiscal year respectively 2020 shows the contribution amount, the present value and the service cost relating to the defined contribution pension commitment additionally granted to him with effect from 1 January 2016. The second line in the 2021 fiscal year respectively 2020 shows the pension entitlement and the present value of his fixed-amount pension plan.

2 The service cost for Ms. Hufenbecher takes into account that she was appointed to the Management Board during the year on 15 April 2021, and therefore was not in the office for the entire 2021 fiscal year.

Premature termination of the service contract

The service contracts of Management Board members include a change-of-control clause, which stipulates the terms that apply when the activities of a Management Board member are terminated in the event of a significant change in Infineon's ownership structure. A change of control for the purposes of this clause occurs when a third party, individually or together with another party, acquires at least 50 percent of the voting rights in Infineon Technologies AG as defined in section 30 of the German Securities Acquisition and Takeover Act (Wertpapiererwerbs- und Übernahmegesetz – "WpÜG"). Management Board members have the right to resign and terminate their service contracts within twelve months of the announcement of any such change of control and any who choose to do so are entitled to continued payment of their annual remuneration through to the end of the originally agreed duration of their contract for a maximum of 36 months. If Infineon Technologies AG removes a Management Board member or terminates their service contract within twelve months of the announcement of a change of control, the Management Board members concerned are entitled to continued payment of their annual remuneration through to the end of the originally agreed duration of their contract, subject to a minimum period of 24 months and a maximum period of 36 months.

The Management Board service contracts otherwise contain no promises of severance pay for situations in which contracts are prematurely terminated.

Under the new Management Board remuneration system, the maximum period of continued payment of fixed and variable remuneration is reduced to 24 months in any case. The service contracts of the incumbent Management Board members were adjusted accordingly with effect from 1 October 2021. For Ms. Hufenbecher, on the other hand, the new regulations have already applied since she took office.

Payments to former Management Board members in the 2021 fiscal year

Total remuneration (primarily pension benefits) of €2,609,306.24 (2020: €2,211,263.52) was paid to former Management Board members in the 2021 fiscal year. As of 30 September 2021, accrued pension liabilities for former Management Board members amounted €72,369,256 (2020: €76,593,563).

Revision of the Management Board remuneration system

The Act Implementing the Second Shareholder Rights Directive (ARUG II) came into force on 1 January 2020. Furthermore, the Government Commission on the German Corporate Governance Code adopted a new version of the DCGK, which became effective on 20 March 2020. The Supervisory Board deliberated on this matter at length with the support of an external independent remuneration expert. Based on the preparatory work of the Executive Committee and its recommendation, the Supervisory Board adopted a new Management Board remuneration system at its meeting on 20 November 2020, which was approved by the Annual General Meeting on 25 February 2021 in accordance with section 120a, AktG.

In addition to the changes already relevant for the 2021 fiscal year and described above (i.e., the incorporation of the MTI into the LTI and the new LTI rule), the remaining parts of the new Management Board remuneration system for the incumbent Management Board members apply from 1 October 2021. The main additional changes can be summarized as follows:

- › The option of the Supervisory Board to award a “special bonus” amounting to up to 30 percent of the fixed basic remuneration of Management Board members has been removed without replacement.
- › In the case of the STI, the existing financial targets RoCE and Free Cash Flow will be supplemented by the addition of a third target, namely the Segment Result Margin (SRM), which already serves as a key performance indicator for Infineon. The SRM was also previously taken into account in the STI target structure applicable to employees.
- › The option of the Supervisory Board to reduce or increase the STI payout amounts by up to 30 percent at its discretion has been replaced by a criteria-based STI modifier. Accordingly, the Supervisory Board defines criteria for assessing the collective performance of the Management Board each fiscal year on the basis of a fixed catalog (see also above in the section “Components of the Management Board remuneration system”, [p. 134 ff.](#)). After the end of the fiscal year, the Supervisory Board can then reduce or increase the target achievement level for the STI by up to 30 percent – depending on the performance of the Management Board and also to take account of any exceptional, unforeseeable developments.
- › The Management Board remuneration system now includes Share Ownership Guidelines that require Management Board members to build up a minimum holding of Infineon shares over a period of generally five years and to hold them for up to two years after leaving office. This minimum holding has been set at the equivalent to 150 percent of the fixed basic annual salary for the Chairman and at 100 percent of the basic annual salary for other Management Board members.
- › As a final point, a malus and clawback clause has been introduced that allows the Supervisory Board to withhold or reclaim variable remuneration components in certain cases.

The structure of the new Management Board remuneration system can be summarized as follows:

Overview of the various components of the remuneration system

Fixed remuneration	
Basic annual salary	Fixed, non-performance-related remuneration paid in twelve equal monthly installments
Fringe benefits	Primarily a company car with chauffeur (also for private use) and an allowance for health and nursing care insurance as well as various insurance and general employee benefits
Company pension plan	Defined contribution plan that provides an annual pension contribution and capital market-oriented interest
Variable (i.e., performance-related) remuneration	
Short-Term Incentive (STI)	
Performance criteria	<ul style="list-style-type: none"> › 1/3 Return on Capital Employed (RoCE) as planned › 1/3 Free Cash Flow (FCF) as planned › 1/3 Segment Result Margin (SRM) as planned
Modifier (0.7 to 1.3)	<ul style="list-style-type: none"> › Collective performance of the Management Board › Extraordinary developments
Performance period	One year
Limitation/cap	250% of the allocation amount
Payment	In cash, after performance period ends
Long-Term Incentive (LTI)	
Plan type	Performance Share Plan
Performance criteria	<ul style="list-style-type: none"> › 80% relative Total Shareholder Return (TSR) › 20% ESG targets
Performance period	Four years
Waiting period	Four years
Limitation/cap	250% of the allocation amount
Payment	Generally in shares, after waiting period expires

Other contractual elements	
Malus and clawback	Partial or complete reduction or reclamation of variable remuneration components
Share Ownership Guidelines (SOG)	
Chairman of the Management Board (CEO)	150% of gross annual basic salary
Full member of the Board	100% of gross annual basic salary
Accumulation phase	Generally five years
Maximum remuneration	
Chairman of the Management Board (CEO)	€7,200,000
Full member of the Board	€4,200,000
Change-of-control clause	In the event of a change of control, right of extraordinary termination within limited period of time and with restricted severance pay regulation

A detailed presentation of the new Management Board remuneration system is available in the notice of the Annual General Meeting held on 25 February 2021 and on the Infineon website. <https://www.infineon.com/cms/en/about-infineon/investor/corporate-governance/#equity-based-compensation>

Supervisory Board remuneration

On 25 February 2021, the Annual General Meeting resolved amendments to the Articles of Association regarding Supervisory Board remuneration and approved the Supervisory Board remuneration system in accordance with Section 113, AktG. The amendments apply with effect from 1 October 2021. A brief summary of these amendments is provided below. The complete wording of the amendments is available in the notice of the Annual General Meeting held on 25 February 2021 and on the Infineon website. <https://www.infineon.com/cms/en/about-infineon/investor/corporate-governance/#equity-based-compensation>

Remuneration structure

The remuneration of the members of the Supervisory Board (total remuneration) is governed by section 11 of the Company's Articles of Association and comprises the following:

- › A **fixed remuneration (basic remuneration)** of €90,000. This amount applies to each Supervisory Board member and is payable within one month of the end of each fiscal year.
- › **Allowances** in recognition of additional work involved in performing certain functions within the Supervisory Board: The Chairman of the Supervisory Board receives an allowance of €90,000, each deputy receives an allowance of €30,000, the Chairman of the Investment, Finance and Audit Committee and the Chairman of the Strategy and Technology Committee each receive an allowance of €25,000, and each member of a Supervisory Board committee receives an allowance of €15,000 – with the exception of the Nomination Committee and the Mediation Committee. The additional allowance is payable only if the body to which the Supervisory Board or committee member belongs has convened or passed resolutions in the fiscal year concerned. A Supervisory Board member performing more than one of the functions indicated receives only the highest single additional allowance payable to a member performing the functions concerned. The allowance is payable to the relevant holder of office within one month of the end of each fiscal year.
- › A **meeting attendance fee** of €2,000 per meeting of the Supervisory Board or one of its committees that is attended in person. The meeting attendance fee is paid only once if more than one meeting of the relevant committees takes place on a given day.

In the event that a member, during a fiscal year, joins (or leaves) the Supervisory Board or one of its committees, or takes on a Supervisory Board function for which an allowance is payable, the relevant remuneration components are disbursed on a pro rata basis, i.e., payment of one twelfth of the relevant annual remuneration component for each (started) month of membership or exercise of function.

Moreover, Supervisory Board members are reimbursed for all expenses incurred in connection with the performance of their Supervisory Board duties as well as for any value-added tax payable by them in this connection. The Company also pays Supervisory Board members any value-added tax incurred on their total remuneration (including meeting attendance fees).

Review of the Supervisory Board remuneration system

In light of the changes brought about by ARUG II, Section 113, paragraph 3, AktG also required the Supervisory Board remuneration system to be submitted for approval at the Annual General Meeting. The Management Board and Supervisory Board came to the conclusion that the current Supervisory Board remuneration system is no longer in line with the market in some respects and therefore proposed changes at the Annual General Meeting held on 25 February 2021, which were adopted accordingly. The main changes compared with the current Supervisory Board remuneration system are as follows:

- › Whereas the fixed basic remuneration and the function-based allowances for the Chairman of the Supervisory Board were increased only slightly, the function-based allowances for the committees and the Chairs of the Investment, Finance and Audit Committee and the Strategy and Technology Committee were raised more significantly to a level in line with the market.
- › The previous threshold clause, according to which only the highest function-based allowance is paid if more than one function is performed, was deleted. The rationale for the change is that working on several committees involves an additional time commitment, which should be remunerated accordingly. Conversely, the payment of a function-based allowance solely on the condition that at least three committee meetings have taken place during a fiscal year ensures that only relevant additional time commitments are remunerated. In addition, the function-based allowances for work on committees are capped at 100 percent of the fixed basic remuneration. As a result, the remuneration for a Supervisory Board member will in the future be limited to €200,000, that of the Chair of the Supervisory Board to €300,000 and that of his/her deputy to €230,000.
- › Furthermore, the attendance fee for extraordinary meetings held in the form of telephone or video conference calls was reduced from €2,000 to €1,000.

Remuneration of the Supervisory Board for the 2021 fiscal year

The total remuneration paid to Supervisory Board members for the 2021 fiscal year (including meeting attendance fees) is presented below. The amounts disclosed do not take into account value-added tax at 19 percent or – in the case of Supervisory Board members resident abroad – withholding tax, solidarity surcharges or any other taxes arising:

Supervisory Board member, in €	Fiscal year	Fixed remuneration	Allowance for specific functions	Meeting attendance fees	Total remuneration
Peter Bauer ¹	2021	–	–	–	–
	2020	37,500	10,417	6,000	53,917
Xiaoqun Clever ^{2,3}	2021	90,000	15,000	18,000	123,000
	2020	60,000	10,000	8,000	78,000
Johann Dechant	2021	90,000	30,000	36,000	156,000
	2020	90,000	30,000	38,000	158,000
Dr. Herbert Diess ¹	2021	–	–	–	–
	2020	37,500	–	4,000	41,500
Dr. Wolfgang Eder ³	2021	90,000	90,000	42,000	222,000
	2020	90,000	90,000	30,000	210,000
Dr. Friedrich Eichiner ^{2,3}	2021	90,000	25,000	22,000	137,000
	2020	60,000	16,667	8,000	84,667
Annette Engelfried	2021	90,000	15,000	30,000	135,000
	2020	90,000	15,000	30,000	135,000
Peter Gruber	2021	90,000	15,000	18,000	123,000
	2020	90,000	15,000	22,000	127,000
Gerhard Hobbach ¹	2021	–	–	–	–
	2020	37,500	6,250	6,000	49,750
Hans-Ulrich Holdenried ³	2021	90,000	15,000	30,000	135,000
	2020	90,000	15,000	22,000	127,000
Prof. Dr. Renate Köcher ¹	2021	–	–	–	–
	2020	37,500	–	4,000	41,500

Supervisory Board member, in €	Fiscal year	Fixed remuneration	Allowance for specific functions	Meeting attendance fees	Total remuneration
Dr. Susanne Lachenmann	2021	90,000	15,000	18,000	123,000
	2020	90,000	15,000	20,000	125,000
Géraldine Picaud ³	2021	90,000	–	12,000	102,000
	2020	90,000	–	10,000	100,000
Dr. Manfred Puffer ³	2021	90,000	–	12,000	102,000
	2020	90,000	–	18,000	108,000
Melanie Riedl ²	2021	90,000	–	12,000	102,000
	2020	60,000	–	16,000	76,000
Jürgen Scholz	2021	90,000	15,000	14,000	119,000
	2020	90,000	15,000	22,000	127,000
Kerstin Schulzendorf	2021	90,000	–	12,000	102,000
	2020	90,000	–	16,000	106,000
Dr. Ulrich Spiesshofer ^{2,3}	2021	90,000	25,000	18,000	133,000
	2020	60,000	16,667	8,000	84,667
Margret Suckale ^{2,3}	2021	90,000	2,500	26,000	118,500
	2020	60,000	–	10,000	70,000
Dr. Eckart Süner ¹	2021	–	–	–	–
	2020	37,500	10,417	8,000	55,917
Diana Vitale	2021	90,000	15,000	30,000	135,000
	2020	90,000	10,000	28,000	128,000
Total	2021	1,440,000	277,500	350,000	2,067,500
	2020	1,477,500	275,418	334,000	2,086,918

1. Joined as Supervisory Board member until 20 February 2020. The remuneration for the 2020 fiscal year therefore was awarded on a pro rata basis.

2. Joined as Supervisory Board member since 20 February 2020. The remuneration for the 2020 fiscal year therefore was awarded on a pro rata basis.

3. The shareholder representatives on the Supervisory Board have waived their entitlement to attendance fees for certain meetings. The Company will donate the attendance fee saved to a charitable institution.

Supervisory Board members did not receive any loans from Infineon in either the 2021 or 2020 fiscal year.

List of references

- | | | | | |
|---|--|---------------------------|------------------------------|--------------------------|
| <p>R01 Based on or includes research from Omdia: <i>Annual 2001 – 2020 Semiconductor Market Share Competitive Landscaping Tool – Q2 2021</i>. August 2021.</p> <p>R02 Strategy Analytics: <i>Automotive Semiconductor Vendor Market Shares</i>. April 2021.</p> <p>R03 Based on or includes research from Omdia: <i>Power Semiconductor Market Share Database 2020</i>. September 2021.</p> <p>R04 Based on or includes research from Omdia: <i>MEMS Microphones Dice Market Shares 2021</i>. July 2021.</p> <p>R05 ABI Research: <i>Smart Card and Embedded Security IC Technologies</i>. September 2021.</p> <p>R06 Based on or includes content supplied by IHS Markit, Automotive Group: <i>Alternative Propulsion Forecast</i>. August 2021; Strategy Analytics: <i>Automotive Semiconductor Demand Forecast 2019 – 2028</i>. July 2021; Infineon.¹</p> <p>R07 Strategy Analytics: <i>Automated Driving Semiconductor Market Estimate</i>. August 2021; Infineon.¹</p> <p>R08 World Semiconductor Trade Statistics (WSTS): <i>Semiconductor Industry Blue Book History</i>. October 2021.</p> <p>R09 Based on or includes research from Omdia: <i>Application Market Forecast Tool Q3 2021 Update</i>. September 2021.</p> <p>R10 Based on or includes research from Omdia: <i>OEM Semiconductor Spend Tracker – World + Regions – H1 2021</i>. August 2021.</p> <p>R11 International Monetary Fund: <i>World Economic Outlook</i>. October 2021.</p> | <p>Neubiberg, 25 November 2021</p> <p>Management Board</p> | <p>Dr. Reinhard Ploss</p> | <p>Dr. Sven Schneider</p> | <p>Dr. Helmut Gassel</p> |
| | | <p>Jochen Hanebeck</p> | <p>Constanze Hufenbecher</p> | |

¹ Not part of the audited combined Management Report.



Consolidated Financial Statements

- 153 Consolidated Statement of Profit or Loss
- 153 Consolidated Statement of Comprehensive Income
- 154 Consolidated Statement of Financial Position
- 155 Consolidated Statement of Cash Flows
- 156 Consolidated Statement of Changes in Equity
- 158 Notes to the Consolidated Financial Statements

Consolidated Statement of Profit or Loss

€ in millions	Notes	2021	2020
Revenue	3	11,060	8,567
Cost of goods sold	3	(6,800)	(5,791)
Gross profit		4,260	2,776
Research and development expenses	3	(1,448)	(1,113)
Selling, general and administrative expenses	3	(1,354)	(1,042)
Other operating income		64	76
Other operating expenses		(52)	(116)
Operating profit		1,470	581
Financial income	3	22	29
Financial expenses	3	(182)	(177)
Share of profit (loss) of associates and joint ventures accounted for using the equity method	4	9	(9)
Profit (loss) from continuing operations before income taxes		1,319	424
Income tax	5	(144)	(52)
Profit (loss) from continuing operations		1,175	372
Profit (loss) from discontinued operations, net of income taxes	6	(6)	(4)
Profit (loss) for the period		1,169	368
Attributable to:			
Shareholders and hybrid capital investors of Infineon Technologies AG		1,169	368
Basic earnings per share (in euro) attributable to shareholders of Infineon Technologies AG: ¹			
Basic earnings per share (in euro) from continuing operations	7	0.88	0.26
Basic earnings (loss) per share (in euro) from discontinued operations	7	(0.01)	-
Basic earnings per share (in euro)	7	0.87	0.26
Diluted earnings per share (in euro) attributable to shareholders of Infineon Technologies AG: ¹			
Diluted earnings per share (in euro) from continuing operations	7	0.88	0.26
Diluted earnings (loss) per share (in euro) from discontinued operations	7	(0.01)	-
Diluted earnings per share (in euro)	7	0.87	0.26

1 The calculation of earnings per share is based on unrounded figures.

Consolidated Statement of Comprehensive Income

€ in millions	Notes	2021	2020
	19		
Profit (loss) for the period		1,169	368
Actuarial gains (losses) on pensions and similar commitments		128	21
Total items that will not be reclassified subsequently to profit or loss		128	21
Foreign currency translation differences		90	(543)
Net change in fair value of hedging instruments		64	(213)
Cost of hedging		-	42
Total items that may be reclassified subsequently to profit or loss		154	(714)
Other comprehensive income (loss), net of tax		282	(693)
Total comprehensive income (loss), net of tax		1,451	(325)
Attributable to:			
Shareholders and hybrid capital investors of Infineon Technologies AG		1,451	(325)

Consolidated Statement of Financial Position

€ in millions	Notes	30 September 2021	30 September 2020
ASSETS			
Cash and cash equivalents		1,749	1,851
Financial investments	8	2,173	1,376
Trade receivables	9	1,483	1,196
Inventories	10	2,181	2,052
Current income tax receivables	5	57	77
Contract assets		82	97
Other current assets	11	518	530
Assets classified as held for sale		9	-
Total current assets		8,252	7,179
Property, plant and equipment	12	4,443	4,110
Goodwill	13	5,962	5,897
Other intangible assets	12	3,349	3,621
Right-of-use assets	14	336	286
Investments accounted for using the equity method	4	71	87
Non-current income tax receivables	5	1	1
Deferred tax assets	5	695	627
Other non-current assets	26	225	191
Total non-current assets		15,082	14,820
Total assets		23,334	21,999

€ in millions	Notes	30 September 2021	30 September 2020
LIABILITIES AND EQUITY			
Short-term financial debt and current portion of long-term financial debt	15	833	505
Trade payables		1,569	1,160
Current provisions	16	815	436
Current income tax payables	5	288	340
Current leasing liabilities	14	66	59
Other current liabilities	17	872	950
Total current liabilities		4,443	3,450
Long-term financial debt	15	5,752	6,528
Pensions and similar commitments	18	617	739
Deferred tax liabilities	5	324	293
Other non-current provisions	16	319	313
Non-current leasing liabilities	14	265	235
Other non-current liabilities	26	213	222
Total non-current liabilities		7,490	8,330
Total liabilities		11,933	11,780
Equity:	19		
Ordinary share capital		2,612	2,612
Additional paid-in capital		6,513	6,462
Retained earnings		1,407	435
Other reserves		(306)	(460)
Own shares		(28)	(33)
Hybrid capital		1,203	1,203
Total equity		11,401	10,219
Total liabilities and equity		23,334	21,999

Consolidated Statement of Cash Flows

€ in millions	Notes	2021	2020	€ in millions	Notes	2021	2020
	25						
Profit (loss) for the period		1,169	368	Purchases of financial investments	8	(4,275)	(6,045)
Plus: profit (loss) from discontinued operations, net of income taxes		6	4	Proceeds from sales of financial investments	8	3,480	7,417
Adjustments to reconcile profit (loss) for the period to net cash provided by operating activities:				Acquisitions of businesses, net of cash acquired		(19)	(7,433)
Depreciation and amortization	12	1,513	1,260	Proceeds from sales of businesses and interests in subsidiaries, net of cash disbursed		13	(1)
Income tax	5	144	52	Investments in related companies		-	(44)
Net interest result	3	150	101	Purchases of other intangible assets and other assets	12	(229)	(184)
Gains on disposals of property, plant and equipment		(5)	(22)	Purchases of property, plant and equipment	12	(1,268)	(915)
Dividends received	4	4	2	Proceeds from sales of property, plant and equipment and other assets		14	33
Impairment charges/reversals of impairments	12, 13, 28	12	12	Net cash used in investing activities from continuing operations		(2,284)	(7,172)
Other non-cash result		5	56	Net cash used in investing activities from discontinued operations		-	-
Change in trade receivables	9	(279)	46	Net cash used in investing activities		(2,284)	(7,172)
Change in inventories	10	(121)	124	Net change in related party financial receivables and payables	24	2	-
Change in trade payables		407	(71)	Proceeds from issuance of long-term financial debt	15	1,084	9,815
Change in provisions	16	372	65	Repayments of long-term financial debt	15	(1,570)	(5,372)
Change in other assets and other liabilities		11	-	Payments for leasing liabilities	14	(76)	(63)
Interest received	3	3	17	Deposits for financing-related derivatives	3	-	25
Interest paid	3	(148)	(129)	Proceeds from issuance of ordinary shares	19	-	1,043
Income tax paid	5	(180)	(68)	Cash outflows due to changes of non-controlling interests		-	(2)
Net cash provided by operating activities from continuing operations		3,063	1,817	Dividend payments	19	(286)	(336)
Net cash provided by (used in) operating activities from discontinued operations		2	(6)	Proceeds from hybrid capital	19	-	1,184
Net cash provided by operating activities		3,065	1,811	Cash outflow to hybrid capital investors	19	(39)	(20)
				Net cash provided by (used in) financing activities from continuing operations		(885)	6,274
				Net cash provided by (used in) financing activities from discontinued operations		-	-
				Net cash provided by (used in) financing activities		(885)	6,274
				Net change in cash and cash equivalents		(104)	913
				Effect of foreign exchange rate changes on cash and cash equivalents		2	(83)
				Cash and cash equivalents at beginning of period		1,851	1,021
				Cash and cash equivalents at end of period		1,749	1,851

Consolidated Statement of Changes in Equity

for the fiscal year ended 30 September 2020

	Notes	Share capital	Capital reserves	Retained earnings	Other reserves			Own shares	Equity attributable to shareholders of Infineon Technologies AG	Equity attributable to hybrid capital investors	Total equity
					Foreign currency translation differences	Hedges	Cost of hedging				
€ in millions											
Balance as of 1 October 2019		2,501	5,494	421	144	152	(42)	(37)	8,633	-	8,633
Total comprehensive income (loss), net of tax											
Profit (loss) for the period		-	-	329	-	-	-	-	329	39	368
Other comprehensive income (loss), net of tax		-	-	21	(543)	(213)	42	-	(693)	-	(693)
Total comprehensive income (loss), net of tax		-	-	350	(543)	(213)	42	-	(364)	39	(325)
Transactions with owners											
Contributions by and distributions to owners											
Capital increase	19	110	934	-	-	-	-	-	1,044	-	1,044
Dividends	19	-	-	(336)	-	-	-	-	(336)	-	(336)
Share-based payment	21	-	11	-	-	-	-	-	11	-	11
Exercise of stock options	19	1	1	-	-	-	-	-	2	-	2
Disposal (purchase) of own shares	19	-	-	-	-	-	-	4	4	-	4
Other contributions and distributions	19	-	22	-	-	-	-	-	22	-	22
Total contributions by and distributions to owners		111	968	(336)	-	-	-	4	747	-	747
Total transactions with owners		111	968	(336)	-	-	-	4	747	-	747
Transactions with hybrid capital investors											
Emission hybrid capital	19	-	-	-	-	-	-	-	-	1,184	1,184
Compensations to hybrid capital investors	19	-	-	-	-	-	-	-	-	(20)	(20)
Total transactions with hybrid capital investors		-	-	-	-	-	-	-	-	1,164	1,164
Balance as of 30 September 2020		2,612	6,462	435	(399)	(61)	-	(33)	9,016	1,203	10,219

Consolidated Statement of Changes in Equity

for the fiscal year ended 30 September 2021

	Notes	Share capital	Capital reserves	Retained earnings	Other reserves			Own shares	Equity attributable to shareholders of Infineon Technologies AG	Equity attributable to hybrid capital investors	Total equity
					Foreign currency translation differences	Hedges	Cost of hedging				
€ in millions											
Balance as of 1 October 2020		2,612	6,462	435	(399)	(61)	-	(33)	9,016	1,203	10,219
Total comprehensive income (loss), net of tax											
Profit (loss) for the period		-	-	1,130	-	-	-	-	1,130	39	1,169
Other comprehensive income (loss), net of tax		-	-	128	90	64	-	-	282	-	282
Total comprehensive income (loss), net of tax		-	-	1,258	90	64	-	-	1,412	39	1,451
Transactions with owners											
Contributions by and distributions to owners											
Dividends	19	-	-	(286)	-	-	-	-	(286)	-	(286)
Share-based payment	21	-	24	-	-	-	-	-	24	-	24
Disposal (purchase) of own shares	19	-	-	-	-	-	-	5	5	-	5
Other contributions and distributions	19	-	27	-	-	-	-	-	27	-	27
Total contributions by and distributions to owners		-	51	(286)	-	-	-	5	(230)	-	(230)
Total transactions with owners		-	51	(286)	-	-	-	5	(230)	-	(230)
Transactions with hybrid capital investors											
Compensations to hybrid capital investors	19	-	-	-	-	-	-	-	-	(39)	(39)
Total transactions with hybrid capital investors		-	-	-	-	-	-	-	-	(39)	(39)
Balance as of 30 September 2021		2,612	6,513	1,407	(309)	3	-	(28)	10,198	1,203	11,401

Notes to the Consolidated Financial Statements

The Infineon Group (“Infineon”), comprising Infineon Technologies AG (hereafter also referred to as “the Company”) and its direct and indirect subsidiaries, design, develop, manufacture and market a broad range of semiconductors and related system solutions. The focus of activities is on applications for automotive electronics, industrial electronics, entertainment and household electronics, information and communications infrastructure as well as hardware-based security. The product range includes standard, application-specific and customer-specific components as well as system solutions for power, digital, analog, high frequency and mixed-signal applications. Research and development sites, manufacturing facilities, investments and customers are located mainly in Europe, Asia and North America.

Infineon Technologies AG is a listed company under German law and the ultimate parent company of Infineon. The principal office of the Company is Am Campeon 1 – 15, 85579 Neubiberg (Germany). The Company is registered in the Commercial Register of the District Court of Munich (Germany) under the number HRB 126492.

1 Basis of the Consolidated Financial Statements

The Consolidated Financial Statements, prepared by Infineon Technologies AG as the ultimate parent company for the year ended 30 September 2021, have been prepared in accordance with International Financial Reporting Standards (“IFRS”) and related interpretations effective as of 30 September 2021 as issued by the International Accounting Standards Board (“IASB”) to the extent to which the IFRS and interpretations have been endorsed by the European Union (“EU”). The Consolidated Financial Statements also comply with the supplementary requirements set out in section 315e, paragraph 1, of the German Commercial Code (“Handelsgesetzbuch” or “HGB”). The aforementioned standards were complied with in full.

The Consolidated Statement of Profit or Loss is presented using the cost of sales method.

The fiscal year-end for both Infineon and the Company is 30 September of each year.

The Group’s reporting currency is the euro (“€”).

Deviations between amounts presented are possible due to rounding. Negative amounts are presented in parentheses.

The Company’s Management Board presented the Consolidated Financial Statements on 25 November 2021.

Financial reporting rules applied for the first time

The IASB has issued the following Standards or amendments to Standards, which are required to be applied in the Consolidated Financial Statements for the year ended 30 September 2021:

Standard/amendment/interpretation	Effective date	Impact on Infineon
IAS 1 and IAS 8 Definition of material (amendments to IAS 1 and IAS 8)	1 January 2020	none
IFRS 3 Definition of a business (amendments to IFRS 3)	1 January 2020	none
IFRS 16 COVID-19-related rent concessions (amendment to IFRS 16)	1 June 2020	immaterial
Interest rate benchmark reform (amendments to IFRS 9, IAS 39 and IFRS 7) – Phase 1	1 January 2020	none
Revision to the conceptual framework and amendments to references to the conceptual framework in IFRS Standards	1 January 2020	none

Financial reporting rules issued not yet applied

The following new or amended Standards have been issued by the IASB and will be relevant to Infineon from today's perspective. They have not been applied in the Consolidated Financial Statements as of 30 September 2021 since they are not yet mandatory or, alternatively, have not yet been endorsed by the EU. The new or amended Standards are applicable for fiscal years beginning on or after their respective effective date. As a general rule, they are not applied before their effective date, even if this is permitted for certain Standards.

Standard/amendment/interpretation	Effective date	Impact on Infineon
IAS 16 Property, plant and equipment – income before intended use (amendments to IAS 16)	1 January 2022	none
IAS 1 Classification of liabilities as current or non-current (amendments to IAS 1)	1 January 2023	none
IFRS 3 References to the conceptual framework	1 January 2022	none
IAS 37 Onerous contracts – costs of fulfilling a contract (amendments to IAS 37)	1 January 2022	immaterial
IFRS 17 Insurance contracts including amendments to IFRS 17	1 January 2023	none
IFRS 4 Extension to the temporary exemption from applying IFRS 9 (amendments to IFRS 4)	1 January 2021	none
Interest rate benchmark reform (amendments to IFRS 9, IAS 39, IFRS 7, IFRS 4 and IFRS 16) – Phase 2	1 January 2021	none
Annual IFRS improvement cycle 2018 – 2020	1 January 2022	none
IAS 12 Deferred tax relating to assets and liabilities arising from a single transaction (amendments to IAS 12)	1 January 2023	none
IAS 1 Disclosure of accounting policies (amendments to IAS 1 and IFRS Practice Statement 2)	1 January 2023	immaterial
IAS 8 Definition of accounting estimates (amendments to IAS 8)	1 January 2023	none
IFRS 16 Rent concessions related to the Coronavirus pandemic (amendment to IFRS 16) – extension	1 April 2021	immaterial

2 Summary of significant accounting policies

Basis of consolidation

The Consolidated Financial Statements presented here include the individual financial statements of Infineon Technologies AG and its direct and indirect subsidiaries on a consolidated basis. A subsidiary is defined as an entity which, directly or indirectly, is controlled by Infineon Technologies AG.

Control exists when Infineon is subjected to variable returns arising from its engagement with the subsidiary or has a right to such, and has the ability to influence these returns as a result of its power over the subsidiary. Power means that Infineon has existing rights that give Infineon the ability to direct the relevant activities of the subsidiary, that is the activities that significantly affect the aforementioned returns.

An entity is included in the Consolidated Financial Statements from the date on which Infineon acquires control. Upon first-time consolidation of an entity, the acquired assets and assumed liabilities are basically measured on the basis of their fair value at the acquisition date. Any excess of consideration paid (purchase price) over the share of the fair value of acquired assets, liabilities and contingent liabilities is recognized as goodwill. After re-examination, any excess of Infineon's share of the fair value of items acquired over consideration paid is recognized as a gain.

The financial statements of entities included in the Consolidated Financial Statements are prepared using uniform valuation and accounting policies.

The balance sheet effects of intragroup transactions as well as gains and losses arising from intragroup business relationships are eliminated on consolidation.

A list of subsidiaries of Infineon Technologies AG is provided in note 29. [p. 225 ff.](#)

In the absence of control over an entity, but the entity is a joint venture or an associated company, these are included in the consolidated financial statements using the equity method (see note 4, [p. 173](#)). Where objective indications of impairment in the carrying amount of an equity-based investment are present, an impairment test is carried out. If the carrying amount exceeds the recoverable amount, an impairment loss is recognized in financial expenses.

Functional currency and foreign currency translation

The functional currency of Infineon Technologies AG is the euro.

Foreign currency transactions of subsidiaries are translated into the functional currency of the relevant entity using the spot rate prevailing at the transaction date. Monetary foreign currency assets and liabilities are translated at the spot rate prevailing at the reporting date. Exchange rate gains and losses from the translation of foreign currency transactions are recognized in the Consolidated Statement of Profit or Loss.

The assets and liabilities of subsidiaries with functional currencies other than the euro are translated into euros using the spot rate at the end of the reporting period. Income and expenses of these entities are translated using the average spot rate of the reporting period. All currency translation differences resulting from the consolidation are recognized directly in equity and presented as “Other reserves”.

Recognition and measurement principles

The following table summarizes the main measurement principles used in the preparation of the Consolidated Financial Statements:

Balance sheet item	Measurement principle
ASSETS	
Cash and cash equivalents	Fair value/amortized cost
Financial investments	Fair value/amortized cost
Trade receivables	Unconditional right to consideration/amortized cost
Inventories	Lower of acquisition or production cost and net realizable value
Contract assets	Right to consideration/impairment in accordance with IFRS 9
Property, plant and equipment	Amortized acquisition or production cost
Goodwill	Impairment-only approach
Other intangible assets	Amortized acquisition or production cost
Right-of-use assets	Amortized acquisition cost
Other assets (current and non-current):	
Other financial assets:	
At amortized cost	Fair value/amortized cost
At fair value through profit or loss	Fair value through profit or loss
Designated hedging instruments	Fair value through other comprehensive income
Remaining other assets	Amortized cost

Balance sheet item	Measurement principle
LIABILITIES AND EQUITY	
Financial debt (short-term and long-term)	Fair value/amortized cost
Trade payables	Fair value/amortized cost
Provisions:	
Pensions	Projected unit credit method
Other provisions (current and non-current)	Expected settlement amount
Leasing liabilities (current and non-current)	Amortized present value of outstanding lease payments
Other liabilities (current and non-current):	
Other financial liabilities:	
Measured at fair value through profit or loss	Fair value through profit or loss
Designated hedging instruments	Fair value through other comprehensive income
Other financial liabilities	Fair value/amortized cost
Remaining other liabilities	Fair value/amortized cost
Own shares	Acquisition cost
Hybrid bonds	Acquisition cost

Cash and cash equivalents

Cash and cash equivalents represent cash and all financial resources with a maturity at acquisition date of three months or less. Cash equivalents partly include investments in money market funds. The valuation is recorded at amortized acquisition cost or at fair value through profit or loss.

Financial instruments

Financial instruments are initially recognized at their fair value. Transaction costs directly attributable to the acquisition or issuance of financial instruments are only included in the carrying amount if the financial instruments are not measured at fair value through profit or loss.

Trade receivables are recognized based on the amount to which Infineon has an unconditional right to receive. With the exception of matters which result in a partial

refund of the purchase price to the customer, this corresponds to the transaction price determined in accordance with IFRS 15. The subsequent measurement of trade receivables is carried out at amortized cost.

Purchases and sales of financial assets are recognized on the settlement date.

Financial assets are derecognized when the rights to receive payments from the investments have expired or have been transferred and Infineon has transferred all risks and rewards associated with ownership. Financial liabilities are derecognized when they are extinguished, that is when the contractual obligation is discharged, canceled or expired.

Financial assets

> Classification and measurement of financial assets

Upon initial recognition, financial assets are classified for subsequent measurement either as at amortized cost, fair value through other comprehensive income or fair value through profit or loss. This classification depends on the characteristics of the contractual cash flows of the financial assets and Infineon's business model for managing its financial assets.

Infineon's business model for managing financial asset portfolios reflects how the Company controls its financial assets in order to generate cash flows. Depending on the business model, cash flows arise from the receipt of contractual cash flows, the sale of financial assets or both.

In order for a financial asset in the form of a debt instrument to be classified and measured at amortized cost or at fair value through other comprehensive income, cash flows may only arise from the repayment of principal and interest payments on the outstanding principal amount. This assessment is referred to as a cash flow or SPPI test ("solely payments of principal and interest") and is carried out at the level of the individual financial instrument.

On this basis, Infineon's financial asset measurement categories are as follows:

Financial assets measured at amortized cost include all assets whose contractual provisions result in cash flows at fixed times that represent only interest and principal repayments of the outstanding principal amount, provided that those assets are held with the intention of collecting the contractual cash flows expected over their respective duration. In subsequent periods, financial assets measured at amortized cost are measured using the effective interest method. Interest income, currency gains and losses, impairments, and gains or losses from the derecognition of such financial assets are recognized through profit or loss.

At the reporting date, Infineon did not hold any financial assets with the intention to collect contractual cash flows and also to sell them. Therefore, there was no allocation of financial assets in the form of debt instruments to the category "fair value through other comprehensive income".

Financial assets in the form of debt instruments that are measured at fair value through profit or loss include all financial assets at Infineon whose cash flows are not exclusively interest payments and principal repayments.

At Infineon, financial assets in the form of equity instruments are consistently measured at fair value through profit or loss.

Net gains and losses, including interest and dividend income, from financial assets that are measured at fair value through profit or loss (debt and equity instruments) are recognized in the Consolidated Statement of Profit or Loss.

"Designated hedging instruments (cash flow hedges)" also belong to financial assets.

› Impairment of financial assets

Infineon determines an impairment charge for expected credit losses for financial assets in the form of debt instruments that are measured at amortized cost or at fair value through other comprehensive income. The calculation of the expected future credit losses is generally determined by multiplying the probability of default by the carrying amount of the financial asset (exposure at default) and the expected loss ratio (loss given default).

Infineon determines impairments for expected credit losses primarily for cash and cash equivalents, financial investments, trade receivables, and contract assets. The expected credit losses are adjusted at each reporting date to reflect changes in credit risk since the instrument was first recognized.

For cash and cash equivalents and financial investments measured at amortized cost, Infineon determines credit losses expected in the next twelve months (twelve-month credit loss) in accordance with the general approach. Due to their short-term maturity, this corresponds to the expected credit losses over the entire term. Infineon rates the credit risk for cash and cash equivalents and financial investments as low. Infineon assumes that a financial asset has a low credit risk if it has an investment grade rating or a corresponding internal investment grade rating. In order to assess whether there has been a significant increase in credit risk since initial recognition, Infineon considers appropriate and robust information that is relevant and available without disproportionately high levels of effort. This includes both quantitative and qualitative information and analyses, which are based on the Company's historical experience and a sound credit assessment as well as forward-looking information. Macroeconomic information is taken into account in the internal rating model (information on Infineon's financial risk management is included in note 27, [p. 211 ff.](#)). Irrespective of the above analysis, a significant increase in credit risk is assumed if a debtor is more than 30 days overdue with the settlement of a contractual payment.

For trade receivables and contract assets, Infineon recognizes credit losses that are expected over the entire term using a simplified procedure. The estimate of expected credit losses on trade receivables and contract assets is based primarily on the analysis of customer financial data, ratings, credit default spreads, past payment behavior of customers and forward-looking information.

In the case of objective indications that expected future cash flows are affected, a financial asset is classified as impaired (with impaired creditworthiness) and adjusted to its individual value. As a rule, this is the case for financial assets (unless it is a trade receivable) no later than 90 days after the due date. For trade receivables, the impaired creditworthiness is not determined automatically in the event of a payment overdue by more than 90 days but always on the basis of the individual assessment of credit management.

A default event occurs when Infineon concludes that the other party would most likely not be able to meet the payment obligations, or not in full.

Financial assets are partly or completely written off, together with previously recognized impairments, if there is no reasonable expectation of repayment. This is generally the case when Infineon finds that the debtor does not have assets or revenue sources that could generate sufficient cash flows to repay the amounts subject to derecognition. Even when financial assets are written off, Infineon continues to conduct enforcement measures to recover them. Amounts recovered are recognized in profit or loss.

Financial liabilities

Infineon classifies financial liabilities into the following categories: “Financial liabilities measured at fair value through profit and loss” and “Other financial liabilities”. Furthermore, “Designated hedging instruments (cash flow hedges)” belong to financial liabilities.

Liabilities measured at fair value through profit or loss by Infineon include derivatives to hedge currency risks for which hedge accounting is not applied, as well as conversion rights from convertible bonds that were acquired in the course of the acquisition of Cypress.

Upon acquisition, other financial liabilities are measured at fair value after deduction of transaction costs. In subsequent periods, they are measured at amortized cost using the effective interest method. The liabilities are derecognized when the contractual obligations are discharged, canceled or expired.

Designated hedging instruments (cash flow hedges)

Certain derivative financial instruments are used to hedge foreign currency and interest risks or risks of commodity price changes (such as gold prices) for firm commitments as well as expected and highly probable future transactions in order to minimize the associated risk (cash flow hedges).

Derivative financial instruments are measured at their fair value and included in “other current assets” or “other current liabilities”.

The effective portion of changes in the fair value of derivative financial instruments, determined in accordance with IFRS 9, that are designated as cash flow hedges and are part of hedging relationships that meet the criteria for hedge accounting is recognized directly in equity. The gain or loss relating to the ineffective portion is recognized

in profit or loss. Amounts accumulated in equity are recycled in profit or loss in the periods in which the underlying hedged item affects profit or loss, or, if the expected transaction subsequently results in the recognition of a non-financial asset, included in the acquisition cost upon initial recognition.

When a hedging instrument expires or is sold, or when a hedging relationship no longer meets the criteria for hedge accounting, any cumulative gain or loss existing at that time remains in equity until the underlying transaction actually occurs. When a forecasted transaction is no longer expected to occur, the cumulative gain or loss that was reported in equity is immediately transferred to profit or loss.

Hybrid bonds

The recognition of a hybrid bond depends on the specific form of the instrument. A hybrid bond is measured and recognized in equity when certain conditions are jointly met. These include, but are not limited to, the fact that the hybrid bond has no final maturity date, that investors have no rights of termination, and that distributions are made at Infineon's discretion. In this case, discounts, transaction costs, tax effects and the remuneration of hybrid investors are deducted directly from equity.

Inventories

Inventories are measured at the lower of historical acquisition or fully absorbed production cost – calculated using the weighted-average method – and net realizable value. Net realizable value corresponds to realizable sale proceeds under normal business conditions less estimated expected costs to complete and sell. Production cost comprises costs of material, production wages and an appropriate portion of attributable overheads, along with attributable depreciation and amortization on property, plant and equipment and other intangible assets. Overhead mark-ups are determined on the basis of normal capacity utilization levels.

Write-downs to net realizable value are recorded on inventories using a consistent approach throughout Infineon and are determined at product level for technically obsolete and slow-moving inventories on the basis of the amount of revenues expected to be generated by the relevant product.

Inventories include an asset resulting from sales with a right of return, representing Infineon's right to recover products from customers upon payment of the reimbursement obligation (see "Revenue recognition", [p. 167 f.](#)). The valuation is made by reference to the previous book value of the products.

Contract assets

Contract assets are recognized if Infineon has fulfilled its performance obligations arising from contracts with customers and an unconditional entitlement to customer consideration does not yet exist.

At Infineon, contract assets result from revenue arising from over-time revenue recognition for certain types of contracts, as well as from sales to some customers for whom Infineon maintains a consignment warehouse and where revenue is recorded at the time of delivery to the consignment warehouse, whereas the invoice is only issued at the time of withdrawal of the product by the customer.

Valuation adjustments for expected credit losses on contract assets are determined in accordance with the measurement method for trade receivables (see "Financial instruments", [p. 161 ff.](#)).

Property, plant and equipment

Property, plant and equipment are measured at amortized acquisition or construction cost, and its value is reduced by depreciation and considering any impairment.

Depreciation on property, plant and equipment is recorded using the straight-line method. Land, property rights and construction in progress are not depreciated on a scheduled basis. Depreciation on property, plant and equipment is based on the following useful lives, as applied consistently throughout Infineon:

	Years
Buildings	25
Technical equipment and machinery	3 – 10
Other plant and office equipment	1 – 10

Other intangible assets

Other intangible assets consist of capitalized development costs and purchased intangible assets; for example, licenses, technologies and customer relationships. These assets have finite useful lives and are valued at their amortized acquisition or production costs with amortization recorded using the straight-line method over their expected economic life.

Amortization of other intangible assets is based on the following useful lives:

	Years
Capitalized development costs	3 – 10
Customer relationships	1 – 12
Technologies	1 – 12
Licenses and similar rights	3 – 5
Other intangible assets	3 – 12

Infineon did not hold any intangible assets with indefinite useful lives in either the 2021 or the 2020 fiscal year.

Recoverability of property, plant and equipment and intangible assets (including goodwill)

Infineon reviews non-current assets, including property, plant and equipment, goodwill and other intangible assets for possible impairment whenever events or changes in circumstances indicate that the carrying amount of an asset may not be recoverable. Regardless of whether an indication of impairment exists, goodwill and other intangible assets, including capitalized development costs not yet subject to amortization, undergo an annual impairment test (see also “Research and development expenses”, [p. 169](#)). The impairment test for goodwill is carried out at the operating segment level annually on 30 June.

The recoverability of an asset is measured by comparing its carrying amount with its recoverable amount. To the extent it is not possible to determine the recoverable amount of an individual asset, the book value of the cash generating unit to which the asset is allocated is compared to its recoverable amount.

A cash generating unit (“CGU”) represents the smallest identifiable group of assets that generates cash inflows from continuing activities and that are largely independent of the cash inflows from other assets or group of assets.

Goodwill arising in connection with a business combination is allocated to the CGUs or groups of CGUs that will benefit from the synergies generated by the business combination.

The recoverable amount of an asset is defined as the higher of its fair value less costs to sell and its value in use. The value in use is calculated based on discounted future cash flows. Considerable management judgment is necessary to estimate future cash flows.

If an asset or CGU is considered to be impaired, the impairment recognized is measured as the amount by which the carrying value exceeds the recoverable amount.

Goodwill is impaired when the carrying amount of the operating segment to which goodwill is allocated exceeds the recoverable amount of that unit.

If the carrying amount of the respective operating segment to which goodwill is allocated exceeds the recoverable amount of this CGU, the goodwill is impaired accordingly.

In the case of property, plant and equipment or other intangible assets, if the recoverable amount of a CGU is less than the carrying value, the impairment is allocated pro rata to the assets recorded within the scope of IAS 36 therein. An impairment loss recognized in prior periods for property, plant and equipment or other intangible assets is reversed insofar as, since the last impairment, a change in the underlying assumptions has occurred, which leads to a lower impairment requirement. The maximum possible reversal of an impairment loss is that which would lead to the carrying amount that would have been determined (net of scheduled depreciation and amortization) if no impairment loss had been recognized for that asset in prior years. The reversal of impairments recognized on goodwill in subsequent periods is not permitted.

Leased assets

IFRS 16 defines a lease as a contract that conveys the right to use an identifiable asset over a specified period of time in exchange for consideration.

At the beginning of a lease, Infineon capitalizes a right of use at amortized acquisition cost and recognizes as a liability a corresponding leasing liability, using the present value of the outstanding lease payments. Rights of use are amortized on a straight-line basis over the expected useful life (see “Property, plant and equipment”, p. 164 f.), or over the duration of the contract if shorter. In subsequent valuations, leasing liabilities

are measured at the current value of the outstanding lease payments using the effective interest method and are presented as lease liabilities (short- and long-term).

The costs associated with leasing agreements with a term of not more than twelve months (provided they do not contain an option to purchase), as well as leasing agreements in which the value of the underlying asset in the leasing contract is small, are recorded in the profit or loss on a straight-line basis in the functional costs. As a general rule, leased assets with a value of up to €5,000 are defined as a low-value asset.

Defined benefit pension plans

The net pension obligation recognized in respect of defined benefit pension plans comprises the present value of the defined benefit obligation (DBO) at the end of the reporting period less the fair value of the plan assets. The present value of the DBO and the resulting pension expense are determined annually in accordance with IAS 19 “Employee Benefits” for each separate plan by independent, qualified actuaries using the projected unit credit method. The calculation is subject to, among other things, assumptions on increases in salaries, future developments in pensions as well as the life expectancy of the beneficiaries. As of the balance sheet date, the obligations are discounted using discount rates determined on the basis of market yields of high-grade, fixed-interest corporate bonds from issuers carrying a very high credit rating.

All items of income and expense relating to defined benefit plans, with the exception of the net interest result, are recognized on a net basis in the functional costs within the operating result. The net interest result arising from the multiplication of the net pension obligation (pension obligation less plan assets) by the discount rate is presented as a financial expense. Actuarial gains and losses arising from changes to actuarial assumptions and estimates as well as the difference between the normalized and actual return on plan assets are recognized directly in equity and recorded in the Consolidated Statement of Comprehensive Income in the periods in which they arise. Past service costs are recognized immediately in profit or loss.

Other provisions

Other provisions are recognized for present legal and/or constructive obligations arising from past events that are likely to result in a future outflow of resources, the amount of which can be reliably estimated.

With regard to legal proceedings and litigation, for example those connected with the Qimonda insolvency, Infineon regularly assesses the probability of an unfavorable outcome. Infineon records provisions and liabilities, including provisions for significant legal costs, for those obligations and risks relating to legal disputes which it assesses at the relevant reporting date are likely to occur. That is where, from Infineon's perspective at the date of assessment, there is compelling evidence which indicates an obligation or risk, and the obligation or risk can be quantified with reasonable accuracy at the time of assessment. As soon as additional information is available, the affected estimates are reviewed and, where necessary, provisions for these proceedings are revised.

Other provisions are measured at their expected settlement amount. The amount recognized for a provision is the best estimate of the expenditure required to settle the present obligation. Estimates of outcomes and financial effects are dependent upon the judgment of management, supplemented by experience gained from similar transactions and, where appropriate, the assessment of independent experts. If the circumstances to be assessed encompass a large number of possible outcomes, the obligation is estimated by weighting all possible outcomes by their associated probabilities (expected value method).

Where cash flows are expected to arise after the next twelve months, the expected settlement amount corresponds to the present value of the expected cash outflows. Discounting is only carried out if the interest effect is significant.

If the obligation decreases because of a change in the estimate, the provision is adjusted accordingly and the resulting income recognized in the same functional area of the Consolidated Statement of Profit or Loss in which the original charge was recognized.

Contingent liabilities

Contingent liabilities are either possible obligations whose actual existence is dependent on the occurrence of one or more uncertain future events not wholly within Infineon's control, or they are present obligations that will probably not result in the outflow of resources or whose outflow of resources cannot be quantified reliably. Contingent liabilities are not recognized in the Statement of Financial Position, instead they are disclosed and described in the Notes to the Consolidated Financial Statements (see note 22, [p. 197](#), and note 23, [p. 198 ff.](#)).

Revenue recognition

Infineon generates revenues mainly from the sale of semiconductor products and related system solutions. Revenue is recognized when control over the products is transferred to the customers in accordance with IFRS 15 (power of disposal), and where the receipt of consideration from the customer is probable. Typically, Infineon's customer contracts only contain one performance obligation which is fulfilled either over a period of time or at a specific point in time, with fulfillment at a specific point in time being the far more common case. For sales of customer-specific products with no alternative use for Infineon, for which Infineon has a legal right to payment for services rendered prior to delivery, revenue is recognized over time. Performance progress is determined using an input-based method and is based on the ratio of costs already incurred to the estimated total cost. If product revenue is not recognized over time, then it is generally recognized upon delivery. The recognition of revenue for deliveries into consignment warehouses depends on the individual contractual

arrangement. Revenue recognition at the point of delivery into the consignment warehouse takes place in cases where the customers have contractual power of control over the products at the point of delivery. Accordingly, in such cases, a contract asset is recorded. Otherwise, revenue is recognized when the products are withdrawn by the customer.

Invoices for sales of products are issued at the time of delivery or withdrawal by the customer from the consignment warehouse and have a short payment term. The amount of revenue corresponds to the expected transaction price to be received by the customer.

The transaction price can include variable components such as rebates or discounts. Infineon can reliably estimate these in accordance with the contractual agreements and historical experience. Variable consideration is only taken into account in so far as it is highly probable that there will be no significant reversal of the revenue. If Infineon expects that the consideration received from the customer is to be reimbursed due to subsequent discounts, a reimbursement obligation is recognized, which is disclosed as other current liabilities.

Infineon recognizes revenue for deliveries to distributors by using the “sell in” method, that is when a product is sold to the distributor, to the extent that revenue has not already been recognized on an over-time basis. The transaction price for sales to distributors, in particular, contains variable components. Distributors can, in accordance with established business practices in the semiconductor industry, under certain circumstances apply for price protection. This allows distributors to receive a credit (debit) note for unsold products held in inventory, where Infineon has reduced (increased) the standard list price of certain products. In addition, in certain cases and for certain products, distributors may request a so-called ship and debit credit note for price adjustments. As with all product sales, Infineon recognizes revenue based on the transaction price and records an obligation for the estimated consideration to be reimbursed to the customer during the period in which the relevant revenue is recognized. The reimbursement obligation is reported within other current liabilities. The determination of the transaction price in the case of ship and debit is based on

rolling historical price trends in the difference between contract prices and standard list prices to the distributors. The determination of the transaction price in the case of price protection takes into account current list prices and the relevant distributors' inventory on hand. The availability of detailed distributor inventory data, the transparency of pricing for standard products and the long distributor pricing history enable Infineon to reliably estimate the adjustments for price protection and ship and debit credit notes at the end of the reporting period.

Distributors can, subject to certain conditions, return a limited amount of inventory (stock return) or request scrap allowances. The estimation of the transaction price is based on the expected stock returns in accordance with the contractual agreement, combined with historical experience. Distributor scrap allowances are taken into account when determining the transaction price based on the contractual agreement and, upon submission of a valid claim, are granted up to a certain maximum based on turnover in a given period. Infineon monitors such product returns on an ongoing basis and adjusts estimate assumptions accordingly. In the case of both stock return and scrap allowances, the consideration to be refunded to the customer is recognized as a reimbursement obligation within other current liabilities. Other returns are only permitted for quality defects within the ordinary warranty period.

The additional costs to obtain a contract are immediately recognized as an expense as soon as they arise, providing the otherwise resulting depreciation period would not exceed one year. Costs to fulfill a contract are capitalized at the earliest when an expected, specifically identifiable contract exists.

Cost of goods sold

Cost of goods sold includes the manufacturing costs of products sold during the reporting period. In addition, cost of goods sold contains idle costs, inventory risks, the cost of warranty cases, as well as the amortization of capitalized development costs. Recognized foreign currency effects, as well as changes in the fair value of undesignated derivative financial instruments that are connected to the operating business, are recognized in cost of goods sold.

Research and development expenses

Costs of research activities are expensed as incurred. Costs for development activities are capitalized if the results lead to a plan or design for the production of new or substantially improved products or process improvements. Capitalization requires that the development costs can be measured reliably, the product or process is technically and commercially feasible, and future economic benefits are probable. In addition, Infineon must intend, and have sufficient resources, to complete development and use or sell the asset. The costs capitalized include the cost of materials, direct labor and directly attributable general overhead expense that serves to prepare the asset for use. Such capitalized costs are presented as internally generated intangible assets within "Other intangible assets" (see note 12, [p. 179 f.](#)). Development costs, which do not fulfill the criteria for capitalization, are expensed as incurred. Capitalized development costs are stated at cost less accumulated amortization and impairment charges.

Grants

Grants are recognized when it is reasonably assured that Infineon will comply with the conditions attached to the grant, and it is reasonably assured that the grant will be received. Investment-related grants are deducted from the purchase and production cost of the related asset and thereby reduce depreciation and amortization expense in future periods.

Grants that are related to expenses are presented as a reduction of the related expense in the Consolidated Statement of Profit or Loss (see note 3, [p. 172](#)).

Current and deferred taxes

The current tax expense is calculated in accordance with taxation provisions in force at the end of the reporting period.

Deferred taxes are calculated on temporary differences between the tax base and the book value of assets and liabilities, and on tax losses available for carry-forward and tax allowances. By contrast, no deferred tax is recognized on initial recognition of goodwill arising in connection with a business combination. Similarly, deferred taxes are not recognized on the initial recognition of an asset or liability in connection with a transaction that is not a business combination and which, at the time of the transaction, affects neither the pre-tax income according to IFRS nor taxable profit. Deferred tax assets and liabilities are measured using applicable tax rates and laws that have been enacted by the end of the reporting period or are about to be enacted, and are to be applied when the related deferred tax asset is realized or the deferred tax liability is settled.

Deferred tax assets in respect of deductible temporary differences, tax loss carry-forwards and tax allowances which exceed deferred tax liabilities in respect of taxable temporary differences, are only recognized to the extent that it is probable that the relevant Group entity can generate sufficient taxable profit to realize the corresponding benefit. Infineon reviews deferred tax assets for impairment at every reporting date. The assessment requires management to make assumptions about future taxable profits as well as other positive and negative influencing factors. This assessment also takes into account insights from the Company's five-year plan as approved in the fiscal year just ended.

Deferred tax assets and liabilities are netted to the extent they relate to the same tax authority and to the same taxpayer or a group of different taxpayers who are jointly assessed for income tax purposes.

Taxes are recognized in the Consolidated Statement of Profit or Loss, with the exception of income taxes relating to items recognized directly in equity or in other comprehensive income.

Tax liabilities are recognized as short-term in accordance with IAS 1.69(d), as they are due immediately, and Infineon generally has no option of deferring their due date.

For uncertain tax positions, a current tax liability is recorded or, in case of a tax loss carried forward or a tax allowance, the respective deferred tax asset is reduced accordingly. IFRIC 23 clarifies the recognition and valuation requirements of IAS 12 where there is uncertainty about tax treatment. Estimates and assumptions must be made for the recognition and valuation, for example, whether an assessment is made separately or together with other uncertainties, whether a probable or expected value is used for the uncertainty, and whether changes have occurred compared to the previous period. The detection risk for the recognition of uncertain tax positions is not relevant. Recognition assumes that the tax authorities investigate the matters in question and that they have all relevant information.

Estimates and assumptions

The preparation of financial statements in accordance with IFRS requires management to make estimates and assumptions that have an impact on the presented amounts and the associated disclosures.

Estimates and assumptions undergo regular review and must be adjusted where appropriate.

Although these estimates and assumptions are applied by management to the best of its knowledge based on current events and circumstances, actual events may result in deviations from these estimates. This applies in particular against the background of the coronavirus pandemic, which is causing distortions in global supply chains, markets and general economic trends. Developments in the wake of the coronavirus pandemic are dynamic, so it cannot be ruled out that the actual results deviate significantly from the estimates and assumptions made in the preparation

of these Consolidated Financial Statements, or that the estimates and assumptions made will have to be adjusted in future periods, and this will have a significant impact on Infineon's financial position, results of operations and cash flows.

Areas containing estimates and assumptions and that are consequently most likely to be affected when actual results vary from estimates and assumptions are:

- › recognition and valuation of deferred tax assets as well as uncertain tax positions (see “Current and deferred taxes”, [p. 169 f.](#), and note 5, [p. 173 ff.](#)),
- › valuation of inventory (see “Inventories”, [p. 164](#), and note 10, [p. 178](#)),
- › revenue recognized over time as well as revenue where the transaction price includes a variable component (see “Revenue recognition”, [p. 167 f.](#)),
- › the recoverability of non-financial assets, in particular goodwill (see notes 12, [p. 179 f.](#), and 13, [p. 181 f.](#)),
- › recognition and valuation of provisions (see “Other provisions”, [p. 167](#), notes 16, [p. 186](#), and 23, [p. 198 ff.](#)) and
- › valuation of defined benefit pension plans (see “Defined benefit pension plans”, [p. 166](#), and note 18, [p. 187 ff.](#)).

All assumptions and estimates are based on the circumstances and assessments as of the balance sheet date, taking into account knowledge gained up to the approval by the Management Board of the Consolidated Financial Statements on 25 November 2021.

3 Notes to the Consolidated Statement of Profit or Loss

Revenue

Breakdowns of revenue by segments, product groups and geographic areas are disclosed in note 28. [p. 219 ff.](#)

The aggregate amount of the transaction prices of the unsatisfied and partially unsatisfied performance obligations, arising from contracts with customers within the meaning of IFRS 15 with expected original durations of more than one year, was as follows as of 30 September 2021 and 2020:

Revenue expected in (€ in millions)	Total	Less than 1 year	1 year and after
As of 30 September 2021	512	157	355
As of 30 September 2020	216	55	161

In contrast, Infineon refrains from disclosing the remaining performance obligations arising from contracts with customers within the meaning of IFRS 15 with original expected durations of one year or less. Accordingly, these values are not included in the table above.

Cost of materials and purchased services as well as personnel expenses

The Consolidated Statement of Profit or Loss (continuing and discontinued operations) includes the following expenses for purchased services, materials and personnel.

Expenses for materials and purchased services comprised the following in the 2021 and 2020 fiscal years:

€ in millions	2021	2020
Cost of raw materials, supplies and purchased goods	1,925	1,712
Cost of purchased services	2,609	1,975
Total	4,534	3,687

Personnel expenses comprised the following in the 2021 and 2020 fiscal years:

€ in millions	2021	2020
Wages and salaries	3,108	2,476
Social insurance levies and employee benefits	471	370
Expenses for pensions	67	70
Total	3,646	2,916

The average number of employees by geographic region was as follows for the 2021 and 2020 fiscal years:

	2021	2020
Europe	19,767	18,894
therein: Germany	12,680	12,201
Asia-Pacific (excluding Japan, Greater China)	20,457	17,818
Greater China ¹	2,423	2,218
therein: Mainland China, Hong Kong	2,086	1,967
Japan	648	432
Americas	5,296	4,438
therein: USA	3,772	2,877
Total	48,591	43,800

¹ Greater China comprises Mainland China, Hong Kong and Taiwan.

Grants

Infineon has received grants from various governmental institutions under government business development programs, including grants for the construction of manufacturing facilities, for research and development activities, and employee development. Grants included directly in profit or loss in the Consolidated Financial Statements during the 2021 and 2020 fiscal years were as follows:

€ in millions	2021	2020
Included in the Consolidated Statement of Profit or Loss in:		
Cost of goods sold	58	40
Research and development expenses	123	108
Selling, general and administrative expenses	5	4
Total	186	152

Of the grants totaling €186 million (2020: €152 million) included in the Consolidated Statement of Profit or Loss in the 2021 fiscal year, €64 million (2020: €132 million) related to expenses from previous years.

In the 2021 fiscal year, investment grants of €20 million (2020: €21 million) were deducted from acquisition or construction costs for property, plant and equipment and intangible assets. In the 2021 fiscal year, Infineon received investment grants of €12 million (2020: €30 million).

For compliance with the conditions attached to the grants received and potential repayment requirements in case of nonfulfillment, see note 22. [p. 197](#)

Financial income and expenses

Financial income comprised the following in the 2021 and 2020 fiscal years:

€ in millions	2021	2020
Interest income	5	29
Gains on sales of financial assets	13	-
Other financial income	4	-
Total	22	29

Financial expenses comprised the following in the 2021 and 2020 fiscal years:

€ in millions	2021	2020
Interest expenses	(155)	(130)
Other financial expenses	(27)	(47)
Total	(182)	(177)

Financial expenses included other financial expenses of €3 million (2020: €25 million) in the 2021 fiscal year, as well as interest expenses of €5 million (2020: €1 million) in connection with interest rate derivatives concluded to hedge refinancing measures.

Further information on Infineon's financial income and expenses is contained in note 26. [p. 207](#)

4 Investments accounted for using the equity method

The investments accounted for using the equity method comprise shares in joint ventures and associated companies.

Summarized financial information for joint ventures

As of 30 September 2021 and 2020, the carrying amount of joint ventures accounted for using the equity method was €23 million and €21 million, respectively. The pro rata result from joint ventures accounted for using the equity method for the 2021 fiscal year was €2 million (2020: negative €8 million).

For the 2021 and 2020 fiscal years, Infineon's proportion of selected items from the statement of comprehensive income of the joint ventures accounted for using the equity method were aggregated as follows:

€ in millions	2021	2020
Income (loss) for the year, net of tax	2	(8)
Total comprehensive income (loss) for the year, net of tax	2	(8)

The pro rata result of the joint ventures accounted for using the equity method is not part of the Segment Result (see note 28, [p. 220](#)).

Summarized financial information for associated companies

As of 30 September 2021 and 2020, the carrying amount of the associated companies accounted for using the equity method was €48 million and €66 million, respectively. The pro rata result from associated companies accounted for using the equity method for the 2021 fiscal year was €7 million (2020: negative €1 million).

For the 2021 and 2020 fiscal years, Infineon's proportion of selected items from the statement of comprehensive income of the associated companies accounted for using the equity method were aggregated as follows:

€ in millions	2021	2020
Income (loss) for the year, net of tax	7	(1)
Total comprehensive income (loss) for the year, net of tax	7	(1)

The pro rata result of the associated companies accounted for using the equity method is not part of the Segment Result (see note 28, [p. 220](#)).

5 Income tax

Income tax from continuing operations for the fiscal years ending 30 September 2021 and 2020 amounts to:

€ in millions	2021	2020
Current tax expense	(152)	(94)
Deferred tax income	8	42
Income tax	(144)	(52)

Current tax expense included tax income of €59 million (2020: €46 million tax income) relating to previous fiscal years.

The German combined statutory tax rate for Infineon Technologies AG was 28 percent for the 2021 and 2020 fiscal years. This is based on a corporate income tax rate of 15 percent, plus a solidarity surcharge of 5.5 percent and a trade tax rate of 12 percent.

Taxable income earned by foreign subsidiaries is determined on the basis of the tax laws applicable in the relevant countries and is taxed based on the respective country-specific tax rates.

The reconciliation of income taxes from continuing operations for the fiscal years ended 30 September 2021 and 2020, based on the German combined statutory income tax rate of 28 percent (2020: 28 percent), is as follows:

€ in millions	2021	2020
Expected income tax expense	(367)	(118)
Tax rate differential	47	33
Effects due to changes in tax rates	(15)	(5)
Effects from the difference between local and functional currency	1	(14)
Previous year taxes	73	50
Non-deductible expenses	(33)	(27)
Tax-exempt income	66	33
Change in permanent balance sheet effects	(50)	(23)
Change in valuation allowance on deferred tax assets	64	(10)
Change in available tax credits	64	47
Other	6	(18)
Actual income taxes	(144)	(52)

“Effects due to changes in tax rates” related to a change in the applicable tax rates in Singapore and the USA.

€ in millions	30 September 2021		Change 2021		30 September 2020		Change 2020	
	Deferred tax assets	Deferred tax liabilities	Total	therein through profit or loss	Deferred tax assets	Deferred tax liabilities	Total	therein through profit or loss
Intangible assets	35	(727)	9	12	39	(740)	(534)	22
Property, plant and equipment	146	(142)	(29)	(29)	162	(129)	(102)	(34)
Provisions, pensions and similar commitments	310	(170)	40	53	273	(173)	109	33
Tax loss carry-forwards	577	-	(29)	(66)	606	-	213	19
Unused tax credits and excess foreign tax credits	201	-	17	17	184	-	61	(11)
Other	193	(52)	29	21	166	(54)	8	13
Total deferred taxes	1,462	(1,091)	37	8	1,430	(1,096)	(245)	42
Netting	(767)	767	-	-	(803)	803	-	-
Total	695	(324)	37	8	627	(293)	(245)	42

The category “Other” includes a reduction of deferred tax liabilities of €10 million (2020: increase of €20 million) as a result of the recognition of deferred tax in connection with investments of subsidiaries.

In the 2021 fiscal year, the tax expense from the valuation allowances or non-recognition of deferred tax assets for tax loss carry-forwards amounted to €23 million (2020: €1 million), for tax credits to €8 million (2020: €46 million), and from temporary differences to €1 million (2020: €0 million). A write-up of deferred tax assets for tax loss carry-forwards of €77 million was recorded (2020: €37 million). With respect to the deferred tax assets for temporary differences, the write-up amounted to €19 million in the 2021 fiscal year (2020: €0 million).

The utilization of tax loss carry-forwards, tax credits and temporary differences for which deferred tax assets had not previously been recorded resulted in current tax income of €5 million in the 2021 fiscal year (2020: €5 million).

Deferred tax assets and liabilities as of 30 September 2021 and 2020 comprised the following:

In Germany, Infineon Technologies AG accumulated corporate income tax loss carry-forwards of €1.3 billion and trade tax loss carry-forwards of €2.5 billion as of 30 September 2021 (30 September 2020: €1.5 billion and €2.7 billion, respectively).

In other jurisdictions, corporate income tax loss carry-forwards amounted to €313 million (30 September 2020: €717 million) and local income tax loss carry-forwards amounted to €398 million (30 September 2020: €287 million). Additionally, there were unused tax credits of €625 million (30 September 2020: €596 million).

Infineon assessed the need for a valuation allowance of its deferred tax assets. Based on the results of such assessment, considering all positive and negative factors and information relating to the foreseeable future based on business plans, Infineon recognized deferred tax assets, after netting, of €695 million as of 30 September 2021 (30 September 2020: €627 million).

Deferred tax assets in the amount of €447 million were recognized for legal entities which have incurred tax losses in the prior year. In the prior fiscal year, those entities recorded deferred tax assets in the amount of €408 million. Such tax losses are primarily incurred due to extraordinary items with respect to the acquisition of Cypress in the prior year. It is expected that these legal entities based on company forecast incur positive taxable results in the next years. Special considerations are given to unforeseen items that could impact these results.

No deferred taxes were recorded for the following items (gross amounts):

€ in millions	2021	2020
Tax loss carry-forwards (domestic and foreign)	41	58
Local tax loss carry-forwards (particularly German trade tax and US state taxes)	333	1,129
Tax credits	424	412
Temporary differences	464	651

Of the foreign corporate tax loss carry-forwards, for which no deferred tax assets were recognized, €0 million (2020: €18 million), of the local income tax loss carry-forwards €59 million (2020: €5 million) and of tax credits €2 million (2020: €0 million) will expire in the next five years.

The change in the net amount of deferred tax assets and liabilities is as follows:

€ in millions	2021	2020
Deferred taxes, net as of the end of the previous fiscal year	334	579
Deferred tax income (expense), recognized through income statement:		
From continuing operations	8	42
From discontinued operations	-	-
Change of deferred taxes, recognized directly in equity:		
Deferred tax arising from business acquisitions	-	(352)
Deferred taxes recognized directly in equity	28	27
Deferred taxes recognized in other comprehensive income	6	20
Foreign currency translation	(2)	21
Adjustment on initial application of IFRS 9 and IFRS 15	(3)	(3)
Deferred taxes, net as of the end of the fiscal year	371	334

In connection with investments in subsidiaries, there were taxable temporary differences of €349 million (2020: €544 million) for which no deferred taxes have been recognized because the timing of the reversal can be controlled, and it is not probable that the temporary differences will reverse in the foreseeable future.

Including the items recognized directly in equity and in other comprehensive income and the expense/benefit from continuing and discontinued operations, the income tax consisted of the following:

€ in millions	2021	2020
Income taxes from continuing operations	(144)	(52)
Income taxes from discontinued operations	1	-
Income taxes recognized directly in equity	29	25
Income taxes recognized in other comprehensive income	6	21
Income taxes	(108)	(6)

The income taxes recognized in other comprehensive income resulted from tax effects of €17 million (2020: €27 million) from realized and non-realized gains and losses from hedges offset by taxes on actuarial gains and losses arising from pension commitments of €11 million (2020: increase €6 million). Income taxes recognized directly in equity were the result of tax effects in connection with the compensation on hybrid capital as well as tax effects from reversal of valuation allowances on deferred tax assets resulting from capital measures in prior years.

6 Disposals and discontinued operations

Qimonda – discontinued operations

On 23 January 2009, Qimonda AG (“Qimonda”), a majority-owned company, filed an application at the Munich Local Court to commence insolvency proceedings. On 1 April 2009, the insolvency proceedings formally opened. Insolvency proceedings were also opened for further domestic and foreign subsidiaries of Qimonda. Some

of these insolvency proceedings have already been completed. The impacts of these proceedings are reported as discontinued operations in Infineon’s Consolidated Statement of Profit or Loss and Consolidated Statement of Cash Flows, to the extent that the underlying events occurred before the commencement of insolvency proceedings.

The current risks and provisions relating to Qimonda’s insolvency are described in note 23 “Proceedings in relation to Qimonda”. [p. 198 f.](#)

In the 2021 and 2020 fiscal years, adjustments to individual provisions as well as subsequent income arose as a result of recent developments in connection with the insolvency of Qimonda, which resulted in a loss from discontinued operations, net of income taxes of €6 million and €4 million, respectively.

7 Earnings per share

Basic earnings per share are calculated by dividing profit (loss) for the period by the weighted-average number of shares outstanding during the reporting period. The calculation of the diluted earnings per share is based on the assumption that all potentially dilutive instruments are converted into ordinary shares, resulting in a corresponding increase in the number of shares.

The hybrid bond issued in the 2020 fiscal year is classified as equity (see note 19, [p. 193](#)). The related hybrid investors’ remuneration entitlement (after tax) represents payments for a component of equity that reduces the earnings available to shareholders for distribution and was therefore taken into account in determining earnings per share (basic and diluted).

Basic and diluted earnings per share are calculated as follows for the fiscal years ended 30 September 2021 and 2020:

€ in millions (unless otherwise stated)	2021	2020
Profit (loss) for the period – basic and diluted	1,169	368
Remuneration entitlement of hybrid capital investors ¹	26	35
Profit (loss) for the period attributable to shareholders of Infineon Technologies AG – basic and diluted	1,143	333
thereof from continuing operations	1,149	337
thereof from discontinued operations	(6)	(4)
Weighted-average number of shares outstanding (in millions):		
– Ordinary share capital	1,305.9	1,269.8
– Adjustment for own shares	(4.7)	(5.3)
Weighted-average number of shares outstanding – basic	1,301.2	1,264.5
Adjustments for:		
– Effect of share-based compensation	2.5	1.0
Weighted-average number of shares outstanding – diluted	1,303.7	1,265.5
Basic and diluted earnings per share² (in euro):		
Earnings per share (in euro) from continuing operations	0.88	0.26
Earnings per share (in euro) from discontinued operations, net of income taxes	(0.01)	–
Earnings per share (in euro) – basic and diluted	0.87	0.26

1 Including the cumulative tax effect.

2 The calculation of earnings per share is based on unrounded figures.

8 Financial investments

Financial investments comprise fixed-term deposits with banks and investment funds. Fixed-term deposits with banks are categorized as financial assets and measured at amortized cost. Investment funds are categorized as financial assets and measured at fair value through profit or loss (see also note 2, [p. 161 ff.](#), and note 26, [p. 203 ff.](#)).

Financial investments as of 30 September 2021 and 2020 comprised the following:

€ in millions	30 September 2021	30 September 2020
Fixed-term bank deposits	1,108	600
Investment funds	1,066	777
Financial investments, gross	2,174	1,377
Loss allowances	(1)	(1)
Financial investments, net	2,173	1,376

The impairment losses on financial investments that are measured at amortized cost changed as follows during the 2021 and 2020 fiscal years:

€ in millions	2021	2020
Allowances at beginning of the fiscal year	1	–
Revaluation of allowances, net	–	1
Allowances at end of the fiscal year	1	1

Information on Infineon's credit risk management is contained in note 27. [p. 214 ff.](#)

9 Trade receivables

Trade receivables result from contracts with customers that are due within one year. As of 30 September 2021 and 2020, they consisted of the following:

€ in millions	30 September 2021	30 September 2020
Trade receivables, third parties	1,479	1,192
Trade receivables, related parties	9	9
Trade receivables, gross	1,488	1,201
Loss allowances	(5)	(5)
Trade receivables, net	1,483	1,196

Changes in the allowances for trade receivables in the 2021 and 2020 fiscal year were as follows:

€ in millions	2021	2020
Allowances at beginning of the fiscal year	5	7
Current year's allowance, net of reversals	-	(2)
Usage of loss allowances, net	-	-
Allowances at end of the fiscal year	5	5

Information about Infineon's credit risk management is contained in note 27. [□ p. 214 ff.](#)

10 Inventories

Inventories as of 30 September 2021 and 2020 consisted of the following:

€ in millions	30 September 2021	30 September 2020
Raw materials and supplies	279	215
Work in progress	1,464	1,341
Finished goods and merchandise	438	496
Total	2,181	2,052

Cost of goods sold consisted mainly of inventory-related expenses in the 2021 and 2020 fiscal years.

As of 30 September 2021 and 2020, finished goods and merchandise contained an asset resulting from sales with a right of return of €12 million and €13 million, respectively.

Inventory write-downs as of 30 September 2021 and 2020 amounted to €232 million and €252 million, respectively.

11 Other current assets

Other current assets as of 30 September 2021 and 2020 consisted of the following:

€ in millions	30 September 2021	30 September 2020
VAT and other receivables from tax authorities	250	167
Prepaid expenses	106	92
Grants receivables	94	71
Derivative financial instruments (see note 26, □ p. 207 ff.)	2	3
Other	66	197
Total	518	530

12 Property, plant and equipment and other intangible assets

The development of property, plant and equipment as well as other intangible assets for the years ended 30 September 2021 and 2020 was as follows:

	Cost					Depreciation/amortization					Carrying amount			
	1 October 2020	Additions	Disposals	Reclassification	Foreign currency effects	30 September 2021	1 October 2020	Depreciation/amortization	Disposals	Impairments/reversals of impairments	Foreign currency effects	30 September 2021	30 September 2020	
€ in millions														
Property, plant and equipment														
Land, land rights and buildings	1,996	252	(3)	48	9	2,302	(921)	(76)	3	9	(4)	(989)	1,313	1,075
Technical equipment and machinery	10,328	669	(126)	236	22	11,129	(8,189)	(737)	123	-	(19)	(8,822)	2,307	2,139
Other plant and office equipment	1,349	120	(53)	37	4	1,457	(1,204)	(123)	52	-	(4)	(1,279)	178	145
Payments on account and construction in progress	753	218	(7)	(321)	2	645	(2)	-	2	-	-	-	645	751
Total property, plant and equipment	14,426	1,259	(189)	-	37	15,533	(10,316)	(936)	180	9	(27)	(11,090)	4,443	4,110
Other intangible assets														
Capitalized development costs	1,033	199	(14)	-	2	1,220	(393)	(69)	14	-	-	(448)	772	640
Customer relationships	1,321	-	-	-	12	1,333	(396)	(191)	-	-	(8)	(595)	738	925
Technologies	2,190	-	-	-	24	2,214	(296)	(214)	-	(7)	(11)	(528)	1,686	1,894
Licenses and similar rights	276	30	(1)	-	1	306	(201)	(29)	-	-	-	(230)	76	75
Remaining other intangible assets	105	-	-	-	1	106	(18)	(9)	-	(1)	(1)	(29)	77	87
Total other intangible assets	4,925	229	(15)	-	40	5,179	(1,304)	(512)	14	(8)	(20)	(1,830)	3,349	3,621

	Cost						30 Sep- tember 2020	Depreciation/amortization					30 Sep- tember 2020	Carrying amount	
	1 October 2019	Additions	Additions through business combi- nations	Disposals	Reclassi- fication	Foreign currency effects		1 October 2019	Depre- ciation/ amor- tization	Disposals	Impair- ments/ reversals of impair- ments	Foreign currency effects		30 Sep- tember 2020	30 Sep- tember 2020
€ in millions															
Property, plant and equipment															
Land, land rights and buildings	1,660	54	278	(1)	36	(31)	1,996	(885)	(55)	1	11	7	(921)	1,075	775
Technical equipment and machinery	9,652	285	299	(84)	228	(52)	10,328	(7,602)	(698)	84	-	27	(8,189)	2,139	2,050
Other plant and office equipment	1,311	78	-	(50)	19	(9)	1,349	(1,151)	(110)	50	-	7	(1,204)	145	160
Payments on account and construction in progress	525	507	11	(1)	(283)	(6)	753	-	-	-	(2)	-	(2)	751	525
Total property, plant and equipment	13,148	924	588	(136)	-	(98)	14,426	(9,638)	(863)	135	9	41	(10,316)	4,110	3,510
Other intangible assets															
Capitalized development costs	894	158	-	(18)	-	(1)	1,033	(351)	(56)	18	(4)	-	(393)	640	543
Customer relationships	406	-	998	-	-	(83)	1,321	(276)	(131)	-	-	11	(396)	925	130
Technologies	338	-	2,011	-	-	(159)	2,190	(188)	(125)	-	-	17	(296)	1,894	150
Licenses and similar rights	260	26	3	(12)	-	(1)	276	(192)	(23)	12	-	2	(201)	75	68
Remaining other intangible assets	18	-	96	-	-	(9)	105	(13)	(6)	-	-	1	(18)	87	5
Total other intangible assets	1,916	184	3,108	(30)	-	(253)	4,925	(1,020)	(341)	30	(4)	31	(1,304)	3,621	896

Depreciation on property, plant and equipment is presented in the Consolidated Statement of Profit or Loss mainly in cost of goods sold. Amortization of intangible assets is mainly presented in cost of goods sold or selling, general and administrative expenses. Impairments on property, plant and equipment and other intangible assets are reported under other operating expenses.

Property, plant and equipment of €13 million as of 30 September 2021 (30 September 2020: €182 million) was assigned as security.

13 Goodwill

Changes in goodwill during the 2021 and 2020 fiscal years were as follows:

€ in millions	2021	2020
Cost		
Balance at the beginning of the fiscal year	5,897	909
Additions through business combinations	-	5,430
Foreign currency effects	65	(442)
Balance at the end of the fiscal year	5,962	5,897
Accumulated impairments and other changes		
Balance at the beginning of the fiscal year	-	-
Impairments	-	-
Disposals	-	-
Foreign currency effects	-	-
Balance at the end of the fiscal year	-	-
Carrying amount		
Balance at the beginning of the fiscal year	5,897	909
Balance at the end of the fiscal year	5,962	5,897

The amounts shown in the 2020 fiscal year under “Additions through business combinations” resulted exclusively from the acquisition of Cypress.

Infineon carried out the annual goodwill impairment test at the operating segment level as of 30 June 2021.

Infineon determines the recoverable amount of a particular cash generating unit to which goodwill has been allocated on the basis of its value in use. The value in use is measured by estimating the present value of future cash flows that will be generated by the continuing operations of the CGU discounted using an appropriate discount rate.

Cash flows, including the underlying parameters such as revenue growth and margins, are projected based on past experience, current operating results and the business plan approved in the fiscal year just ended, which is calculated bottom-up based on certain central assumptions applied consistently throughout Infineon. Cash flows over a five-year period are used to derive the value in use. The derivation of the terminal value is based on a stable business state, reflecting synergies resulting from the acquisition of Cypress. The average revenue growth rates over the planning period are between 8.7 percent and 12.4 percent, which is in part higher than the average historical growth rates of the sectors in which the relevant segments operate, mainly because the segments benefit to varying degrees from the businesses acquired with Cypress and the related revenue and costs synergies. Investments to increase capacity for which no cash outflow has taken place are not taken into account. Cash flows for periods beyond the planning horizon are estimated using a terminal value.

The discount rate for future cash flows is based on the after-tax weighted-average cost of capital (“WACC”) for the CGU in question. The Capital Asset Pricing Model (“CAPM”) is used to calculate the cost of equity. The relevant pre-tax WACC used to discount future pre-tax cash flows in line with IAS 36, is derived from estimated future after-tax cash flows and the after-tax WACC using a typical tax rate for each operating segment. The risk-free interest rate is derived using the Svensson method, taking into account risk premiums, the beta factor and debt ratio are derived from a group of companies comparable to the operating segment. In this way, the discount rate derived reflects the current market rate of return as well as the specific risks attached to the respective operating segment.

The following table shows the allocation of the carrying amount of goodwill to the segments, as well as the valuation parameters used:

Operating segment	Book value of allocated goodwill € in millions		Pre-tax WACC ¹ in %		After-tax WACC ¹ in %		Terminal growth rate ¹ in %	
	2021	2020	2021	2020	2021	2020	2021	2020
Automotive	1,418	1,402	11.1	10.9	8.6	8.6	1.5	1.5
Industrial Power Control	228	226	11.9	11.9	8.9	9.1	1.5	1.5
Power & Sensor Systems	1,697	1,679	12.5	12.3	9.5	9.5	1.5	1.5
Connected Secure Systems	2,617	2,588	10.8	10.7	8.7	8.7	1.5	1.5
Corporate	2	2						
Total	5,962	5,897						

¹ Valuation parameters as of 30 June 2021 and 2020.

As a result of the impairment tests carried out, Infineon concluded that none of the operating segments gave rise to an impairment of goodwill in the year under report.

Business planning is affected, among other things, by uncertainties regarding the assessment of markets and the macroeconomic environment and is based to a large extent on the assumption that the revenue and cost synergies expected from the acquisition of Cypress will be successfully realized. Therefore, sensitivity analyses

were carried out at operating segment level, taking into account changes considered possible in the main assumptions. Even taking these changes into account, no impairment on goodwill was observed as a result of the sensitivity analyses at operating segment level.

In addition, as of the reporting date, there was no indication that the recoverable amount of an operating segment to which goodwill had been allocated could have fallen below the book value.

14 Leases

The changes in the rights of use in the 2021 and 2020 fiscal year were as follows:

€ in millions	1 October 2020	Additions	Additions through business combi- nations	Depreciation	Other changes ¹	30 Septem- ber 2021
Land, land rights and buildings	267	110	-	(56)	(2)	319
Technical equipment and machinery	9	1	-	(3)	1	8
Other plant and office equipment	10	6	-	(6)	(1)	9
Total	286	117	-	(65)	(2)	336

¹ Other changes for land, land rights and buildings include reversals of impairments amounting to €6 million.

€ in millions	1 October 2019	Additions	Additions through business combi- nations ¹	Depreciation	Other changes ²	30 Septem- ber 2020
Land, land rights and buildings	240	66	32	(48)	(23)	267
Technical equipment and machinery	5	-	7	(2)	(1)	9
Other plant and office equipment	10	9	-	(6)	(3)	10
Total	255	75	39	(56)	(27)	286

¹ The amounts shown under "Additions through business combinations" resulted in the 2020 fiscal year exclusively from the acquisition of Cypress.

² Other changes for land, land rights and buildings include impairments amounting to €11 million.

The allocation of discounted and undiscounted lease liabilities by maturity as of 30 September 2021 and 2020 was as follows:

€ in millions	30 September 2021		30 September 2020	
	Discounted lease liabilities	Undiscounted lease liabilities	Discounted lease liabilities	Undiscounted lease liabilities
Due within one year	66	68	59	60
Due after one year to five years	139	145	159	172
Due after more than five years	126	133	76	85
Total	331	346	294	317

The Consolidated Statement of Profit or Loss includes the following amounts in the 2021 and 2020 fiscal year, which are attributable to leases:

€ in millions	2021	2020
Depreciation	65	56
Impairment (Reversal of impairment)	(6)	11
Interest expenses	4	5
Expenses for short-term leases with a term of twelve months or less	6	1
Expenses for low-value leases	3	1
Total	72	74

The Consolidated Statement of Cash Flows includes the following amounts in the 2021 and 2020 fiscal year, which are attributable to leases:

€ in millions	2021	2020
Payments for short-term leases and low-value leases	9	2
Payments for leasing liabilities	76	63
Interest payments	4	4
Total	89	69

Due to the requirements of IFRS 16, the following future lease payments have not been included in the valuation of lease liabilities:

€ in millions	2021	2020
Payments for not reasonably certain renewal options		
Due within one year	–	1
Due after one year to five years	4	11
Due after more than five years	88	58
Total	92	70

In addition, there are future payment obligations for leases that have not been started but have already been contracted, as well as for short-term leases with a term of twelve months or less, which are immaterial.

The leasing contracts concluded relate mainly to the rental of office and storage space, IT equipment, other operating and office equipment as well as vehicles for selected employees.

Infineon's leases have no material impact on covenants connected to debt financing instruments. In addition, lease liabilities are not part of the net cash position measure used for capital market reporting purposes.

The leasing contracts, in which Infineon subleases and acts as a lessor, are not material from the Group's point of view.

The expected future minimum non-discounted lease payments from operating leases for land and buildings owned by Infineon and in which Infineon acts as lessor are as follows:

€ in millions	30 September 2021	30 September 2020
Due within one year	20	19
Due after one year to five years	39	60
Due after more than five years	1	2
Total	60	81

15 Financial debt

Financial debt as of 30 September 2021 and 2020 consisted of the following:

€ in millions	30 September 2021	30 September 2020
Short-term financial debt and current portion of long-term financial debt, weighted average interest rate: 1.25% (2020: 2.01%)	3	176
Bond €500 million, coupon 1.50%, due 2022	500	–
Convertible bonds, weighted average interest rate 4.50% (2020: 4.50%)	330	329
Short-term financial debt and current portion of long-term financial debt	833	505
Unsecured loans, weighted average interest rate 0.87% (2020: 1.06%), due 2023	3	6
Bond €500 million, coupon 1.50%, due 2022	–	499
Bond €750 million, coupon 0.75%, due 2023	747	746
Bond €750 million, coupon 1.125%, due 2026	744	743
Bond €750 million, coupon 1.625%, due 2029	741	740
Bond €650 million, coupon 2.00%, due 2032	638	636
Term loan US\$1,110 million, weighted average interest rate 1.04% (2020: 1.66%), due 2024 ¹	954	2,361
USPP notes US\$935 million, weighted average interest rate 4.09%, due 2024–2028	806	797
USPP notes US\$1,300 million, weighted average interest rate 2.88%, due 2027–2033	1,119	–
Long-term financial debt	5,752	6,528
Total	6,585	7,033

¹ This is a variable-interest financial liability.

In June 2019 Infineon Technologies AG concluded unsecured, non-subordinated financing for the acquisition of Cypress with various national and international banks comprising:

- › a bridge facility of €6,600 million with a maturity of up to two years and nine months from the date of the loan commitment, and
- › three term loan tranches, each amounting to US\$1,110 million, with maturities of three, four and five years.

The bridge financing was fully repaid in the previous year as a result of various equity and debt measures. In addition, a portion of the term loan maturing in 2022 in the amount of US\$555 million was repaid in the previous year.

Infineon signed a US private placement of notes (USPP) with a nominal value of US\$1,300 million in April 2021. The unsubordinated, unsecured USPP notes, which bear an average interest rate of 2.88 percent per annum, were broken down as follows:

- › Notes with a nominal value of US\$350 million due in 2027,
- › Notes with a nominal value of US\$350 million due in 2029,
- › Notes with a nominal value of US\$350 million due in 2031,
- › Notes with a nominal value of US\$250 million due in 2033.

Following completion of the transaction on 16 June 2021, parts of the existing term loans in the amount of US\$1,300 million were repaid. In addition, Infineon repaid term loans of US\$365 million in the 2021 fiscal year. As a result, the term loans maturing in 2022 and 2023, respectively, were repaid in full. As of 30 September 2021, only one term loan in the amount of US\$1,110 million maturing in 2024 remained outstanding.

On 16 October 2020, the MoTo Objekt CAMPEON GmbH & Co. KG secured loans in the amount of €171 million were repaid.

Financial debt, with the exception of conversion rights on outstanding convertible bonds, are recognized at amortized cost after deduction of directly attributable transaction costs. The conversion rights, which can only be exercised against cash payment after the acquisition of Cypress, are measured at fair value through profit or loss (see note 26, [p. 206](#)).

The total lines of credit as of 30 September 2021 and 2020 are summarized in the following table:

Term, € in millions	30 September 2021			30 September 2020		
	Aggregate facility	Drawn	Available	Aggregate facility	Drawn	Available
Short-term	72	3	69	245	176	69
Long-term	962	962	–	2,376	2,376	–
Total	1,034	965	69	2,621	2,552	69

Amounts of financial debt and interest maturing in the coming years were as follows:

€ in millions	30 September 2021		30 September 2020	
	Financial debt	Interest	Financial debt	Interest
Due within one year	833	125	505	121
Due after one year to five years	3,066	397	3,925	330
Due after more than five years	2,726	261	2,650	203
Total	6,625	783	7,080	654

16 Provisions

Current and non-current provisions as of 30 September 2021 consisted of the following:

€ in millions	1 October 2020	Addition	Usage	Reversal	30 Septem- ber 2021
Obligations to employees	420	698	(309)	(19)	790
Provisions related to Qimonda (see note 6, □ p. 176 , and note 23, □ p. 198 f.)	206	9	(4)	-	211
Warranties	40	17	(8)	(9)	40
Other	83	28	(13)	(5)	93
Total provisions	749	752	(334)	(33)	1,134
thereof current	436				815
thereof non-current	313				319

Obligations to employees included, among others, costs of variable remuneration, outstanding vacation and flextime, service anniversary awards, other personnel costs and social security costs.

Provisions for warranties mainly represented the estimated future cost of fulfilling contractual requirements associated with products sold.

Other provisions comprised provisions for litigations (other than those relating to Qimonda), restructuring, asset retirement obligations and miscellaneous other liabilities.

Of the total provisions as of 30 September 2021 and 2020, a cash outflow of €815 million and €436 million, respectively, was expected to occur within one year. For the non-current provisions, a cash outflow was expected to occur after more than one year. Besides the provisions in connection with Qimonda, €42 million and €44 million as of 30 September 2021 and 2020, respectively, of non-current provisions were attributable to length-of-service related anniversary awards.

17 Other current liabilities

Other current liabilities as of 30 September 2021 and 2020 consisted of the following:

€ in millions	30 Septem- ber 2021	30 Septem- ber 2020
Reimbursement obligations	395	405
Payroll and similar obligations to employees	206	221
Accrued interest expense	104	96
Other financial liabilities relating to interest hedging of refinancing measures (see note 26, □ p. 208 f.)	-	66
Contract liabilities	12	4
Other	155	158
Total	872	950

Contract liabilities amounted to €25 million as of 30 September 2021 and 2020, respectively. Of this amount, €13 million (30 September 2020: €21 million) related to non-current contract liabilities reported under other non-current liabilities.

18 Pension plans

Defined benefit pension plans

Infineon's employee benefit plans consist of domestic and foreign defined benefit and defined contribution pension plans providing retirement, disability and surviving dependents' benefits. For Infineon, the significant benefit plans in Germany pertain to Infineon Technologies AG, and are among the foreign benefit plans to Infineon Technologies Austria AG.

In Germany, Infineon primarily offers defined contribution benefits which provide for the employees when they reach retirement age, or in the event of disability or death. The statutory framework is provided by the Company Pension Act (in German: Betriebsrentengesetz or "BetrAVG") and by employment law in general. With the Infineon pension plan, new entrants receive a defined contribution benefit, which is funded by Infineon. Payments by the Infineon pension plan are generally made in twelve annual installments. For active employees who were entitled to benefits in the form of an annuity before the Infineon Pension Plan came into force, this commitment was transferred into the Infineon Pension Plan and thereby the possibility of an annuity is guaranteed. Together with former employees whose pension benefit obligations were not transferred into the Infineon Pension Plan, this group makes up the largest part of the obligation at this time. A corresponding provision is recorded for the German defined benefit pension plans, which are partly backed by plan assets. Individual agreements are in place for the members of the Management Board, which are backed by plan assets (see detailed in the chapter "Remuneration report" in the Combined Management Report, [p. 145 f.](#)). The major portion of the plan assets is managed by a pension trust in the legal form of a registered association. This is composed of executives of Infineon Technologies AG, and the investment strategy is defined by Infineon Technologies AG.

The benefit obligation of some foreign plans is measured according to the income in the last month or year of service; others are dependent on average income over the service period. Foreign pension plans are managed by country-specific external pension funds or other pension schemes. The obligation arising from foreign defined benefit pension plans are partly covered by plan assets. The management of existing foreign plan assets is performed by the respective pension scheme.

The valuation date of both the German and foreign pension plans is 30 September.

The Group-defined benefit pension plans are exposed to risks arising from changes to actuarial assumptions such as interest rates, salary and pension trends, investment risks and longevity risks. A lower discount rate leads to higher pension liabilities. Equally, lower than expected growth in plan assets could lead to a deterioration of the funded status, or require the payment of additional contributions.

The development of Infineon's German (domestic) and non-German (foreign) pension plans and the plan assets as of 30 September 2021 and 2020 is presented in the following table:

€ in millions	2021			2020		
	Domestic plans	Foreign plans	Total	Domestic plans	Foreign plans	Total
Change in defined benefit obligations taking into account future salary increases:						
Present value at beginning of year	(1,217)	(221)	(1,438)	(1,219)	(197)	(1,416)
Current service cost	(31)	(8)	(39)	(32)	(6)	(38)
Past service income (cost)	-	1	1	-	-	-
Interest cost	(11)	(4)	(15)	(7)	(4)	(11)
Actuarial gains (losses) for:						
Experience adjustments	20	(1)	19	(58)	(5)	(63)
Adjustments to demographic assumptions	-	-	-	-	1	1
Adjustments to financial assumptions	60	6	66	81	(5)	76
Effects from acquisitions	-	-	-	-	(20)	(20)
Plan settlements	-	3	3	-	-	-
Benefits paid	22	9	31	22	9	31
Employee contributions	(4)	-	(4)	(4)	-	(4)
Foreign currency effects	-	(5)	(5)	-	6	6
Present value of defined benefit obligation at end of year	(1,161)	(220)	(1,381)	(1,217)	(221)	(1,438)
Change in fair value of plan assets:						
Fair value of plan assets at beginning of year	614	85	699	600	83	683
Expected return on plan assets	6	2	8	4	2	6
Actuarial gains (losses)	49	5	54	10	1	11
Acquisitions	-	-	-	-	3	3
Contributions from Infineon	20	8	28	18	8	26
Employee contributions	4	-	4	4	-	4
Benefits paid	(22)	(9)	(31)	(22)	(9)	(31)
Foreign currency effects	-	2	2	-	(3)	(3)
Fair value of plan assets at end of year	671	93	764	614	85	699
Net pension liability	(490)	(127)	(617)	(603)	(136)	(739)
thereof: Infineon Technologies AG	(447)	-	(447)	(552)	-	(552)
thereof: Infineon Technologies Austria AG	-	(58)	(58)	-	(64)	(64)

Pension obligations are reported in the Consolidated Statement of Financial Position under “Pensions and similar commitments”. [p. 154](#)

Since no asset ceilings applied, the funded status of the Infineon pension plans corresponded to the amounts reported in the Consolidated Statement of Financial Position as of 30 September 2021 and 2020.

The funding of the defined benefit obligations as of 30 September 2021 and 2020 was as follows:

€ in millions	30 September 2021			30 September 2020		
	Domestic plans	Foreign plans	Total	Domestic plans	Foreign plans	Total
Plans that are wholly unfunded	8	95	103	9	104	113
Plans that are wholly or partly funded	1,153	125	1,278	1,208	117	1,325
Total	1,161	220	1,381	1,217	221	1,438

Actuarial assumptions

The weighted-average assumptions used in calculating the actuarial values for the pension plans were as follows:

in %	30 September 2021		30 September 2020	
	Domestic plans	Foreign plans	Domestic plans	Foreign plans
Discount rate at the end of the fiscal year	1.3	2.4	1.0	2.0
Rate of salary increase	2.0	4.3	2.0	4.6
Projected future pension increases	1.8	2.8	1.8	2.1

In order to determine the present value as of the balance sheet date, the Willis Towers Watson RATE:Link approach was applied, which is based on high-grade fixed-interest corporate bonds from issuers carrying a very high credit rating, with the same maturity and in the same currency as the pension obligations to be assessed.

The 2018 G mortality tables by Dr. Klaus Heubeck were used for Germany as in the previous year, and for Austria, the AVÖ 2018-P tables were applied.

Sensitivity analysis

The following sensitivity analysis table shows how the present value of all defined benefit pension obligations would be affected by changes in the aforementioned actuarial assumptions. In each case, they reflect the effect of changes in one actuarial assumption while all other assumptions remain constant.

€ in millions	30 September 2021			30 September 2020		
	Domestic plans	Foreign plans	Total	Domestic plans	Foreign plans	Total
Present value of defined benefit pension plans with:						
a 50 basis points higher discount rate	1,072	205	1,277	1,116	206	1,322
a 50 basis points lower discount rate	1,264	235	1,499	1,333	236	1,569
a 50 basis points higher expected rate of salary increase	1,170	225	1,395	1,224	228	1,452
a 50 basis points lower expected rate of salary increase	1,154	215	1,369	1,206	217	1,423
a 50 basis points higher expected rate of pension increase	1,207	225	1,432	1,266	228	1,494
a 50 basis points lower expected rate of pension increase	1,121	214	1,335	1,169	218	1,387
Increase in life expectancy by one year	1,198	224	1,422	1,258	224	1,482

Investment strategy

The pension plans' assets are invested with several fund managers. The investment guidelines require a mix of active and passive investment management programs covering different asset classes. Taking the duration of the underlying liabilities into account, a portfolio of investments of plan assets in equity, debt and other securities, as well as real estate and reinsurance policies, is targeted to maximize the total long-term return on assets for a given level of risk. Investment risk is monitored on an ongoing basis through periodic portfolio reviews, by coordination with investment managers and annual liability measurements. Investment policies and strategies are periodically reviewed as part of detailed studies of assets and liabilities by independent investment advisors and actuaries to ensure the objectives of the plans are met, taking into account any changes in benefit plan structure, market conditions or other material items. The aim is to optimize the risk-return profile of plan assets against the liabilities using a diversified portfolio of investments within a defined risk budget and to thereby increase the funding ratio in the long term.

Plan asset allocation

As of 30 September 2021 and 2020, the allocation of invested plan assets to the major asset categories was as follows:

€ in millions	30 September 2021		30 September 2020	
	Quoted in an active market	Not quoted in an active market	Quoted in an active market	Not quoted in an active market
Government bonds	118	1	208	1
Corporate bonds	236	-	117	-
Equity securities	275	-	213	-
Cash and cash equivalents	8	-	19	-
Reinsurance policies	-	37	-	36
Property	3	30	5	30
Other	32	24	44	26
Total	672	92	606	93

Government and corporate bonds are traded in liquid markets and the majority of them have an investment grade rating. The geographical allocation of the equity component of plan assets is predominantly based on the MSCI World Index. As a matter of policy Infineon's pension plans do not invest in shares or debt instruments of Infineon. The position "Other" in the table above comprises exchange-traded commodities (ETC) and other investment funds. The market value of the ETC held domestically was €31 million as of 30 September 2021 (previous year: €33 million).

The market value of the land and real estate leased to Group companies by the legally independent pension trust amounted to €30 million as of both 30 September 2021 and 2020.

The actual return on plan assets in the fiscal year ended 30 September 2021 was €61 million (30 September 2020: €17 million).

Amounts recognized in the Consolidated Statement of Profit or Loss and in the Consolidated Statement of Comprehensive Income

The expenses and income of defined benefit plans for the 2021 and 2020 fiscal years comprised the following:

€ in millions	2021			2020		
	Domestic plans	Foreign plans	Total	Domestic plans	Foreign plans	Total
Current service cost	(31)	(8)	(39)	(32)	(6)	(38)
Past service (cost) benefit	-	1	1	-	-	-
Interest cost	(11)	(4)	(15)	(7)	(4)	(11)
Expected return on plan assets	6	2	8	4	2	6
Pension cost	(36)	(9)	(45)	(35)	(8)	(43)

Service costs were recorded within cost of goods sold to the extent that they relate to production employees; otherwise they are recorded as research and development or selling, general and administrative expenses. Interest costs and expected return on plan assets were recorded net as part of financial expenses.

Actuarial gains before taxes of €139 million and €25 million for the 2021 and 2020 fiscal years, respectively, had been recognized outside profit (loss) for the period in other comprehensive income.

As of 30 September 2021 and 2020, cumulative actuarial losses amounted to €403 million and €542 million, respectively.

In the 2022 fiscal year, payments of €30 million are expected to be made to plan assets, of which €27 million relate to benefits paid directly to pension recipients by the Group companies.

The weighted-average duration of defined benefit plans was around 17 and 18 years as of 30 September 2021 and 2020, respectively.

The following table shows the expected disbursements for defined benefit plans for the next ten fiscal years as of 30 September 2021 and 2020:

€ in millions	30 September 2021	30 September 2020
Due within one year	38	40
Due after more than one year to five years	172	177
Due after more than five years up to ten years	282	303
Total	492	520

Defined contribution plans

In connection with defined contribution plans, fixed contributions are made to external insurance providers or funds. Infineon has no further performance obligations or risks with regard to these pension plans in excess of the fixed contributions paid. Additionally, the Group makes contributions to government pension schemes. Expenses for defined contribution plans amounted to €234 million and €212 million in the 2021 and 2020 fiscal years.

19 Equity

Ordinary share capital

The following table shows a reconciliation of the number of ordinary shares issued as of 30 September 2021 and 2020:

quantity	2021	2020
Shares outstanding at the beginning of the fiscal year	1,300,669,746	1,244,684,071
Creation of new shares through capital increase from authorized capital	-	55,000,000
Creation of new shares through the exercise of option rights under stock option plans	-	237,066
Transfer of own shares under the Performance Share and Restricted Stock Unit Plans (see note 21, p. 195 ff.)	705,789	748,609
Shares outstanding at the end of the fiscal year	1,301,375,535	1,300,669,746
Repurchased own shares	4,545,602	5,251,391
Shares issued at the end of the fiscal year	1,305,921,137	1,305,921,137

As of 30 September 2021, the ordinary share capital amounted to €2,611,842,274 and was fully paid up. It was divided into 1,305,921,137 no par value registered shares, each representing €2 of the Company's ordinary share capital. Each share grants the holder one vote and an equal portion of the profits in the form of a dividend as resolved by the Annual General Meeting. Own shares held by the Company as of the date of the Annual General Meeting carry no voting rights and are not entitled to a dividend.

Additional paid-in capital

The pro rata expense for share-based payment resulted in an increase in additional paid-in capital of €27 million in the 2021 fiscal year (2020: €14 million). Due to the transfer of own shares to employees and members of the Management Board, additional paid-in capital, as well as the line item for own shares, decreased by €5 million (2020: €4 million). Tax effects totaling €29 million (2020: €22 million) increased the additional paid-in capital. In the previous year, the issue of 55,000,000 new shares resulted in a significant increase in additional paid-in capital of €934 million.

Authorized share capital

As of 30 September 2021, the Company's Articles of Associations provided for two authorized share capitals amounting to up to €670,000,000:

- › Section 4 paragraph 4 of the Articles of Association provides that the Management Board is authorized, with the approval of the Supervisory Board, to increase the share capital in the period until 19 February 2025 once or in several partial amounts by a total of up to €640,000,000 through the issue of new no par value registered shares, against contributions in cash or in kind (Authorized Capital 2020/I). The new shares participate in profits from the beginning of the fiscal year of their issue. To the extent legally permissible, the Management Board may, with the approval of the Supervisory Board, and contrary to section 60 paragraph 2 of the German Stock Corporation Act, stipulate that the new shares participate in the profits from the beginning of an already ended fiscal year for which no resolution of the Annual General Meeting on the use of the distributable profit has yet been made at the time of their issue. The originally authorized capital 2020/I, of €750,000,000 was reduced to €640,000,000 by the capital increase of €110,000,000 as decided by the Management Board and the Supervisory Board on 26 May 2020 and entered in the Commercial Register on 27 May 2020. Within the framework of the Authorized Capital 2020/I, the Management Board is authorized, with the approval of the Supervisory Board, to exclude the subscription rights of the shareholders in certain cases. Cash capital increases with subscription rights excluded pursuant to section 186, paragraph 3, sentence 4, of the German Stock Corporation Act, are not permitted to exceed 10 percent of a company's share capital – neither at the time of the resolution of the authorization in the Annual General Meeting, nor at the effective date of the authorization, or its exercise. The capital increase of 26/27 May 2020 utilized around 4 percent of this framework. For share capital increases against contributions in kind or a combination of cash contributions and contributions in kind, the authorization further provides an upper limit of 10 percent of the share capital in place at the date of the authorization in the Annual General Meeting.
- › Section 4, paragraph 7, of the Articles of Association provides that the Management Board is authorized, with the approval of the Supervisory Board, to increase the share capital in the period up to 24 February 2026 – either once or in partial amounts – by a total of up to €30,000,000 by issuing new no par value registered

shares against contributions in cash for the purpose of increasing the issue to employees and members of the Executive Board of the Company or its Group companies. The subscription rights of the shareholders are excluded in relation to these shares. The shares may be issued to employees in such a manner that the contribution to be paid on such shares is covered by the portion of the profit for the year that the Management Board and Supervisory Board could transfer to retained earnings in accordance with section 58, paragraph 2 of the German Stock Corporation Act. The Management Board, with the approval of the Supervisory Board, decides on the additional content of the share rights and the conditions of share issue (Authorized Capital 2021/I).

Conditional capital

As of 30 September 2021, the Company's Articles of Associations provided for a conditional capital amounting to up to €260,000,000:

- › Pursuant to section 4, paragraph 6, of the Articles of Association the share capital is conditionally increased by up to €260,000,000 through the issue of up to 130,000,000 new no par value registered shares for the granting of shares to creditors or the holders of warrants or convertible bonds, which due to the authorization by the Annual General Meeting on 20 February 2020 are issued by the Company or a subsidiary company (Conditional Capital 2020/1).

Hybrid capital

Infineon Technologies AG issued a perpetual hybrid bond on 1 October 2019 to refinance the acquisition of Cypress, which is an equity instrument under IAS 32. The term is not contractually limited; the bond has no final maturity date. The hybrid bond can only be canceled by Infineon subject to certain conditions. The investors have no cancellation rights and cannot trigger a premature repayment liability for Infineon. Distributions are at Infineon's sole discretion.

In the 2021 fiscal year, €39 million (2020: €39 million) was recognized in equity as compensation to hybrid capital investors. For the purpose of calculating earnings per share, the profit (loss) for the period attributable to the shareholders and hybrid capital investors of Infineon Technologies AG of €1,169 million (2020: €368 million)

was reduced by compensation to the hybrid capital investors of €26 million (2020: €35 million; net of tax), to €1,143 million (2020: €333 million) (see note 7, [p. 176 f.](#)).

The hybrid capital investors' compensation is paid annually in arrears on 1 April of each year, subject to repayment or redemption. On 1 April 2021, €39 million (2020: €20 million) was paid out to the hybrid capital investors.

Retained earnings

The following table shows a reconciliation of retained earnings as of 30 September 2021 and 2020:

€ in millions	
As of 1 October 2019	421
Profit (loss) for the period attributable to shareholders and hybrid capital investors of Infineon Technologies AG	368
Dividends to shareholders of Infineon Technologies AG	(336)
Compensation of hybrid capital investors	(39)
Actuarial gains on pensions and similar commitments net of tax of €6 million	21
As of 30 September 2020	435
Profit (loss) for the period attributable to shareholders and hybrid capital investors of Infineon Technologies AG	1,169
Dividends to shareholders of Infineon Technologies AG	(286)
Compensation of hybrid capital investors	(39)
Actuarial gains on pensions and similar commitments net of tax of €11 million	128
As of 30 September 2021	1,407

“Actuarial gains on pensions and similar commitments” contain the share of profit (loss) of associates and joint ventures accounted for using the equity method in the 2021 fiscal year of €0 million (2020: losses €0 million).

Dividends

For the 2020 fiscal year, a cash dividend of €0.22 per share (total amount: €286 million) was paid. For the 2019 fiscal year, a cash dividend of €0.27 per share (total amount: €336 million) was paid.

With regard to the 2021 fiscal year, a dividend of €0.27 for each share entitled to a dividend shall be proposed to be paid from the €353 million of distributable profits of Infineon Technologies AG. This would result in an expected distribution of approximately €351 million. The payment of this dividend depends on the approval of the Annual General Meeting on 17 February 2022.

Other reserves

Changes in other reserves during the 2021 and 2020 fiscal years were as follows:

€ in millions	2021			2020		
	Pre-tax	Tax	Net of tax	Pre-tax	Tax	Net of tax
Foreign currency translation differences	90	–	90	(543)	–	(543)
Unrealized gains (losses) resulting from hedge accounting	(1)	–	(1)	(71)	–	(71)
Realized gains (losses) resulting from hedge accounting	48	17	65	(170)	28	(142)
Cost of hedging	–	–	–	42	–	42
Total	137	17	154	(742)	28	(714)

20 Capital management

Infineon's main capital management objective is to ensure financial flexibility on the basis of a solid capital structure. It is of prime importance that sufficient cash funds are available to finance operating activities and planned investments throughout all phases of the business cycle. On the other hand, debt should only constitute a modest portion of the financing mix.

Based on these principles and the intention to retain its investment grade rating, Infineon has derived medium- and long-term key objectives for capital management. For liquidity, the gross cash should amount to €1 billion plus at least 10 percent of revenue. Infineon's gross financial debt is capped at a maximum of two times EBITDA. As a result of the acquisition of Cypress, Infineon has exceeded its gross debt target but only to an extent that was still compatible with maintaining the investment grade rating. The originally medium-term objective of Infineon to reduce its debt level to or below the maximum target value after the closing of the Cypress transaction is expected to be achieved already in the 2022 fiscal year.

Infineon is not subject to any statutory capital requirements, nor are any such defined in the Articles of Association.

Capital management, as well as the corresponding targets and definitions, are based on indicators determined on the basis of the consolidated IFRS financial statements. Gross cash is defined as the total of cash, cash equivalents and financial investments. Gross financial debt comprises short-term and long-term financial debt. Infineon defines EBITDA as earnings (loss) from continuing operations before interest, taxes and depreciation and amortization.

The gross cash position increased from €3,227 million as of 30 September 2020, to €3,922 million as of 30 September 2021 (for details, see the chapter "Review of liquidity" in the Combined Management Report, [p. 107](#)). Based on revenues of €11,060 million, the ratio of gross cash to revenue as of 30 September 2021 was €1 billion, plus an additional 26.4 percent of revenue (previous year: €1 billion plus 26.0 percent of revenue). Cypress has been included in the revenues of the 2020 fiscal year since 16 April 2020.

With gross financial debt of €6,585 million as of 30 September 2021 (30 September 2020: €7,033 million) following the financing of the acquisition of Cypress, and EBITDA of €2,982 million for the 2021 fiscal year (2020: €1,785 million), the gross debt to EBITDA ratio was 2.2 as of 30 September 2021 (30 September 2020: 3.9). Cypress has

been included in the EBITDA of the 2020 fiscal year since 16 April 2020. Infineon continues to have sufficient financial flexibility to ensure that, in addition to financing its planned investments, it is also able to pay regular dividends (see note 19, [p. 193 f.](#)).

The USPP notes totaling US\$2,235 million issued in April 2016 and June 2021 contain a number of standard covenants, including a debt coverage ratio, which provides for a certain relationship between the size of debt (adjusted) and earnings (adjusted).

In the 2021 fiscal year, Infineon had met the minimum requirements of all covenants. Should Infineon not comply with the covenants attached to the USPP notes, then all USPP notes outstanding as of 30 September 2021 amounting to US\$2,235 million (see note 15, [p. 184](#)) could become immediately repayable.

21 Share-based payment

The Company makes use of the Performance Share Plan and, since the 2017 fiscal year, the Restricted Stock Unit Plan, in order to provide share-based payments.

Performance share plan

A Long-Term Incentive (LTI) Plan, the so-called Performance Share Plan, was developed for the Management Board and selected senior executives.

Under this plan, (virtual) performance shares are initially provisionally granted on 1 April (up to the 2020 fiscal year: 1 March) of the fiscal year according to a predetermined LTI grant amount in euros.

Plan conditions for tranches up to and including 1 March 2020

With the granting of a virtual performance share, the participants in the plan acquire the right to receive (real) Infineon shares once a personal investment in Infineon shares – depending on position and LTI grant amount – has reached a four-year holding period.

For the tranches up to and including 1 March 2020, the performance shares were split between 50 percent performance-related shares and 50 percent that were not dependent on performance. The performance-related shares were finally granted only when the Infineon share outperformed the Philadelphia Semiconductor Index (SOX) during the period between the date of the provisional allocation and the end of the vesting period. If at the end of the vesting period the requirements for an allocation of performance shares – either all or only those that are not performance-related – were fulfilled, then entitlement to the transfer of the corresponding number of (real) Infineon shares was acquired. The value of the performance shares ultimately assigned to members of the Management Board could not exceed 250 percent of the respective LTI grant amount; above this cap, performance shares lapse.

The fair value of the performance shares at the date of allocation was determined by an external expert using a recognized financial-mathematical method (Monte Carlo simulation model for the prediction of share price and index developments). The fair value of the instruments granted was determined, taking into account future dividends as well as the payment cap.

The following is an overview of the allocations made:

Tranche	End of the waiting period	Average share price in the nine months before grant in €	Number of performance shares outstanding as of 30 September 2021	Fair value per performance share in €
Fiscal year 2020: Employees	29 February 2024	18.10	1,007,326	12.95
Fiscal year 2020: Management Board	29 February 2024	18.10	70,850	12.50
Fiscal year 2019: Employees	28 February 2023	20.02	713,184	14.20
Fiscal year 2019: Management Board	28 February 2023	20.02	44,954	13.79
Fiscal year 2018: Employees	28 February 2022	21.48	646,882	15.76
Fiscal year 2018: Management Board	28 February 2022	21.48	41,896	15.25

Plan conditions for tranches from 1 April 2021

With the granting of a virtual performance share, the participant in the plan acquires the right to receive (real) Infineon shares once a personal investment in Infineon shares – depending on position and LTI grant amount – has reached a four-year holding period. The number of real Infineon shares to be transferred depends on the achievement of targets during the performance period.

The performance period begins on 1 October of the first fiscal year of the performance period and ends four years later on 30 September. Performance during the performance period is measured using the relative total shareholder return (TSR) financial performance criterion compared to companies in a selected industry peer group, together with non-financial performance criterion comprising strategy-derived environmental, social & governance (ESG) objectives. The TSR target accounts for 80 percent and the ESG 20 percent of the overall target achievement. TSR and the ESG target achievements can be between 0 percent and 150 percent.

The tranche is granted on 1 April in the first fiscal year of the performance period (allocation day). The vesting period begins on the allocation day. In contrast to the performance period, the vesting period ends four years after the allocation day, i.e., on 31 March. At the end of the four-year performance period, the target achievement is determined.

The final number of performance shares to be allocated after the expiry of the vesting period is determined by multiplying the number of provisionally allocated performance shares by the overall target achievement of the two performance criteria during the performance period. The final allocation of the performance shares within an LTI tranche may not result in a profit (before tax) of more than 250 percent of the respective LTI grant amount; above this cap, all performance shares still to be allocated lapse.

The fair value of the performance shares at the date of allocation was determined by an external expert using a recognized financial-mathematical method (Monte Carlo simulation model for the prediction of the TSR target achievements). The fair value of the instruments granted is determined taking into account future dividends as well as the payment cap.

The following is an overview of the allocations made:

Tranche	End of the waiting period	Average share price in the 60 trading days before the start of the performance period in €	Number of performance shares outstanding as of 30 September 2021	Fair value per performance share in €
Fiscal year 2021: Employees	31 March 2025	22.82	572,631	28.87
Fiscal year 2021: Management Board	31 March 2025	22.82	178,213	28.87

Restricted Stock Unit Plan

The Restricted Stock Unit Plan (RSUP) was introduced in the 2017 fiscal year.

Under this plan, (virtual) restricted stock units are initially provisionally granted on 1 April (up to the 2020 fiscal year: 1 March) of the fiscal year according to a pre-determined LTI grant amount in euros. With the allocation of a (virtual) restricted stock unit, the plan participant acquires the right to receive a (real) Infineon share after the expiry of the vesting period, provided that the employee is still employed by Infineon at this time. The final allocation is made in stages (each representing 25 percent of the provisionally allocated restricted stock units) after the expiry of the vesting period of one year following allocation.

The fair value of the restricted stock units at the date of allocation was determined by an external expert using a recognized financial-mathematical method (Monte Carlo simulation model for the prediction of share price developments). The fair value of the instruments granted is determined, taking into account future dividends.

The following is an overview of the allocations made:

Tranche	End of the waiting period	Price of an Infineon share at grant date in €	Number of restricted stock units as of 30 September 2021	Fair value per restricted stock unit in €
Fiscal year 2021:				
1st tranche	31 March 2022	36.16	346,715	35.90
2nd tranche	31 March 2023	36.16	346,715	35.60
3rd tranche	31 March 2024	36.16	346,715	35.29
4th tranche	31 March 2025	36.16	346,715	34.87
Fiscal year 2020:				
2nd tranche	28 February 2022	18.62	79,043	17.98
3rd tranche	28 February 2023	18.62	79,043	17.65
4th tranche	29 February 2024	18.62	79,043	17.31
Fiscal year 2019:				
3rd tranche	28 February 2022	19.66	58,765	18.84
4th tranche	28 February 2023	19.66	58,765	18.58
Fiscal year 2018:				
4th tranche	28 February 2022	21.80	41,953	20.87

The tranches due in February and March 2021, respectively, were fulfilled in shares. 244,804 Infineon shares were issued to eligible employees from the holding of own shares.

Costs for share-based payment

The costs for share-based payment amounted to €27 million in the 2021 fiscal year (2020: €14 million).

22 Other financial commitments

In addition to provisions and liabilities, there were other financial obligations that were not recognized in the Consolidated Statement of Financial Position. These result, in particular, from unconditional purchase commitments, which are explained in more detail below.

Contracts already entered into for commenced or planned investments in property, plant and equipment (purchase commitments) as of 30 September 2021 amounted to €894 million (30 September 2020: €435 million).

In the course of its investing activities, Infineon also receives government grants related to the construction and financing of certain of its manufacturing facilities. Grants are also received for selected research and development projects. Certain grants have been received contingent upon Infineon complying with particular project-related requirements, such as creating a specified number of jobs over a defined period of time. From today's perspective, Infineon expects to comply with these requirements. Nevertheless, should such requirements not be met, as of 30 September 2021, a maximum of €236 million (30 September 2020: €200 million) of subsidies already received could be refundable.

Through certain sales and other agreements, Infineon may be obligated in the normal course of business to indemnify its counterparties under certain conditions for warranties, patent infringement or other matters. The maximum amount of potential future payments under these types of agreements is not predictable with any degree of certainty, since the potential obligations are contingent on events that may or may not occur in the future and depend on certain facts and circumstances specific to each agreement. Historically, payments made by Infineon under these types of agreements have not had a material adverse effect on Infineon's financial condition, liquidity position and results of operations.

23 Legal risks

Litigation and government inquiries

Smart card chips antitrust litigation

In October 2008, the EU Commission initiated an investigation into the Company and other manufacturers of chips for smart cards for alleged violations of antitrust laws. In September 2014, the EU Commission imposed a fine of €83 million on Infineon, which in July 2020 was reduced to €76.9 million by the General Court of the European Union.

In July 2019, a direct customer filed a lawsuit against Infineon Technologies UK Limited and several Renesas entities in London (United Kingdom) relating to the aforementioned EU antitrust case.

Any further statements about this matter by the Company could seriously compromise the Company's position in this dispute.

Proceedings in relation to Qimonda

All significant assets, liabilities and business activities attributable to the memory business (Memory Products) were carved out from Infineon and transferred to Qimonda in the form of a contribution in kind with economic effect from 1 May 2006. Qimonda filed an application at the Munich Local Court to commence insolvency proceedings on 23 January 2009. On 1 April 2009, the insolvency proceedings formally opened. The insolvency of Qimonda has given rise to various disputes between the insolvency administrator and Infineon.

Alleged activation of a shell company and liability for impairment of capital

The insolvency administrator filed a request for declaratory judgment in an unspecified amount against Infineon Technologies AG and, by way of third-party notice, Infineon Technologies Holding B.V. and Infineon Technologies Investment B.V., at Regional Court Munich I in November 2010. This requested that Infineon be deemed liable to make good the deficit balance of Qimonda as it stood when the insolvency proceedings in respect of the assets of Qimonda began, i.e., to refund to Qimonda the difference between the latter's actual business assets when the insolvency proceedings began and its share capital (in German: "Unterbilanzhaftung"). The insolvency administrator contended that the commencement of operating activities by Qimonda

amounted to what is considered in case law to be the activation of a shell company (in German: "Wirtschaftliche Neugründung"), and that this activation of a shell company was not disclosed in the correct manner. On 6 March 2012, with respect to another matter, the German Federal High Court issued a ruling on principle that any liability resulting from the activation of a shell company only depends on the situation at the date of the activation of a shell company and not, as asserted by the insolvency administrator, on the situation at the date on which insolvency proceedings are opened.

In addition to the request for declaratory judgment against Infineon in an unspecified amount, on 14 February 2012 the insolvency administrator also lodged a request for payment based on an alternative claim (in German: "Hilfsantrag"), as well as making other additional claims. In conjunction with this alternative claim, the insolvency administrator has requested the payment of at least €1.71 billion plus interest in connection with the alleged activation of a shell company. On 15 June 2012, the insolvency administrator increased his request for the payment of 14 February 2012 on the grounds of activation of a shell company to at least approximately €3.35 billion plus interest. Furthermore, the insolvency administrator continues to base a substantial part of his alleged payment claims, as already asserted out of court against Infineon in August 2011 for an unspecified amount, on liability for impairment of capital (in German: "Differenzhaftung"). This claim is based on the allegation that, from the very beginning, the carved-out memory products business had a negative billion euro value. The insolvency administrator therefore asserts that Infineon is obliged to make good the difference between this negative value and the lowest issue price (in German: "geringster Ausgabebetrag") of the subscribed stock. Additionally, the insolvency administrator has asserted a claim for repayment of allegedly unjustly charged consultancy fees in an amount of €10 million in connection with the flotation of Qimonda.

The alleged impairment of capital runs contrary to two valuations prepared as part of the preparatory documentation for the capital increase by independent auditing companies, one of which had been engaged by Infineon and the other of which was acting in the capacity of a court-appointed auditor of contributions in kind and post-formation acquisitions. The auditing company engaged by Infineon concluded in its valuation that the business area contributed had a value of several times the lowest issue price of the shares issued, while the court-appointed auditor of contributions in kind and post-formation acquisitions confirmed to the court that the lowest

issue price of the shares issued was covered – as legally required – by the value of the contributions in kind. Additionally, in the course of its defense against the claims asserted by the insolvency administrator, Infineon has commissioned several expert opinions, all of which arrived at the same conclusion that the objections raised by the insolvency administrator against the valuation of the contribution in kind are not valid.

The legal dispute has, in the meantime, focused on the claims asserted for alleged lack of value. On 29 August 2013, the court appointed an independent expert to clarify the valuation issues raised by the insolvency administrator and to address technical matters.

The legal dispute is being pursued with great effort by both parties, and many extensive written submissions have already been exchanged between the parties. Both sides have engaged numerous specialists and experts who are supporting the respective parties with assessments and opinions.

On 21 September 2018, in consultation with the parties, the independent expert appointed by the court presented an interim report on his preliminary assessment of the value of the contribution in kind. The Company is in principle prepared to conduct discussions about an out-of-court settlement of the legal dispute on the basis of the interim report.

The parties are exchanging further written submissions. It is not clear at this stage if the legal dispute can be resolved with an out-of-court settlement, and, if this is not the case, when a first-instance court decision would be reached.

Residual liability of Infineon as former shareholder of Qimonda Dresden GmbH & Co. OHG

Infineon was a shareholder with personal liability of Qimonda Dresden until the carve-out of the memory business; as a result, certain long-standing creditors have

residual liability claims against Infineon. These claims can only be exercised by the insolvency administrator acting in the name of the creditors concerned. In the meantime, settlements have been concluded with most of the major liability creditors.

Liabilities, provisions and contingent liabilities relating to Qimonda

Infineon recognizes provisions and liabilities for such obligations and risks, which it assesses at the end of each reporting period, are more likely than not to be incurred (that is where, from Infineon's perspective at the end of each reporting period, the probability of having to settle an obligation or risk is greater than the probability of not having to) and the obligation or risk can be estimated with reasonable accuracy at this time.

As described above, Infineon faces certain risks in connection with the insolvency proceedings relating to the assets of Qimonda and that entity's subsidiaries. In consideration of the interim report from the court-appointed expert, Infineon recorded provisions relating to Qimonda of €211 million in total as of 30 September 2021. This comprises mainly provisions for the still pending legal dispute over the alleged activation of a shell company and liability for impairment of capital, including legal costs. As of 30 September 2020, provisions relating to Qimonda amounted to €206 million.

There can be no certainty that the provisions recorded for Qimonda will be sufficient to cover all of the liabilities that could ultimately be incurred in relation to the insolvency of Qimonda and, in particular, the matters discussed above. In addition, it is possible that liabilities and risks materialize that are currently considered to be unlikely to do so and, accordingly, represent contingent liabilities that are not included in provisions. Should the alleged claims relating to the activation of a shell company and liability for impairment of capital prove to be valid, substantial financial obligations above the provisions already recorded could arise for Infineon, which could have a material adverse effect on its business and its financial condition, liquidity position and results of operations.

Other

Infineon is also involved in various other legal disputes and proceedings in connection with its existing or previous business activities. These can relate, in particular, to products, services, patents, export control and environmental issues and other matters.

Based on its current knowledge, Infineon does not believe that the ultimate resolution of these other pending legal disputes and proceedings will have a material adverse effect on Infineon's financial condition, liquidity position and results of operations. However, future revisions to this assessment cannot be ruled out, and any reassessment of the miscellaneous legal disputes and proceedings could have a material adverse effect on the financial condition, liquidity position and results of operations, particularly in the period in which reassessment is made.

Furthermore, in connection with its existing or previous business operations, Infineon is also exposed to numerous legal risks, which have until now not resulted in legal disputes. These include risks related to product liability, environment, capital market, anti-corruption, competition and antitrust legislation as well as export control and other compliance regulations. Claims could also be made against Infineon in connection with these matters in the event of breaches of law committed by individual employees or third parties.

As part of an audit finding relating to the tax treatment of losses from the repurchase of convertible bonds in the 2011 and 2012 fiscal years, as of 30 September 2021 and 2020, there was a contingent liability of €55 million for withholding tax payables plus interest. Suspension of enforcement has been granted under the current appeal procedure. Infineon expects that there is a sufficient likelihood of winning any potential appeal or legal action.

Provisions and contingent liabilities for legal proceedings and other uncertain legal issues

Provisions relating to legal proceedings and other uncertain legal issues are recorded when it is probable that a liability has been incurred and the associated amount can

be reasonably estimated. To the extent that liabilities arising from legal disputes and other uncertain legal positions are not probable or cannot be reliably estimated, then they qualify as contingent liabilities.

Any potential liability is reviewed again as soon as additional information becomes available and the estimates are revised if necessary. Provisions with respect to these matters are subject to future developments or changes in circumstances in each of the matters, which could have a material adverse effect on Infineon's financial condition, liquidity position and results of operations.

A settlement or adverse judicial decision in any of the matters described above could result in significant financial liabilities for Infineon and other adverse effects, and these in turn could have a material adverse effect on its business and financial condition, liquidity position and results of operations. Irrespective of the validity of the allegations and the success of the aforementioned claims and other matters described above, Infineon could incur significant costs in the defense of these matters.

24 Transactions with related companies and persons

Infineon has transactions in the normal course of business with joint ventures, associates and other related companies (collectively "related companies"). The related companies are disclosed in note 29, [p. 225 ff.](#) Related persons are persons in key management positions, in particular members of the Management and Supervisory Board (see note 29, [p. 222 f.](#)) and their close relatives (collectively "related persons").

Related companies

Infineon purchases certain raw materials and services from and sells certain products and services to related companies. These purchases from and sales to related companies are generally effected at arm's length.

Related companies receivables and payables as of 30 September 2021 and 2020 consisted of the following:

€ in millions	30 September 2021			30 September 2020		
	Joint ventures	Associates	Other related companies	Joint ventures	Associates	Other related companies
Trade and other receivables	6	3	–	4	5	–
Financial receivables	33	1	–	32	–	1
Trade and other payables	7	–	2	9	–	1
Financial payables	–	–	2	–	–	1

Sales and service charges to and products and services received from related companies in the 2021 and 2020 fiscal years consisted of the following:

€ in millions	2021			2020		
	Joint ventures	Associates	Other related companies	Joint ventures	Associates	Other related companies
Sales and service charges	75	18	3	29	5	2
Products and services received	80	–	20	75	–	17

As of 30 September 2021, sales and services relationships with related companies resulted in purchase commitments of €22 million (30 September 2020: €4 million).

Related persons

Members of the Management Board active in the 2021 fiscal year received fixed non-performance-related remuneration for their services of €4.1 million (2020: €3.8 million). In addition, the members of the Management Board received variable performance-related remuneration for their services in the 2021 fiscal year of €8.6 million (2020: €3.6 million). This comprised a Short-Term Incentive of €3.4 million (2020: €1.4 million), and a Mid-Term Incentive of €0 million (2020: €1.3 million). Furthermore, the Management Board received a Long-Term Incentive (LTI) which, since 2014, takes the form of performance shares. The expense resulting from the LTI amounted to €5.1 million (2020: €0.9 million). The remuneration granted to active members of the Management Board amounted to €12.7 million in the 2021 fiscal year (2020: €7.3 million).

The remuneration of the members of the Supervisory Board of Infineon Technologies AG in the 2021 fiscal year, including attendance fees, amounted to €2.1 million (2020: €2.1 million). Employee representatives in the Supervisory Board who are employed by Infineon also receive a salary for their activities as employees.

Former members of the Management Board received payments (in particular pension payments) of €2.6 million in the 2021 fiscal year (2020: €2.2 million).

As of 30 September 2021, pension obligations for former members amounted to €72.4 million (30 September 2020: €76.6 million).

Disclosure of the individual remuneration of the members of the Management Board and the Supervisory Board as required by section 315e, paragraph 1, in connection with section 314, paragraph 1, no. 6a, sentences 5 to 8, of the German Commercial Code (version before ARUG II), is provided in the remuneration report which is part of the Combined Management Report. [p. 132 ff.](#)

In the 2021 and 2020 fiscal years, there were no significant transactions between Infineon and related persons which fall outside of the scope of the existing employment, service or appointment terms, or of the contractual arrangements for their remuneration.

25 Supplemental cash flow information

Cash and cash equivalents reported as of 30 September 2021 and 2020 totaling €1,749 million and €1,851 million, respectively, included €104 million and €77 million, respectively, which were subject to legal transfer restrictions and so were not available for general use by Infineon. This amount represented cash and cash equivalents of consolidated companies located in countries where the transfer of cash is legally restricted, for example China.

The reconciliation below shows changes in those financial liabilities and hedging transactions for which payments received and made are shown under cash flows from financing activities in the statement of cash flows.

€ in millions	Starting balance	Cash-effective changes	Non-cash effective changes				Ending balance
			Acquisitions ¹	Currency effects	New leases	Other changes	
The 2021 fiscal year							
Short-term and long-term financial debt	7,033	(487)	-	29	-	10	6,585
Related party financial payables	1	1	-	-	-	-	2
Short-term and long-term leasing liabilities	294	(76)	-	3	110	-	331
Total	7,328	(562)	-	32	110	10	6,918
The 2020 fiscal year							
Short-term and long-term financial debt	1,556	4,443	1,335	(306)	-	5	7,033
Related party financial payables	-	1	-	-	-	-	1
Short-term and long-term leasing liabilities	262	(63)	40	(8)	63	-	294
Total	1,818	4,381	1,375	(314)	63	5	7,328

¹ Amounts shown for the 2020 fiscal year as "Acquisitions" related to financial debt acquired in connection with the acquisition of Cypress.

26 Additional disclosures on financial instruments

Categories of financial instruments

The following tables present the carrying amounts and the fair values of financial instruments by their respective classes and a breakdown by category of financial instruments as of 30 September 2021 and 2020 according to IFRS 9:

	Carrying amount	Categories of financial assets		Not assignable to any IFRS 9 measurement category	Fair value
		At fair value through profit or loss	At amortized cost	Designated hedging instruments (cash flow hedges)	
Financial assets, € in millions					
As of 30 September 2021					
Current assets:					
Cash and cash equivalents	1,749	1,456	293	-	1,749
Financial investments	2,173	1,066	1,107	-	2,173
Trade receivables	1,483	-	1,483	-	1,483
Other current assets	156	2	154	-	156
Non-current assets:					
Other non-current assets	193	114	79	-	193
Total	5,754	2,638	3,116	-	5,754
As of 30 September 2020					
Current assets:					
Cash and cash equivalents	1,851	1,524	327	-	1,851
Financial investments	1,376	777	599	-	1,376
Trade receivables	1,196	-	1,196	-	1,196
Other current assets	257	2	254	1	257
Non-current assets:					
Other non-current assets	154	98	56	-	154
Total	4,834	2,401	2,432	1	4,834

	Carrying amount	Categories of financial liabilities				Fair value
		At fair value through profit or loss	Other financial liabilities (amortized cost)	Not assignable to any IFRS 9 measurement category		
				Designated hedging instruments (cash flow hedges)	Others	
Financial liabilities, € in millions						
As of 30 September 2021						
Current liabilities:						
Short-term financial debt and current portion of long-term financial debt	833	143	690	-	-	840
Trade payables	1,569	-	1,569	-	-	1,569
Current leasing liabilities	66	-	-	-	66	-
Other current liabilities	751	5	745	1	-	751
Non-current liabilities:						
Long-term financial debt	5,752	-	5,752	-	-	6,049
Non-current leasing liabilities	265	-	-	-	265	-
Other non-current liabilities	72	-	72	-	-	72
Total	9,308	148	8,828	1	331	9,281
As of 30 September 2020						
Current liabilities:						
Short-term financial debt and current portion of long-term financial debt	505	139	366	-	-	509
Trade payables	1,160	-	1,160	-	-	1,160
Current leasing liabilities	59	-	-	-	59	-
Other current liabilities	845	2	777	66	-	845
Non-current liabilities:						
Long-term financial debt	6,528	-	6,528	-	-	6,783
Non-current leasing liabilities	235	-	-	-	235	-
Other non-current liabilities	77	-	77	-	-	77
Total	9,409	141	8,908	66	294	9,374

Within financial assets measured at amortized cost, financial assets with a carrying amount of €12 million (previous year: €2 million) were included as of 30 September 2021, which Infineon has pledged as collateral for liabilities or contingent liabilities. In addition, €0 million (previous year: €1 million) relating to an agreement in connection with the subsequent liability as shareholder with personal liability of Qimonda Dresden GmbH & Co. OHG (see note 23, [p. 199](#)) was deposited in an escrow account as security against potential claims against Infineon.

In the 2021 and 2020 fiscal years, there were no reclassifications between the categories of financial instruments.

Disclosures about fair value

Financial instruments at amortized cost

For assets allocated to the category “At amortized cost”, it is assumed that the fair values correspond to their carrying amounts. The same assumption applies to liabilities resulting from trade payables and other current liabilities categorized as “Other financial liabilities (amortized cost)”.

The fair value of current and non-current financial debt that is measured at amortized cost is based either on quoted prices as of the reporting date (level 1) or is determined based on expected future cash flows discounted using a current market interest rate (level 2). As of 30 September 2021, short-term financial debt and current portion of long-term financial debt was assigned to level 1 with a fair value of €504 million (previous year: €0 million) and to level 2 with a fair value of €193 million (previous year: €139 million). As of 30 September 2021, fair values of non-current financial debt which were allocated to level 1, amounted to €3,077 million (previous year: €3,521 million). As of 30 September 2021, fair values for level 2 amounted to €2,972 million (previous year: €3,262 million).

Financial instruments at fair value

Financial instruments measured at fair value are allocated to the following measurement levels in accordance with IFRS 13. The allocation to the different levels is based on the market proximity of the valuation parameters used in the determination of the fair values:

- › Level 1: quoted prices (unadjusted) in active markets for identical assets and liabilities,
- › Level 2: valuation parameters whose prices are not the ones considered in Level 1, but which can be observed either directly or indirectly for the assets or liabilities,
- › Level 3: valuation parameters for assets and liabilities, which are not based on observable market data.

The allocation to the levels as of 30 September 2021 and 2020 was as follows:

€ in millions	Fair value	Fair value by category		
		Level 1	Level 2	Level 3
30 September 2021				
Current assets:				
Cash and cash equivalents	1,456	1,456	-	-
Financial investments	1,066	1,066	-	-
Other current assets	2	-	2	-
Non-current assets:				
Other non-current assets	114	94	4	16
Total	2,638	2,616	6	16
Current liabilities:				
Short-term financial debt and current portion of long-term financial debt	143	-	143	-
Other current liabilities	6	-	6	-
Total	149	-	149	-

€ in millions	Fair value	Fair value by category		
		Level 1	Level 2	Level 3
30 September 2020				
Current assets:				
Cash and cash equivalents	1,524	1,524	-	-
Financial investments	777	777	-	-
Other current assets	3	-	3	-
Non-current assets:				
Other non-current assets	98	81	-	17
Total	2,402	2,382	3	17
Current liabilities:				
Short-term financial debt and current portion of long-term financial debt	139	-	139	-
Other current liabilities	68	-	68	-
Total	207	-	207	-

Cash equivalents and financial investments included investments in money market funds and investment funds (level 1).

Other current assets and other current liabilities contained derivative financial instruments (including cash flow hedges to hedge planned raw material purchases). Their fair value was determined by discounting future cash flows according to the discounted cash flow method. Where possible, valuation parameters observed on the reporting date in the relevant markets (such as currency rates, interest rates, or commodity prices) drawn from reliable external market data providers were used (level 2).

Other non-current assets included equity investments and investments in funds. Where these are traded on an active market, the fair value was based on the actual market price (level 1). In addition, other non-current assets included derivative financial

instruments whose fair value was calculated using recognized financial-mathematical models, with only observable input parameters included in the measurement (level 2). For equity investments where no market price from an active market is available, the fair value was determined by considering existing contractual arrangements based on externally observable dividend policy (level 3).

Short-term financial debt included the conversion rights from convertible bonds acquired in the course of the acquisition of Cypress (see note 15, [p. 184 f.](#)), which can be exercised against cash payment by bondholders until the maturity of the instruments. The fair value of the conversion rights was determined by discounting future cash flows according to the discounted cash flow method. Valuation parameters observed on the reporting date in the relevant markets, such as interest rates and US dollar spot rates drawn from reliable external market data providers, were used (level 2).

The following table shows the reconciliation of financial instruments classified as level 3 (before tax):

€ in millions	30 Sep- tember 2020	Sales (including disposals) ²	Unrealized losses recognized in profit or loss ¹	Realized gains recognized in profit or loss ^{1,2}	30 Sep- tember 2021
Equity investments	17	(13)	(1)	13	16
Total	17	(13)	(1)	13	16

¹ This relates to gains recognized in financial income or losses recognized in financial expenses.

² This relates to the sale of an investment acquired in the course of the acquisition of Cypress.

A hypothetical change in the material non-observable valuation parameters at the balance sheet date of ± 10 percent would have resulted in a theoretical reduction in fair values of €1 million or an increase of €1 million (previous year: both €1 million).

Gains and losses in relation to financial instruments

The net gain or loss on financial instruments (including interest income and expense) within continuing operations in the Consolidated Statement of Profit or Loss amounted to the following as of 30 September 2021 and 2020:

€ in millions	2021	2020
Financial assets measured at amortized cost	24	(42)
therein interest income	5	28
therein impairment losses	-	(1)
therein foreign currency exchange	19	(70)
Financial assets measured at fair value through profit and loss	13	(15)
Financial liabilities measured at amortized cost	(177)	(18)
therein interest expenses	(139)	(120)
therein foreign currency exchange	(36)	107
therein other financial expenses	(2)	(5)
Financial liabilities at fair value through profit or loss	(2)	(3)
Financial assets or liabilities measured at fair value through profit and loss - held for trading	3	(40)
therein foreign currency exchange	3	(40)
Total	(139)	(118)

Interest expense on financial liabilities measured at amortized cost mainly included interest on financial debt and effects from using the effective interest method.

Infineon does not net financial instruments. Infineon conducts derivative transactions according to the global netting agreement (Master Agreement) of the International Swaps and Derivatives Association (ISDA) and other comparable national framework agreements. Under the terms of these agreements, any netting arising from the occurrence of certain future events would have had no material effect on the balance sheet presentation of these financial instruments.

Derivative financial instruments and hedging activities

Derivative financial instruments not designated as a hedging relationship

Infineon holds derivative financial instruments exclusively for hedging purposes. This includes the use of forward exchange contracts, foreign currency options, interest- and commodity swaps. The objective is to reduce the impact of exchange rate, interest rate and commodity price fluctuations on future net cash flows.

The nominal values and fair values of Infineon's derivative instruments as of 30 September 2021 and 2020 that were not designated as cash flow hedges were as follows:

€ in millions	30 September 2021		30 September 2020	
	Nominal value	Fair value	Nominal value	Fair value
Forward exchange contracts sold	280	(5)	144	(2)
Forward exchange contracts purchased	236	2	151	2
Total		(3)		-

Derivative financial instruments designated as a hedging relationship

As of 30 September 2021 and 2020, Infineon held the following instruments, which were designated as cash flow hedges and were used to hedge against interest rate and commodity price changes:

	Short term
30 September 2021	
Hedging of other risks	
Commodity swaps	
Nominal value (€ in millions)	21
Average price (US dollar/ounce)	1,813
30 September 2020	
Hedging of interest risks	
Interest rate swaps	
Nominal value (US\$ in millions)	750
Average interest rate	1.9548%
Hedging of other risks	
Commodity swaps	
Nominal value (€ in millions)	15
Average price (US dollar/ounce)	1,765

Hedging of foreign exchange risk

Foreign exchange derivatives are entered into by Infineon to offset the exchange risk from anticipated cash receipts from operating activities. In the 2021 fiscal year, no foreign exchange derivatives were designated as cash flow hedges to hedge the operating activities. In connection with the acquisition of Cypress, foreign exchange derivatives were acquired in the previous year to hedge the operating activities, which were redesignated as cash flow hedges. These foreign currency derivatives expired in full in the previous year.

Hedging of interest risks

In view of future refinancing measures, in December 2019, Infineon partially hedged against the risk of rising interest rates with transaction-dependent interest rate hedging transactions with a total nominal volume of €2,025 million and US\$750 million, which were accounted for as cash flow hedges. For the aforementioned hedging relationships, there was at all times an economic relationship between the hedged item and the hedging instrument (critical term). The hedging ratio was 1:1. As part of the hedging, the swap rates were designated in their volume to 100 percent. On the other hand, the transaction-dependent premium implicit in the swap rates was excluded from the designation of the hedging instrument. The resulting market price deviations from the respective transaction price were capitalized as so-called day one losses and were recognized directly in the Consolidated Statement of Profit or Loss over the term of the hedges until the date of the refinancing measures.

Interest rate swaps with a nominal volume of €2,025 million already matured in the 2020 fiscal year. In the course of the US private placement of the notes in April 2021 (see note 15, [p. 184 f.](#)), the remaining interest rate swaps with a nominal volume of US\$750 million matured on 26 March 2021, resulting in a cash outflow of €23 million. The amounts from this hedging relationship that continue to be recognized in other reserves amounting to negative €19 million will be recognized in interest expense over the term of the individual tranches of the notes. Ineffectiveness of €2 million from the interest rate swaps was recognized in the Consolidated Statement of Profit or Loss in the 2021 fiscal year. This arose as a result of a deviation between the actual and planned credit terms. A further €2 million was related to the transaction-related premium implicit in the swap rates. Of this, €1 million had already been recognized in profit or loss in the previous year.

The development of the day one losses was as follows:

€ in millions	2021	2020
Day one losses at beginning of the fiscal year	1	-
Addition from new transactions	-	11
Reversal through profit or loss in the period	(1)	(10)
Day one losses at end of the fiscal year	-	1

Hedging of other risks

To hedge the price risks of highly probable gold purchases in the 2022 fiscal year, Infineon entered into swaps, which are designated as cash flow hedges. The designated hedged items and the hedging instruments were subject to the same risk. The economic connection was proven by means of a regression analysis. Due to the execution of only highly effective hedging transactions, Infineon assumes that significant ineffective elements will normally not be generated. Infineon applies a hedging ratio of 1:1. Ineffectiveness can be caused mainly from the impact of the credit risks arising from the counterparty and the Company on the fair value of the swap, that is not reflected in the change in the fair value of hedged cash flows attributable to changes in raw material prices. As in the previous year, no hedge ineffectiveness was recorded in the Consolidated Statement of Profit or Loss for these hedging relationships. As in the previous year, no gains or losses were transferred from other reserves to profit or loss as a result of cash flow hedges for future raw material purchases being canceled following the decision that the occurrence of the hedged transaction had become unlikely.

Effects from derivative financial instruments designated as a hedging relationship

The amounts related to positions designated as hedged items were as follows as of 30 September 2021 and 2020:

€ in millions	Change in the value of the hedged item used to determine ineffectiveness	Hedge reserve (before taxes)
30 September 2021		
Hedging of interest risks		
Interest rate swaps	19	(49)
Hedging of commodity price risks	1	(1)
Total		(50)
30 September 2020		
Hedging of foreign exchange risk		
Deal Contingent Forward	(98)	-
Deal Contingent Option	(75)	-
Hedging of interest risks		
Interest rate swaps	99	(98)
Hedging of commodity price risks	(1)	1
Total		(97)

In the 2021 and 2020 fiscal years, no balances remained in other comprehensive income for which hedge accounting was no longer applied.

The relevant amounts of the derivative financial instruments designated as hedging instruments as of 30 September 2021 and 2020 (before taxes) were as follows:

	Carrying amount	Changes in fair value for the measurement of the ineffectiveness in the reporting period	Changes in fair value of the hedging instrument recognized in other comprehensive income	Changes in fair value of cost of hedging recognized in other comprehensive income	Amount reclassified from hedge reserve to the Statement of Profit or Loss	Amount reclassified from the hedge reserve to the Statement of Profit or Loss from hedging relationships for which the underlying transaction is no longer expected	Amount reclassified from the hedge reserve to the cost of non-financial assets	Amount reclassified from the cost of hedging reserve to the cost of non-financial assets	Line item of the Statement of Financial Position or the Statement of Profit or Loss affected by the reclassification
€ in millions									
30 September 2021									
Other current liabilities:									
Hedging of interest risks	-	(21)	44	-	5	-	-	-	Financial expenses
Hedging of commodity price risks	1	(1)	(1)	-	-	-	(1)	-	Inventories
Total	1	(22)	43	-	5	-	(1)	-	
30 September 2020									
Other current assets:									
Hedging of foreign exchange risks									
Deal Contingent Forward	-	98	(56)	(35)	-	-	70	28	Goodwill
Deal Contingent Option	-	39	(84)	77	-	-	181	(142)	Goodwill
Hedging of commodity price risks	1	1	(2)	-	-	-	(5)	-	Inventories
Other current liabilities:									
Hedging of interest risks	66	(99)	(98)	-	1	(11)	-	-	Financial expenses
Total	67	39	(240)	42	1	(11)	246	(114)	

The following table shows the reconciliation for the reserve for cash flow hedges (before taxes) by risk category:

€ in millions	Hedging of foreign exchange risks	Hedging of interest risks	Hedging of commodity price risks	Total
30 September 2019	98	-	3	101
Change in fair value	39	(99)	3	(57)
Amount reclassified to the Statement of Profit or Loss	-	1	-	1
Amounts reclassified to the cost of non-financial items	(137)	-	(5)	(142)
30 September 2020	-	(98)	1	(97)
Change in fair value	-	44	(1)	43
Amount reclassified to the Statement of Profit or Loss	-	5	-	5
Amounts reclassified to the cost of non-financial items	-	-	(1)	(1)
30 September 2021	-	(49)	(1)	(50)

27 Financial risk management

Infineon's activities are exposed to a variety of financial risks: market risk (including foreign exchange risk, interest rate risk and price risk), credit risk, financing and liquidity risk. Infineon's financial risk management seeks to minimize potential adverse effects on its profitability and liquidity. Infineon uses derivative financial instruments to hedge certain risks to which it is exposed. Financial risk management is carried out by the central Finance & Treasury (FT) department in accordance with policies approved by the Chief Financial Officer. The FT department identifies, evaluates and hedges financial risks in close cooperation with the operating units.

The FT department's policies contain principles for overall risk management as well as guidance covering specific areas such as foreign exchange risk, interest rate risk, credit risk, the use of derivative and non-derivative financial instruments, and the investment of excess liquidity.

The coronavirus pandemic and the related measures to contain the virus can have a direct and indirect effect on financial risks. The course of the spread of the coronavirus and the impact on Infineon's risk position is continually monitored and is taken into account in the methods, models and processes used to control financial risks. Possible longer-term effects on Infineon as a consequence of the spread of the coronavirus and the associated volatility in the financial markets cannot actually be estimated more precisely.

Market risk

Market risk is defined as the risk of losses resulting from adverse changes in the market prices of financial instruments, including those related to foreign exchange rates, interest rates and other price risks.

Infineon is exposed to various market risks in the ordinary course of business, primarily resulting from changes in foreign exchange rates and interest rates. Infineon enters into a range of derivative financial transactions with various counterparties to limit such risks. Derivative instruments are used only for hedging purposes and not for trading or speculative purposes.

Foreign exchange risk

Foreign exchange risk within the meaning of IFRS 7 is the risk arising from changes to foreign exchange rates. Accordingly, foreign exchange risks are associated with financial instruments that are denominated in a foreign currency that does not correspond to the functional currency, and the foreign currency represents the relevant risk variable. Risks arising from the translation into Infineon's reporting currency are not risks within the meaning of IFRS 7.

Although Infineon prepares the Consolidated Financial Statements in euros, a varying but significant portion of its revenue, as well as cost of goods sold, research and development and product distribution costs, are denominated in currencies other than the euro, primarily the US dollar. Fluctuations in the exchange rates of these currencies compared to the euro had an effect on the results of Infineon in the 2021 and 2020 fiscal years.

The Management Board has established policies that require Infineon's individual legal entities to manage the foreign exchange risk with respect to their functional currency. Group entities prepare a monthly rolling cash flow forecast by currency in order to determine foreign exchange risks. The net foreign exchange positions determined in these forecasts are required to be hedged, usually by entering into internal hedging contracts. Infineon's policy with respect to limiting short-term foreign currency exposure is to hedge at least 75 percent of its estimated net cash flow for the following two months, at least 50 percent of its estimated net cash flow for the third month and, depending on the nature of the underlying transactions, a certain additional portion for the periods thereafter. Part of the foreign currency risk cannot be mitigated due to differences between actual and forecasted amounts. Infineon calculates this remaining risk based on net cash flows considering items in the Statement of Financial Position, actual orders received or placed and all other planned cash receipts and payments.

For the net result related to foreign currency hedging transactions and foreign currency transactions included within profit (loss) for the period see note 26. [p. 207](#)

Foreign exchange risk at Infineon arises predominantly from main foreign currency positions. The following table shows the net exposure as of 30 September 2021 and 2020:

€ in millions	30 September 2021	30 September 2020
Euro/US dollar	(138)	34
Euro/Japanese yen	(64)	(86)
Euro/Singapore dollar	(74)	(70)
Euro/Malaysian ringgit	(42)	(48)
Euro/British pound	-	(7)
Financial position exposure	(318)	(177)
Euro/US dollar	(280)	(144)
Euro/Japanese yen	116	37
Euro/Singapore dollar	31	24
Euro/Malaysian ringgit	48	57
Euro/British pound	7	9
Forward exchange contracts	(78)	(17)
Net exposure	(396)	(194)

The following table shows the effects on profit or loss for the 2021 and 2020 fiscal year and equity as of 30 September 2021 and 2020 of a ± 10 percent shift in exchange rates. The assumed exchange rate changes relate only to financial instruments within the meaning of IAS 32.

€ in millions	Profit or Loss		Equity	
	plus 10%	minus 10%	plus 10%	minus 10%
30 September 2021	36	(44)	-	-
Euro/US dollar	38	(46)	-	-
Euro/Japanese yen	(5)	6	-	-
Euro/Singapore dollar	4	(5)	-	-
Euro/Malaysian ringgit	(1)	1	-	-
30 September 2020	18	(22)	6	(7)
Euro/US dollar	10	(12)	6	(7)
Euro/Japanese yen	5	(6)	-	-
Euro/Singapore dollar	4	(5)	-	-
Euro/Malaysian ringgit	(1)	1	-	-

Interest rate risk

In accordance with IFRS 7, interest rate risk is defined as the risk that the fair value or future cash flows of a financial instrument will fluctuate because of changes in interest rates.

Infineon is exposed to interest rate risk through its financial investment instruments and financial debt resulting from bond issuances and debt financing. Due to the cyclical nature of its core business and the need to maintain high operational flexibility, Infineon holds a relatively high level of liquid financial assets that are invested in short-term fixed-interest instruments. These financial assets generally are invested with contract duration of between one and twelve months at interest rates that can be achieved in the short-term. The risk to these assets of changing interest rates is not material in the current period of low or zero interest rates.

To reduce the net remaining risks caused by changes in interest rates, Infineon is able to make use of interest rate derivatives in order to align the fixed interest periods of assets and liabilities.

Interest rate risks related to refinancing measures were partially hedged by interest rate derivatives designated as cash flow hedges in the previous year. These interest rate derivatives matured in the 2021 fiscal year (see note 26, [p. 208 ff.](#)).

IFRS 7 requires a sensitivity analysis showing the effect of possible changes in market interest rates on profit or loss and equity. Infineon prepares this using the iteration method.

Changes in market interest rates affect interest income and expenses from variable-yield financial instruments as well as from fixed-yield financial instruments that are measured at fair value through profit or loss, and also affect equity due to the hedge accounting designated interest rate hedging instruments.

The following table shows the effects on profit or loss for the 2021 and 2020 fiscal year and equity as of 30 September 2021 and 2020 of a ± 100 basis points shift in market interest rates:

€ in millions	Nominal value	Profit or Loss		Equity	
		plus 100 basis points	minus 100 basis points	plus 100 basis points	minus 100 basis points
30 September 2021	1,356	15	(24)	-	-
Variable-interest financial assets	2,458	25	(25)	-	-
Variable-interest financial liabilities	(959)	(10)	1	-	-
Fixed-interest financial liabilities measured at fair value through profit or loss	(143)	-	-	-	-
30 September 2020	353	-	(18)	53	(59)
Variable-interest financial assets	2,220	22	(22)	-	-
Variable-interest financial liabilities	(2,369)	(24)	6	-	-
Fixed-interest financial liabilities measured at fair value through profit or loss	(139)	2	(2)	-	-
Designated interest rate hedging instruments (cash flow hedging relationships)	641	-	-	53	(59)

As in the previous year, Infineon did not hold any fixed-rate financial assets that are measured at fair value through profit or loss. Furthermore, as in the previous year, Infineon did not hold any fixed-interest financial assets that were measured at fair value through other comprehensive income.

Other price risk

According to IFRS 7, other price risk is defined as the risk that the fair value or future cash flows of a financial instrument could fluctuate because of changes in market prices (other than those arising from interest rate risk or exchange rate risk), irrespective of whether those changes are caused by factors specific to the individual financial instrument or its issuer, or by factors affecting all similar financial instruments traded in the market.

In the 2021 fiscal year, Infineon held financial instruments that are exposed to market price risks. A change in the relevant market prices would have had no significant impact on the result of the 2021 and 2020 fiscal years.

Additionally, Infineon is exposed to price risks with respect to raw materials upon which it is dependent. Infineon seeks to minimize these risks through its procurement policy (including the use of multiple sources, where possible) and its operating procedures. In line with these measures, Infineon concluded additional financial derivative contracts for certain commodity supplies (gold) for the following fiscal year in order to mitigate the remaining risk arising from the fluctuation of commodity prices (see note 26, [p. 209 ff.](#)).

The following table presents the effect on equity of a change in the relevant market prices by ± 10 percent as of 30 September 2021 and 2020.

€ in millions	Nominal value	Equity	
		plus 10%	minus 10%
30 September 2021			
Commodity swaps	21	2	(2)
30 September 2020			
Commodity swaps	15	2	(2)

Credit risk

Credit risk arises when a customer or other counterparty of a financial instrument fails to discharge its contractual obligations. Infineon is exposed to this risk as a consequence of its ongoing operations, its financial investments and certain financing activities. Infineon's credit risk arises primarily from cash and cash equivalents, financial investments, trade receivables and derivative financial instruments. Excluding the impact of any collateral received, the carrying amount of financial investments, cash and cash equivalents and trade receivables corresponds to the maximum credit risk.

Foreign exchange and interest hedging contracts as well as the investment of liquid assets in cash equivalents and financial investments are entered into with major financial institutions worldwide that have high credit ratings. Infineon assesses the creditworthiness of banks using a methodology that establishes investment limits for individual banks that are updated on a daily basis based on current ratings (S&P, Moody's or Fitch) and credit default swap premiums. Possible breaches of stipulated investment thresholds result in immediate notification and the requirement to reduce the risk. This methodology is also used to identify a significant increase in credit risk in the context of the recognition of expected credit losses within the meaning of IFRS 9 at the balance sheet date.

Infineon applies the general impairment model in accordance with IFRS 9 for cash and cash equivalents as well as financial investments. Since Infineon invests exclusively in high-quality financial assets from issuers with a rating of at least investment grade in order to minimize default risk, Infineon assumes that its financial assets carry low credit risk arising from the creditworthiness of its contract parties, so that any impairment loss recorded at first-time recognition is limited to the twelve-month expected credit losses. Infineon considers low credit risk to be an internal credit rating "Holding Quality 1". A change in the internal rating from "Holding Quality 1" to "Holding Quality 0" indicates a significant increase in credit risk. The impairment is calculated

using a weighted-probability method. This impairment is calculated as a measure of the probability of default based on the exposure at the balance sheet date, the loss ratio for that exposure, and the credit default swap spread.

The following table provides information on the credit risk for cash and cash equivalents measured at amortized cost, as well as financial investments as of 30 September 2021 and 2020:

Infineon rating	External rating	At amortized cost		
		Basis for the determination of the loss allowance	Expected 12-month credit loss	Expected lifetime credit loss non-credit-impaired
30 September 2021				
Holding Quality 1	AA- to BBB	1,401	1	-
Holding Quality 0	-	-	-	-
Total		1,401	1	-
30 September 2020				
Holding Quality 1	A to BBB	926	1	-
Holding Quality 0	-	-	-	-
Total		926	1	-

As in the previous year, Infineon had no financial assets that were overdue or impaired as of 30 September 2021. There was no reclassification between the impairment levels in the 2021 and 2020 fiscal years.

As in the previous year, Infineon spread its cash investments over more than ten banks as of 30 September 2021. As of 30 September 2021, no financial institution was responsible for more than 18 percent (30 September 2020: 22 percent) of Infineon's cash investments. This gave rise to a maximum risk of €220 million (30 September 2020: €160 million) in the event of the default of a single financial institution assuming no deposit insurance scheme is in place. In addition, to spread the risk of investment, investments were made in money market funds with the best rating, and in money market investment funds. Infineon also held derivative financial instruments with a positive fair value of €2 million as of 30 September 2021 (30 September 2020: €2 million).

Infineon manages the credit risk with respect to trade receivables through a comprehensive credit evaluation for all major customers, the use of credit limits and monitoring procedures. New customers are evaluated for creditworthiness in accordance with Infineon guidelines. Credit limits are also in place for individual customers and creditworthiness and credit limits are constantly monitored. A further measure taken to reduce credit risk is the use of reservation of title clauses. However, despite continuous monitoring, Infineon cannot fully exclude the possibility of a loss arising from the default of one of its contract parties.

Infineon assigns trade receivables to different risk classes based on external ratings, the analysis of customer balance sheet figures, default probabilities (credit default swaps), customer payment behavior and country risks. The simplified method is used to determine the expected losses from trade receivables. The expected losses over the entire term of the trade receivables are determined. The allowance is calculated for each customer using a weighted-probability method. In calculating the expected credit losses, for each customer, Infineon takes into account a forward-looking probability of default provided by a credit rating agency. Individual allowances are recorded based on case-by-case facts or other risk indicators.

The following table provides information about the credit risk for trade receivables from third parties as of 30 September 2021 and 2020:

€ in millions			At amortized cost	
Infineon rating	Risk class	External credit rating	Basis for the determination of the loss allowance	
			30 September 2021	30 September 2020
1	low risk	A- to AAA	406	256
2	average risk	BBB to BBB+	489	470
3	above average risk	BB+ to BBB-	418	296
4	increased risk	BB- to BB	73	109
5	high risk	C to B+	43	48
-	individual	none	4	4
-	others	none	46	9
Total			1,479	1,192

As of 30 September 2021, expected credit losses on trade receivables (see note 9, [p. 178](#)) amounted to €1 million for all risk classes (30 September 2020: €1 million). The individual allowances on trade receivables (no rating) amounted to €4 million in the 2021 fiscal year (2020: €4 million).

Developments in the wake of the coronavirus pandemic are very dynamic, so it cannot be ruled out that the actual credit losses deviate significantly from the expected credit losses recognized based on current estimates and assumptions or that the affected estimates and assumptions will have to be adjusted in future periods and this could have a significant impact on Infineon's expected credit losses.

Financing and liquidity risk

Financing and liquidity risk is the risk that an entity will encounter difficulties in meeting obligations associated with financial liabilities.

Liquidity risk could arise from a potential inability of Infineon to meet maturing financial obligations. Infineon's liquidity management provides that sufficient levels of cash and other liquid assets are available as well as ensuring the availability of funding through adequate levels of committed credit facilities.

The following table discloses the maturity profile for non-derivative financial liabilities and a cash flow analysis for derivative financial instruments with negative fair values. The table shows the undiscounted contractually agreed cash flows that result from the respective financial liability. Cash flows are recognized at the date when Infineon becomes a contractual partner to the financial instrument. Amounts in foreign currencies were translated using the closing rate at the reporting date. The value of financial instruments with variable interest payments is determined using the interest rate from the last interest fixing date before 30 September 2021 and 2020. The cash outflows of financial liabilities that can be repaid at any time are assigned to the period in which the earliest redemption is possible.

€ in millions	Total	Due in the fiscal year					
		2022	2023	2024	2025	2026	Beyond 2026
30 September 2021							
Non-derivative financial liabilities	10,120	3,308	940	1,424	133	1,207	3,108
Derivative financial liabilities:							
Cash outflow	307	307	-	-	-	-	-
Cash inflow ¹	(301)	(301)	-	-	-	-	-
Total	10,126	3,314	940	1,424	133	1,207	3,108
	Total	2021	2022	2023	2024	2025	Beyond 2025
30 September 2020							
Non-derivative financial liabilities	10,054	2,624	1,165	1,846	1,362	92	2,965
Derivative financial liabilities:							
Cash outflow	229	229	-	-	-	-	-
Cash inflow ¹	(161)	(161)	-	-	-	-	-
Total	10,122	2,692	1,165	1,846	1,362	92	2,965

¹ Cash inflows from derivative financial liabilities that arise upon settlement of the instrument.

Future cash flows from derivative financial instruments (see note 26, [p. 207 ff.](#)) may differ from the amounts shown in the table, since exchange rates or relevant factors are subject to change.

28 Segment reporting

Identification of segments

The basis for identifying the reporting segments is the differences between the products and applications. In the 2021 fiscal year, Infineon's business was structured into the four operating segments Automotive, Industrial Power Control, Power & Sensor Systems and Connected Secure Systems. In addition, Infineon differentiates Other Operating Segments as well as Corporate and Eliminations.

Automotive

The Automotive segment designs, develops, manufactures and markets semiconductor products used in the automotive industry (powertrain, driver assistance and safety systems, information security, infotainment and comfort electronics), and also memory products for specific applications.

Industrial Power Control

The Industrial Power Control segment designs, develops, manufactures and markets semiconductor products for the conversion of electrical energy for small, medium and high-power applications. The products are used in the manufacturing, the low-loss transmission, the storage and the efficient use of electrical energy.

Power & Sensor Systems

The Power & Sensor Systems segment designs, develops, manufactures and markets semiconductors for energy-efficient power supplies, mobile devices, mobile phone network infrastructures, human-machine interaction as well as applications with special demands on their robustness and reliability.

Connected Secure Systems

The Connected Secure Systems segment designs, develops, manufactures and markets semiconductor-based security solutions for networked devices, card-based applications, and government documents, on the one hand, and microcontrollers for industrial, entertainment, and household applications, components for connectivity solutions; and a customer support ecosystem consisting of software, services, and development platforms, on the other.

Other Operating Segments

Other Operating Segments comprise the remaining activities of divested businesses and other business activities. Since the sale of the Wireless mobile phone business, supplies to Intel Mobile Communications and MaxLinear are included in this segment. Also included are supplies of LDMOS wafers and related components to Wolfspeed, Inc. (formerly Cree, Inc.), since the sale of the major part of Infineon's Radio Frequency Power Components business.

Corporate and Eliminations

Corporate and Eliminations reflects the elimination of intragroup revenue and profits/losses to the extent that these arise between the segments.

Similarly, certain items are included in Corporate and Eliminations, which are not allocated to the other segments. These include certain corporate headquarters costs and selected topics, which are not allocated to the segments since they arise from corporate decisions and are not within the direct control of segment management.

Furthermore, raw materials and supplies are mostly not under the control or responsibility of the operating segment management and are therefore allocated to corporate functions. Work in progress and finished goods are allocated to the operating segments.

Chief Operating Decision Maker, definition of Segment Result and allocation of assets and liabilities to the individual segments

The Management Board, as joint Chief Operating Decision Maker, decides how resources are allocated to the segments.

Based on revenue and Segment Result, the Management Board assesses performance and defines operating targets and budgets for the segments.

Segment Result is defined as operating profit excluding certain net impairments and reversal of impairments (in particular on goodwill), the impact on earnings of restructuring and closures, share-based payment, acquisition-related depreciation/amortization and other expense, impact on earnings of sales of businesses or interests in subsidiaries, and other income (expense).

Decisions relating to financing and the investment of cash funds are taken at a Group level and not at a segment level. For this reason, financial income and financial expense (including interest income and expense) are not allocated to the segments.

Neither assets, liabilities nor cash flows per segment are reported to the Management Board on a regular basis, nor is segment performance assessed on this basis.

The exception to this approach is certain inventory information which is regularly analyzed at a segment level. Infineon also allocates depreciation and amortization expense to the operating segments based on production volume and products produced using standard costs.

Segment information

The XMC™ family of industrial microcontrollers business was transferred from the Automotive segment to the Connected Secure Systems segment with effect from 1 October 2020. The previous year's figures have been adjusted accordingly.

€ in millions	Product category									
	Total		Power semiconductors		Embedded Control & Connectivity		RF & sensors		Memory ICs for specific applications	
	2021	2020	2021	2020	2021	2020	2021	2020	2021	2020
Revenue from contracts with customers:										
Automotive	4,841	3,521	2,364	1,864	1,228	855	648	551	601	251
Industrial Power Control	1,542	1,406	1,542	1,406	-	-	-	-	-	-
Power & Sensor Systems	3,268	2,650	2,299	1,921	265	99	704	630	-	-
Connected Secure Systems	1,397	974	-	-	1,397	974	-	-	-	-
Subtotal	11,048	8,551	6,205	5,191	2,890	1,928	1,352	1,181	601	251
Other Operating Segments	12	16								
Corporate and Eliminations	-	-								
Total	11,060	8,567								

There were limited levels of trading relationships between the operating segments during the 2021 and 2020 fiscal years. Costs are generally recharged without impact on profit or loss.

€ in millions	2021	2020
Segment Result:		
Automotive	792	147
Industrial Power Control	275	256
Power & Sensor Systems	823	636
Connected Secure Systems	182	130
Other Operating Segments	2	3
Corporate and Eliminations	(2)	(2)
Total	2,072	1,170

The following table provides the reconciliation of Segment Result to profit (loss) from continuing operations before income taxes:

€ in millions	2021	2020
Segment Result:	2,072	1,170
Plus/minus:		
Reversal of impairments (impairments) (in particular on goodwill)	1	11
Impact on earnings of restructuring and closures, net	-	(20)
Share-based payment	(27)	(14)
Acquisition-related depreciation/amortization and other expenses	(544)	(540)
Gains (losses) on sales of businesses, or interests in subsidiaries, net	(1)	1
Other income and expense, net	(31)	(27)
Operating profit	1,470	581
Financial income	22	29
Financial expenses	(182)	(177)
Share of profit (loss) of associates and joint ventures accounted for using the equity method	9	(9)
Profit (loss) from continuing operations before income taxes	1,319	424

Of the €544 million (2020: €540 million) “Acquisition-related depreciation/amortization and other expenses” incurred in the 2021 fiscal year, €295 million (2020: €316 million) was attributable to cost of goods sold, €15 million (2020: €18 million) to research and development expenses, €220 million (2020: €161 million) to selling, general and administrative expenses and €14 million (2020: €45 million) to other operating income and expense.

€ in millions	2021	2020
Depreciation and amortization:		
Automotive	509	495
Industrial Power Control	186	181
Power & Sensor Systems	272	226
Connected Secure Systems	70	62
Other Operating Segments	3	3
Depreciation and amortization allocated to the segments	1,040	967
Depreciation and amortization not allocated to the segments	473	293
Total depreciation and amortization	1,513	1,260

€ in millions	30 September 2021	30 September 2020
Inventories:		
Automotive	990	975
Industrial Power Control	232	251
Power & Sensor Systems	565	449
Connected Secure Systems	149	190
Other Operating Segments	2	3
Corporate and Eliminations	243	184
Total	2,181	2,052

Impairment losses on assets in the 2021 fiscal year amounted to €0 million (2020: €5 million) in the Automotive segment, €18 million (2020: €5 million) in the Power & Sensor Systems segment, and €9 million (2020: €13 million) in Corporate and Eliminations. Also allocated to Corporate and Eliminations in the 2021 fiscal year was €15 million (2020: €11 million) of reversal of impairments to assets.

Entity-wide disclosures in accordance with IFRS 8

Revenue for the 2021 and 2020 fiscal years by region was as follows:

€ in millions	2021	2020
Revenue:		
Europe, Middle East, Africa	2,773	2,322
therein: Germany	1,278	1,056
Asia-Pacific (excluding Japan, Greater China)	1,744	1,291
Greater China ¹	4,195	3,174
therein: Mainland China, Hong Kong	3,178	2,472
Japan	1,094	765
Americas	1,254	1,015
therein: USA	1,027	845
Total	11,060	8,567

¹ Greater China comprises Mainland China, Hong Kong and Taiwan.

The allocation of revenues from external customers to geographic areas is based on the customers' locations. The average number of employees by geographic region is provided in note 3. [p. 171](#)

No single customer accounted for more than 10 percent of Infineon's revenue during the 2021 and 2020 fiscal year.

Non-current assets as of 30 September 2021 and 2020, by region, were as follows:

€ in millions	30 September 2021	30 September 2020
Non-current assets:		
Europe	4,107	3,627
therein: Germany	2,582	2,495
Asia-Pacific (excluding Japan, Greater China)	1,167	1,182
Greater China ¹	106	73
therein: Mainland China, Hong Kong	92	67
Japan	18	14
Americas	8,790	9,137
therein: USA	8,778	9,124
Total	14,188	14,033

¹ Greater China comprises Mainland China, Hong Kong and Taiwan.

Non-current assets do not include financial instruments, deferred tax assets and assets from employee benefits.

29 Additional information in accordance with HGB

Information pursuant to section 161 Stock Corporation Act (AktG)

The Declaration of Compliance prescribed by section 161 AktG was drawn up by the Management Board and the Supervisory Board and made permanently available to the public on Infineon's website.

www.infineon.com/cms/en/about-infineon/investor/corporate-governance/#corporate-governance

Fees for audit and advisory services pursuant to section 314, paragraph 1, no. 9 HGB

Year-end audit fees

At the Annual General Meeting held on 25 February 2021, the shareholders elected KPMG AG Wirtschaftsprüfungsgesellschaft ("KPMG"), Munich, as auditor for the 2021 Separate Financial Statements and the Consolidated Financial Statements of Infineon Technologies AG. The audit fees charged by KPMG in the 2021 fiscal year amounted to €3.7 million for the audit of the Consolidated Financial Statements and various annual audits, including an audit review of the Interim Financial Statements.

Fees for other advisory services

In addition to the amounts described above, KPMG charged an aggregate of €0.3 million in the 2021 fiscal year for other audit services which mainly included the provision of a comfort letter as well as the audit of the disclosures in the Sustainability Report.

Fees for tax advisory services

In addition to the amounts described above, KPMG charged €29 thousand in the 2021 fiscal year for tax consulting services in connection with the assessment of individual items.

Fees for other services

Fees of €0.1 million were charged by KPMG to the Company in the 2021 fiscal year for other services. These mainly included quality assurance during the implementation of regulatory requirements.

Management Board and Supervisory Board

Management remuneration in the 2021 fiscal year

As required by section 314, paragraph 1, no. 6a, sentences 5 to 8, HGB (version before ARUG II), the remuneration of the individual members of the Management Board and the Supervisory Board is disclosed in the remuneration report, [p. 132 ff.](#), which is part of the Combined Management Report.

Management Board

The Management Board members during the 2021 fiscal year were as follows:

Name	Position	Membership of Supervisory Boards and other comparable governing bodies of domestic and foreign companies (as of 30 September 2021)
Dr. Reinhard Ploss	Chief Executive Officer, Labor Director	Supervisory Board member <ul style="list-style-type: none"> › Infineon Technologies Austria AG, Austria (Chairman) › Futurium gGmbH, Germany Member of the Board of Directors <ul style="list-style-type: none"> › Infineon Technologies Americas Corp., USA
Dr. Sven Schneider	Chief Financial Officer	Supervisory Board member <ul style="list-style-type: none"> › Infineon Technologies Austria AG, Austria Member of the Board of Directors <ul style="list-style-type: none"> › Infineon Technologies China K.K., Ltd., People's Republic of China › Infineon Technologies Asia Pacific Pte., Ltd., Singapore › Infineon Technologies Americas Corp., USA
Dr. Helmut Gassel	Chief Marketing Officer	Member of the Board of Directors <ul style="list-style-type: none"> › Infineon Technologies Asia Pacific Pte., Ltd., Singapore (Chairman) › Infineon Technologies Japan K.K., Japan (Chairman) › Infineon Technologies China Co., Ltd., People's Republic of China › Infineon Technologies Americas Corp., USA (Chairman)
Jochen Hanebeck	Chief Operations Officer	Supervisory Board member <ul style="list-style-type: none"> › Infineon Technologies Austria AG, Austria
Constanze Hufenbecher	Chief Digital Transformation Officer	Supervisory Board member <ul style="list-style-type: none"> › Voith GmbH & Co. KGaA, Germany Member of the Shareholders' Committee <ul style="list-style-type: none"> › Voith Management GmbH, Germany

The Supervisory Board

The Supervisory Board members during the 2021 fiscal year, the Supervisory Board position held by them, their occupation, and their membership of other supervisory and governing bodies are as follows:

Name	Position	Membership of other Supervisory Boards and other comparable governing bodies of domestic and foreign companies (as of 30 September 2021)
Dr. Wolfgang Eder Chairman	Member of various supervisory bodies	Supervisory Board member › voestalpine AG, Austria
Johann Dechant ¹ Deputy Chairman	Vice-Chairman of the Joint Works Council and Chairman of the Works Council Regensburg, Infineon Technologies AG	Member of the Administrative Board › SBK Siemens-Betriebskrankenkasse, Germany
Xiaoqun Clever	Management Consultant – LuxNova Suisse GmbH	Supervisory Board member › Capgemini SE, France › Amadeus IT Group SA, Spain Member of the Administrative Board › Cornelsen Group, Germany Member of the Board of Directors › BHP Group Plc., UK and BHP Group Ltd., Australia
Dr. Friedrich Eichiner	Member of various supervisory bodies	Supervisory Board member › Festo Management SE, Germany (Chairman) › Allianz SE, Germany
Annette Engelfried ¹	Labor union secretary IG Metall district management, Berlin-Brandenburg-Saxony	Supervisory Board member › Infineon Technologies Dresden Verwaltungs GmbH, Germany › Siemens Gamesa Renewable Energy Management GmbH, Germany
Peter Gruber ¹ Representative of Senior Management	Chief Financial Officer Operations, Infineon Technologies AG	Supervisory Board member › Infineon Technologies Dresden Verwaltungs GmbH, Germany
Hans-Ulrich Holdenried	Independent Management Consultant	Member of the Advisory Board › Bridge imp GmbH, Germany
Dr. Susanne Lachenmann ¹	Principal Engineer	

Name	Position	Membership of other Supervisory Boards and other comparable governing bodies of domestic and foreign companies (as of 30 September 2021)
Géraldine Picaud	Chief Financial Officer, Holcim Ltd., Switzerland	Member of the Board of Directors › Holcim Group Services Ltd, Switzerland › Holcim Technology Ltd, Switzerland › Lafarge Maroc SA, Morocco › LafargeHolcim Maroc SAS, Morocco › LafargeHolcim Maroc Afrique SAS, Morocco › Huaxin Cement Co., Ltd., People's Republic of China
Dr. Manfred Puffer	Independent Management Consultant	Supervisory Board member › Athora Lebensversicherung AG, Germany › Nova KBM Bank, Slovenia › Servicios Prescriptor y Medios de Pagos, S.A.U., Spain › Oldenburgische Landesbank AG, Germany Member of the Board of Directors › Athene Holding Ltd., Bermuda › Catalina Holdings (Bermuda) Ltd., Bermuda
Melanie Riedl ¹	Analysis Engineer and Vice Chairwoman of the Works Council Campeon, exempted member of the Works Council	
Jürgen Scholz ¹	First authorized agent of IG Metall Regensburg	Supervisory Board member › Kronos AG, Germany Member of the Administrative Board › BKK of BMW AG, Germany
Kerstin Schulzendorf ¹	Expert in the frontend-manufacturing, Infineon Technologies Dresden GmbH & Co. KG	
Dr. Ulrich Spiesshofer	Senior advisor – The Blackstone Group, member of various advisory boards and investor	
Margret Suckale	Member of various supervisory bodies	Supervisory Board member › HeidelbergCement AG, Germany › Deutsche Telekom AG, Germany › DWS Group GmbH & Co. KGaA, Germany
Diana Vitale ¹	Deputy Chairwoman of the Infineon Works Council, Warstein, Infineon Technologies AG	

¹ Employee representative

Supervisory Board committees

Mediation Committee

Dr. Wolfgang Eder (Chairman)

Johann Dechant

Hans-Ulrich Holdenried

Jürgen Scholz

Executive Committee

Dr. Wolfgang Eder (Chairman)

Johann Dechant

Annette Engelfried

Hans-Ulrich Holdenried

Margret Suckale

Diana Vitale

Investment, Finance and Audit Committee

Dr. Friedrich Eichiner (Chairman)

Johann Dechant

Dr. Wolfgang Eder

Annette Engelfried

Strategy and Technology Committee

Dr. Ulrich Spiesshofer (Chairman)

Xiaoqun Clever

Dr. Wolfgang Eder

Peter Gruber

Dr. Susanne Lachenmann

Jürgen Scholz

Nomination Committee

Dr. Wolfgang Eder (Chairman)

Dr. Manfred Puffer

Margret Suckale

The business address of each member of the Supervisory Board is:
Infineon Technologies AG, Am Campeon 1–15, D-85579 Neubiberg (Germany).

Subsidiaries, associated companies, joint ventures and other companies (not consolidated) as of 30 September 2021

GRI 102-45

Name of company	Registered office	Shareholdings in %	thereof Infineon Technologies AG	Equity (€ in millions)	Net result (€ in millions)	Footnote
Fully consolidated subsidiaries:						
5200 Ben White Condominiums Association, Inc.	Austin, Texas, USA	n.a.	0	0.00	0.00	11, 26, 30
AgigA Tech, Inc.	Wilmington, Delaware, USA	100	0	(2.28)	(2.23)	11, 30
Cirrent, LLC	Wilmington, Delaware, USA	100	0	0.00	0.00	11, 30
CYLand Corp.	General Trias, Philippines	40	0	1.42	(0.04)	6, 27
Cypress Innovates G.K.	Kawasaki, Japan	100	0	20.96	1.33	10
Cypress International, LLC	Wilmington, Delaware, USA	100	0	0.00	0.00	11, 30
Cypress Manufacturing, Ltd.	Camana Bay (George Town), Cayman Islands	100	0	71.27	0.72	11, 30
Cypress Semiconductor (Canada), Inc.	Kanata, Ontario, Canada	100	0	0.04	0.03	8
Cypress Semiconductor (Malaysia) Sdn. Bhd.	Melaka, Malaysia	100	0	6.96	0.58	17
Cypress Semiconductor (Mauritius) LLC	Ebène, Mauritius	100	0	0.18	(0.02)	7
Cypress Semiconductor (Scandinavia) AB	Stockholm, Sweden	100	0	0.62	(0.09)	17
Cypress Semiconductor (Switzerland) Sàrl	Lausanne, Switzerland	100	0	17.84	(0.33)	17
Cypress Semiconductor (Thailand) Limited	Nonhaburi, Thailand	100	0	78.26	1.98	17
Cypress Semiconductor (UK) Limited	Bristol, Great Britain	100	0	5.33	(0.25)	5
Cypress Semiconductor Corporation	Wilmington, Delaware, USA	100	0	5,693.76	(471.58)	11, 30
Cypress Semiconductor GmbH	Munich, Germany	100	0	8.64	1.36	6
Cypress Semiconductor Hong Kong Private Limited	Hong Kong, People's Republic of China	100	0	0.40	0.05	4
Cypress Semiconductor International Sales B.V.	Amsterdam, The Netherlands	100	0	6.07	0.01	17
Cypress Semiconductor International, Inc.	Wilmington, Delaware, USA	100	0	299.78	(0.36)	11, 30
Cypress Semiconductor Ireland Limited	Cork, Ireland	100	0	4.24	0.78	6
Cypress Semiconductor Italia S.r.l.	Basiglio (Milan), Italy	100	0	0.31	(0.03)	6
Cypress Semiconductor Korea Ltd.	Seoul, Republic of Korea	100	0	2.86	0.64	17
Cypress Semiconductor México, S. de R.L. de C.V.	Guadalajara, Mexico	100	0	(0.04)	(0.01)	17
Cypress Semiconductor Philippines Headquarters, Ltd.	Camana Bay (George Town), Cayman Islands	100	0	5.78	0.02	11, 30
Cypress Semiconductor Singapore Pte. Ltd.	Singapore, Singapore	100	0	6.27	0.53	17
Cypress Semiconductor Technology (Shanghai) Co. Ltd.	Shanghai, People's Republic of China	100	0	4.90	0.73	17
Cypress Semiconductor Technology India Private Limited	Bangalore, India	100	0	31.49	4.38	7
Cypress Semiconductor Technology Ltd.	Camana Bay (George Town), Cayman Islands	100	0	253.17	(0.82)	11, 30

Name of company	Registered office	Shareholdings in %	thereof Infineon Technologies AG	Equity (€ in millions)	Net result (€ in millions)	Footnote
Cypress Semiconductor Ukraine LLC	Lviv, Ukraine	100	0	2.02	0.11	17
Cypress Semiconductor World Trade Corp.	Camana Bay (George Town), Cayman Islands	100	0	6.08	0.00	11, 30
Hitex GmbH	Karlsruhe, Germany	100	100	2.16	0.00	3, 20, 22
Infineon Integrated Circuit (Beijing) Co., Ltd.	Beijing, People's Republic of China	100	0	15.27	1.14	17
Infineon Semiconductors (Shenzhen) Co., Ltd.	Shenzhen, People's Republic of China	100	0	1.39	0.03	18
Infineon Semiconductors (Wuxi) Co., Ltd.	Wuxi, People's Republic of China	100	0	45.53	1.74	17
Infineon Technologies (Advanced Logic) Sdn. Bhd.	Melaka, Malaysia	100	0	27.79	2.33	9
Infineon Technologies (Kulim) Sdn. Bhd.	Kulim, Malaysia	100	0	326.53	1.21	9
Infineon Technologies (Malaysia) Sdn. Bhd.	Melaka, Malaysia	100	0	355.15	36.46	9
Infineon Technologies (Wuxi) Co., Ltd.	Wuxi, People's Republic of China	100	0	123.92	10.55	17
Infineon Technologies (Xi'an) Co., Ltd.	Xi'an, People's Republic of China	100	0	8.31	0.37	17
Infineon Technologies 2. Vermögensverwaltungsgesellschaft mbH	Neubiberg, Germany	100	0	0.01	(0.02)	9
Infineon Technologies Americas Corp.	Wilmington, Delaware, USA	100	0	2,563.29	248.35	9, 30
Infineon Technologies Asia Pacific Pte Ltd	Singapore, Singapore	100	0	639.88	128.42	9
Infineon Technologies Australia Pty Limited	Blackburn, Australia	100	0	1.40	0.08	9
Infineon Technologies Austria AG	Villach, Austria	100	0.004	1,186.02	163.15	9
Infineon Technologies Cegléd Kft.	Cegléd, Hungary	100	0	24.82	(0.70)	9
Infineon Technologies Center of Competence (Shanghai) Co., Ltd.	Shanghai, People's Republic of China	100	0	3.03	0.09	17
Infineon Technologies China Co., Ltd.	Shanghai, People's Republic of China	100	0	187.05	17.39	17
Infineon Technologies Denmark ApS	Herlev, Denmark	100	0	4.72	0.22	9
Infineon Technologies Dresden GmbH & Co. KG	Dresden, Germany	100	100	246.52	8.70	9, 23
Infineon Technologies Dresden Verwaltungs GmbH	Neubiberg, Germany	100	0	0.09	0.00	9, 20, 21
Infineon Technologies Epi Services, Inc.	Wilmington, Delaware, USA	100	0	8.16	3.25	9, 30
Infineon Technologies Finance B.V.	Rotterdam, The Netherlands	100	100	1.97	(0.03)	12
Infineon Technologies France S.A.S.	St. Denis, France	100	0	9.10	0.64	9
Infineon Technologies Holding Asia Pacific Pte. Ltd.	Singapore, Singapore	100	0	2,916.15	7.61	9
Infineon Technologies Holding B.V.	Rotterdam, The Netherlands	100	100	10,814.67	54.71	9
Infineon Technologies Hong Kong Ltd.	Hong Kong, People's Republic of China	100	0	2.03	0.40	9
Infineon Technologies India Private Limited	Bangalore, India	100	0	14.33	2.65	7
Infineon Technologies Investment B.V.	Rotterdam, The Netherlands	100	0	0.11	0.00	9
Infineon Technologies Ireland Limited	Dublin, Ireland	100	100	0.41	0.14	9
Infineon Technologies Italia s.r.l.	Milan, Italy	100	0	7.25	2.18	9
Infineon Technologies IT-Services GmbH	Klagenfurt, Austria	100	0	10.24	5.61	9

Name of company	Registered office	Shareholdings in %	thereof Infineon Technologies AG	Equity (€ in millions)	Net result (€ in millions)	Footnote
Infineon Technologies Japan K.K.	Tokyo, Japan	100	0	40.64	6.17	9
Infineon Technologies Korea Co., LLC	Seoul, Republic of Korea	100	0	13.42	3.92	9
Infineon Technologies Linz GmbH & Co KG	Linz, Austria	100	0	5.94	5.89	9
Infineon Technologies LLC	Wilmington, Delaware, USA	100	0	121.66	49.30	11, 30
Infineon Technologies Maasstad C.V.	Rotterdam, The Netherlands	100	0	26.80	2.08	9
Infineon Technologies Memory Solutions Germany GmbH	Neubiberg, Germany	100	0	0.02	0.00	9
Infineon Technologies Memory Solutions Holdings Inc.	Wilmington, Delaware, USA	100	0	68.48	0.00	15, 30
Infineon Technologies Memory Solutions India LLP	Bangalore, India	100	0	n.a.	n.a.	19
Infineon Technologies Memory Solutions Israel Ltd.	Netanya, Israel	100	0	62.14	2.83	4
Infineon Technologies Memory Solutions Japan G.K.	Kawasaki, Japan	100	0	0.04	0.00	14, 30
Infineon Technologies Memory Solutions Malaysia Sdn. Bhd.	Kuala Lumpur, Malaysia	100	0	0.00	0.00	13, 30
Infineon Technologies Memory Solutions Taiwan Ltd.	Taipei, Taiwan	100	0	n.a.	n.a.	19
Infineon Technologies Nordic AB	Kista, Sweden	100	0	5.14	0.23	9
Infineon Technologies Philippines, Inc.	Muntinlupa City, Philippines	100	0	0.20	0.26	9
Infineon Technologies Power Semitech Co., Ltd.	Cheonan, Republic of Korea	100	100	55.82	2.77	9
Infineon Technologies Reigate Limited	Bristol, Great Britain	100	0	17.00	0.81	9
Infineon Technologies Romania & Co. Societate in Comandita	Bucharest, Romania	100	0	4.58	1.70	9
Infineon Technologies Shared Service Center, Unipessoal Lda.	Maia, Portugal	100	100	3.50	0.62	3
Infineon Technologies Taiwan Co., Ltd.	Taipei, Taiwan	100	0	8.60	1.55	9
Infineon Technologies UK Limited	Bristol, Great Britain	100	0	1.51	1.92	9
Infineon Technologies US HoldCo Inc.	Wilmington, Delaware, USA	100	0	2,231.98	277.82	9, 30
Infineon Technologies US InterCo LLC	Wilmington, Delaware, USA	100	0	1,532.80	271.26	9, 30
Infineon Technologies US Investment LLC	Wilmington, Delaware, USA	100	0	(0.04)	19.25	9, 30
Infineon Technologies Vermögensverwaltungsgesellschaft mbH	Neubiberg, Germany	100	100	125.22	0.00	9, 20, 21
International Rectifier HiRel Denmark ApS	Herlev, Denmark	100	0	1.06	0.26	9
International Rectifier HiRel Products, Inc.	Wilmington, Delaware, USA	100	0	147.82	28.45	9, 30
International Rectifier Mauritius, Inc. (in liquidation)	Curepipe, Mauritius	100	0	0.00	0.00	9, 30
MOLSTANDA Vermietungsgesellschaft mbH	Neubiberg, Germany	100	6	133.40	0.00	9, 20, 21
MOTEON GmbH	Neubiberg, Germany	100	100	0.03	0.00	9
MoTo Objekt CAMPEON GmbH & Co. KG	Neubiberg, Germany	93	0	107.28	23.81	9, 24
Nihon Cypress G.K.	Kawasaki, Japan	100	0	6.37	6.33	10
PT Infineon Technologies Batam	Batam, Indonesia	100	0	17.08	1.22	9
Ramtron International Corporation	Wilmington, Delaware, USA	100	0	0.00	0.00	11, 30

Name of company	Registered office	Shareholdings in %	thereof Infineon Technologies AG	Equity (€ in millions)	Net result (€ in millions)	Footnote
Rectificadores Internacionales, S.A. de C.V.	Tijuana, Mexico	100	0	7.31	1.14	9, 30
SILTECTRA GmbH	Dresden, Germany	100	0	3.19	0.25	9
Spansion Inc.	Wilmington, Delaware, USA	100	0	516.15	(0.03)	11, 30
Spansion LLC	Wilmington, Delaware, USA	100	0	678.49	162.27	11, 30
Associated companies:						
Deca Technologies, Inc.	Dover, Delaware, USA	42.5	0	8.93	(16.05)	17, 30
pmdtechnologies ag	Siegen, Germany	15	15	30.12	(10.59)	17, 28
SkyHigh Memory Limited	Hong Kong, People's Republic of China	40	0	13.67	4.71	17
Joint ventures:						
Infineon Technologies Bipolar GmbH & Co. KG	Warstein, Germany	60	60	38.65	(3.75)	9, 29
SAIC Infineon Automotive Power Modules (Shanghai) Co., Ltd	Shanghai, People's Republic of China	49	25	(10.73)	(10.32)	17
Other companies (not consolidated):¹						
CHiL Semiconductors Corporation	Wilmington, Delaware, USA	100	0	0.00	0.00	9
EPOS embedded core & power systems GmbH & Co. KG	Duisburg, Germany	100	100	1.04	0.35	9
EPOS embedded core & power systems Verwaltungs GmbH	Duisburg, Germany	100	100	0.07	0.00	9
Futurium gGmbH	Berlin, Germany	n.a.	n.a.	n.a.	n.a.	25
Hitex (UK) Limited	Coventry, Great Britain	100	0	2.13	0.09	9
Infineon Technologies Bipolar Verwaltungs GmbH	Warstein, Germany	60	60	0.03	0.00	9
Infineon Technologies Campeon Verwaltungsgesellschaft mbH	Neubiberg, Germany	100	0	0.11	0.02	9
Infineon Technologies Delta GmbH	Neubiberg, Germany	100	100	0.01	0.00	9
Infineon Technologies Gamma GmbH	Neubiberg, Germany	100	100	0.01	0.00	9
Infineon Technologies Holding GmbH	Neubiberg, Germany	100	100	0.13	0.00	9, 20
Infineon Technologies Iberia, S.L.U.	Madrid, Spain	100	0	0.15	0.04	9
Infineon Technologies Linz Verwaltungs GmbH	Linz, Austria	100	0	0.12	0.00	9
Infineon Technologies Mantel 26 AG	Neubiberg, Germany	100	100	0.03	0.00	9
Infineon Technologies Mantel 27 GmbH	Neubiberg, Germany	100	100	0.03	0.00	9, 20
Infineon Technologies Mantel 29 GmbH	Neubiberg, Germany	100	100	0.03	0.00	9, 20
Infineon Technologies Polska Sp. z o.o.	Warsaw, Poland	100	0	0.11	0.02	9
Infineon Technologies Romania s.r.l.	Bucharest, Romania	100	0	0.04	0.01	17
Infineon Technologies RUS LLC	Moscow, Russian Federation	100	0	0.22	0.02	17

Name of company	Registered office	Shareholdings in %	thereof Infineon Technologies AG	Equity (€ in millions)	Net result (€ in millions)	Footnote
Infineon Technologies South America Ltda	São Paulo, Brasil	100	0	0.07	0.00	17
Infineon Technologies Vietnam Company Ltd.	Hanoi, Vietnam	100	0	0.09	0.03	9
IR International Holdings China, Inc.	Wilmington, Delaware, USA	100	0	0.00	0.00	9
KAI Kompetenzzentrum Automobil- und Industrieelektronik GmbH	Villach, Austria	100	0	0.57	0.29	17
KFE Kompetenzzentrum Fahrzeug Elektronik GmbH	Lippstadt, Germany	24	24	1.40	0.07	17
Metawave Corporation	Dover, Delaware, USA	n.a.	0	n.a.	n.a.	25
MicroLinks Technology Corp.	Kaohsiung, Taiwan	n.a.	0	n.a.	n.a.	25
OSPT IP Pool GmbH	Neubiberg, Germany	100	100	0.01	0.00	9
PT Infineon Technologies Indonesia	Jakarta, Indonesia	100	0	0.00	0.00	16
R Labco, Inc.	Wilmington, Delaware, USA	100	0	0.00	0.00	9
Rapt Touch Ireland Ltd.	Dublin, Ireland	n.a.	0	n.a.	n.a.	25
Schweizer Electronic AG	Schramberg, Germany	9	9	46.28	(9.15)	17
Silicon Alps Cluster GmbH	Villach, Austria	n.a.	0	n.a.	n.a.	25
TTTech Auto AG	Vienna, Austria	n.a.	n.a.	n.a.	n.a.	25
Virtual Vehicle Research GmbH	Graz, Austria	n.a.	n.a.	n.a.	n.a.	25
XMOS Limited	Bristol, Great Britain	n.a.	0	n.a.	n.a.	25
Qimonda AG and its subsidiaries:²						
Celis Semiconductor Corp.	Colorado Springs, Colorado, USA	17		–	–	2
Itarion Solar Lda.	Vila do Conde, Portugal	40		–	–	2
Qimonda (Malaysia) Sdn. Bhd. (in liquidation)	Melaka, Malaysia	77		–	–	2
Qimonda AG (in insolvency)	Munich, Germany	77	28	–	–	2
Qimonda Asia Pacific Pte. Ltd.	Singapore, Singapore	77		–	–	2
Qimonda Belgium BVBA (in insolvency)	Leuven, Belgium	77		–	–	2
Qimonda Bratislava s.r.o. (in liquidation)	Bratislava, Slovakia	77		–	–	2
Qimonda Dresden GmbH & Co. OHG (in insolvency)	Dresden, Germany	77		–	–	2
Qimonda Dresden Verwaltungsgesellschaft mbH (in insolvency)	Dresden, Germany	77		–	–	2
Qimonda Finance LLC (in insolvency)	Wilmington, Delaware, USA	77		–	–	2
Qimonda Flash GmbH (in insolvency)	Dresden, Germany	77		–	–	2
Qimonda France SAS (in liquidation)	St. Denis, France	77		–	–	2
Qimonda Holding B.V. (in insolvency)	Rotterdam, The Netherlands	77		–	–	2
Qimonda International Trade (Shanghai) Co. Ltd.	Shanghai, People's Republic of China	77		–	–	2
Qimonda Investment B.V.	Rotterdam, The Netherlands	77		–	–	2

Name of company	Registered office	Shareholdings in %	thereof Infineon Technologies AG	Equity (€ in millions)	Net result (€ in millions)	Footnote
Qimonda IT (Suzhou) Co., Ltd. (in liquidation)	Suzhou, People's Republic of China	77		–	–	2
Qimonda Italy s.r.l. (in liquidation)	Padua, Italy	77		–	–	2
Qimonda Korea Co. Ltd. (in liquidation)	Seoul, Republic of Korea	77		–	–	2
Qimonda Licensing LLC	Fort Lauderdale, Florida, USA	77		–	–	2
Qimonda Memory Product Development Center (Suzhou) Co. (in liquidation)	Suzhou, People's Republic of China	77		–	–	2
Qimonda North America Corp. (in insolvency)	Wilmington, Delaware, USA	77		–	–	2
Qimonda Richmond LLC (in insolvency)	Wilmington, Delaware, USA	77		–	–	2
Qimonda Taiwan Co. Ltd. (in liquidation)	Taipei, Taiwan	77		–	–	2
Qimonda UK Ltd. (in liquidation)	High Blantyre, Scotland	77		–	–	2

1 Certain subsidiaries were not consolidated due to immateriality.

2 On 23 January 2009, Qimonda AG applied to the Munich District Court for insolvency proceedings to be opened. Insolvency proceedings were formally opened on 1 April 2009. The equity and earnings of Qimonda AG and its subsidiaries are not disclosed due to the substantial and ongoing restriction of Infineon's rights as a result of Qimonda AG's insolvency. The list of subsidiaries held by Qimonda AG is based on information from 30 September 2010, since Infineon had not received any further information from the insolvency administrator of Qimonda AG with respect to the insolvency or liquidation of Qimonda companies, and further reflects information from the German commercial register. Since all Qimonda-related investments were written down in full in previous years, this has no effect on Infineon's net assets, financial position and results of operations.

3 Equity and net result as of 30 September 2019.

4 Equity and net result as of 29 December 2019.

5 Equity and net result as of 30 December 2019.

6 Equity and net result as of 31 December 2019.

7 Equity and net result as of 31 March 2020.

8 Equity and net result as of 27 September 2020 (period from 16 April 2020 until 27 September 2020).

9 Equity and net result as of 30 September 2020.

10 Equity and net result as of 30 September 2020 (period from 1 January 2020 until 30 September 2020).

11 Equity and net result as of 30 September 2020 (period from 16 April 2020 until 30 September 2020).

12 Equity and net result as of 30 September 2020 (period from 28 April 2020 until 30 September 2020).

13 Equity and net result as of 30 September 2020 (period from 29 May 2020 until 30 September 2020).

14 Equity and net result as of 30 September 2020 (period from 26 June 2020 until 30 September 2020).

15 Equity and net result as of 30 September 2020 (period from 8 July 2020 until 30 September 2020).

16 Equity and net result as of 30 September 2020 (period from 28 September 2020 until 30 September 2020).

17 Equity and net result as of 31 December 2020.

18 Equity and net result as of 31 December 2020 (period from 8 July 2020 until 31 December 2020).

19 The entity was founded in the 2021 fiscal year.

20 Control and profit transfer agreement.

21 Exemption pursuant to Section 264, paragraph 3, German Commercial Code from the obligations to disclose the annual financial statements pursuant to Section 325 German Commercial Code.

22 Exemption pursuant to Section 264, paragraph 3, German Commercial Code from the preparation of a management report pursuant to section 264 et seq. German Commercial Code and from the obligations to disclose the annual financial statements pursuant to Section 325 German Commercial Code.

23 Exemption pursuant to Section 264b German Commercial Code from the obligations to prepare a management report as well as notes and from the obligations to disclose the annual financial statements.

24 Exemption pursuant to Section 264b German Commercial Code from the obligations to prepare a management report and to disclose the annual financial statements.

25 Because criteria pursuant to Section 285, No. 11, German Commercial Code are not met, investments in the affiliate are not disclosed.

26 Non-stock entity. Disclosure of ownership in percent does not apply.

27 The entity owns land of which Infineon is the sole tenant.

28 Infineon accounts for its interest using the equity method because Infineon has significant influence due to the right to hold a supervisory board position in combination with comprehensive minority rights and certain contractual rights in the context of development cooperation.

29 Infineon accounts for its interest using the equity method as Infineon lacks controlling influence due to certain contractual participation rights of the co-shareholder.

30 IFRS figures.

Neubiberg, 25 November 2021

Infineon Technologies AG
Management Board

Dr. Reinhard Ploss

Dr. Sven Schneider

Dr. Helmut Gassel

Jochen Hanebeck

Constanze Hufenbecher

Further information

Responsibility Statement by the Management Board

To the best of our knowledge, and in accordance with the applicable reporting principles, the Consolidated Financial Statements give a true and fair view of the assets, liabilities, financial position and profit or loss of the Group, and the Combined Management Report, which is combined with the Management Report of Infineon Technologies AG, includes a fair review of the development and performance of the business and the position of the Group, together with a description of the principal opportunities and risks associated with the expected development of the Group.

Neubiberg, 25 November 2021

Infineon Technologies AG
Management Board

Dr. Reinhard Ploss

Dr. Sven Schneider

Dr. Helmut Gassel

Jochen Hanebeck

Constanze Hufenbecher

For the Consolidated Financial Statements and Group Management Report we have issued an unqualified auditor's report. The English language text below is a translation of the auditor's report. The original German text shall prevail in the event of any discrepancies between the English translation and the German original. We do not accept any liability for the use of, or reliance on, the English translation or for any errors or misunderstandings that may derive from the translation.

Independent Auditor's Report

To Infineon Technologies AG, Neubiberg

Report on the Audit of the Consolidated Financial Statements and of the Group Management Report

Opinions

We have audited the consolidated financial statements of Infineon Technologies AG, Neubiberg, and its subsidiaries (the Group), which comprise the consolidated statement of financial position as at 30 September 2021, and the consolidated statement of profit or loss, consolidated statement of comprehensive income, consolidated statement of changes in equity and consolidated statement of cash flows for the financial year from 1 October 2020 to 30 September 2021, and notes to the consolidated financial statements, including a summary of significant accounting policies. In addition, we have audited the combined management report of Infineon Technologies AG and of the Group (hereinafter: the "group management report") for the financial year from 1 October 2020 to 30 September 2021.

In accordance with German legal requirements, we have not audited the content of those components of the group management report specified in the "Other Information" section of our auditor's report.

The group management report contains cross-references that are not required by law and which are marked as unaudited. In accordance with German legal requirements, we have not audited the cross-references and the information to which the cross-references refer.

In our opinion, on the basis of the knowledge obtained in the audit,

- › the accompanying consolidated financial statements comply, in all material respects, with the IFRSs as adopted by the EU, and the additional requirements of German commercial law pursuant to Section 315e (1) HGB [Handelsgesetzbuch: German Commercial Code] and, in compliance with these requirements, give a true and fair view of the assets, liabilities, and financial position of the Group as at 30 September 2021, and of its financial performance for the financial year from 1 October 2020 to 30 September 2021, and
- › the accompanying group management report as a whole provides an appropriate view of the Group's position. In all material respects, this group management report is consistent with the consolidated financial statements, complies with German legal requirements and appropriately presents the opportunities and risks of future development. Our opinion on the group management report does not cover the content of those components of the group management report specified in the "Other Information" section of the auditor's report. The group management report contains cross-references that are not required by law and which are marked as unaudited. Our audit opinion does not extend to the cross-references and the information to which the cross-references refer.

Pursuant to Section 322 (3) sentence 1 HGB, we declare that our audit has not led to any reservations relating to the legal compliance of the consolidated financial statements and of the group management report.

Basis for the Opinions

We conducted our audit of the consolidated financial statements and of the group management report in accordance with Section 317 HGB and the EU Audit Regulation No 537/2014 (referred to subsequently as “EU Audit Regulation”) and in compliance with German Generally Accepted Standards for Financial Statement Audits promulgated by the Institut der Wirtschaftsprüfer (IDW) [Institute of Public Auditors in Germany]. Our responsibilities under those requirements and principles are further described in the “Auditor’s Responsibilities for the Audit of the Consolidated Financial Statements and of the Group Management Report” section of our auditor’s report. We are independent of the group entities in accordance with the requirements of European law and German commercial and professional law, and we have fulfilled our other German professional responsibilities in accordance with these requirements. In addition, in accordance with Article 10 (2)(f) of the EU Audit Regulation, we declare that we have not provided non-audit services prohibited under Article 5 (1) of the EU Audit Regulation. We believe that the evidence we have obtained is sufficient and appropriate to provide a basis for our opinions on the consolidated financial statements and on the group management report.

Key Audit Matters in the Audit of the Consolidated Financial Statements

Key audit matters are those matters that, in our professional judgement, were of most significance in our audit of the consolidated financial statements for the financial year from 1 October 2020 to 30 September 2021. These matters were addressed in the context of our audit of the consolidated financial statements as a whole, and in forming our opinion thereon, we do not provide a separate opinion on these matters.

Impairment testing of goodwill

Please refer to note 2 in the notes to the consolidated financial statements for information on the accounting policies applied and the assumptions used. Information on the value of goodwill can be found under note 13.

The financial statement risk

The consolidated financial statements of Infineon Technologies AG reported goodwill in the amount of EUR 5,962 million as at 30 September 2021. At 26% of the balance sheet total, goodwill accounts for a considerable share of total assets.

Infineon tests goodwill for impairment in accordance with IAS 36 at the operating segment level annually as at 30 June, as well as in cases where events or changes to the prevailing conditions provide indications that the recoverable amount may have fallen below the carrying amount. The recoverable amount is the higher of fair value less costs of disposal and value in use. Goodwill is impaired if the carrying amount of the operating segment to which the goodwill is allocated exceeds the recoverable amount of this unit. Infineon determines the recoverable amount of the respective cash generating unit to which goodwill was allocated according to value in use.

Impairment testing of goodwill is complex and based on a range of assumptions that require judgement. Such judgement includes, among other elements, the assumptions found in the adopted corporate planning for a period of five years, such as revenue growth and margins, assumed long-term growth rates in perpetuity, which consider a steady state including the synergy effects of the prior-year acquisition of Cypress Semiconductor Corporation, and the underlying discount rates.

As a result of the impairment test performed, the Company did not identify any impairment. In light of the discretionary judgement of the assumptions underlying the impairment testing, there is the risk for the consolidated financial statements that a required impairment was not recognised. There is also the risk that the related disclosures in the notes are not appropriate.

Our audit approach

When assessing the impairment test, we also assessed the appropriateness of key assumptions. We assessed the Company’s calculation method and selected assumptions in terms of their appropriateness with the help of our valuation specialists. For this purpose, we checked that corporate planning was updated for the next five years and adopted by the Management Board. Using elements selected on the basis of risk, we had the staff responsible for preparing corporate planning explain to us in particular revenue and margin performance, as well as the long-term growth rates assumed in perpetuity, which consider a steady state including the synergy effects of the prior-year acquisition of Cypress Semiconductor Corporation. In this context, revenue performance in particular was critically reviewed and assessed based on publicly available market estimates and information to determine whether the revenue performance

used for measurement is within a reasonable range. We also confirmed the accuracy of the Company's previous forecasts by comparing the budgets of previous financial years with actual results and by analysing deviations.

We checked how the discount rates used were derived and their amounts. For this purpose, we compared the assumptions and data underlying the discount rates, in particular the risk-free rate, the market risk premium and the beta factor with our own assumptions and publicly available data.

To ensure the computational accuracy of the valuation method used, we verified the Company's calculations on the basis of selected risk-based elements.

In order to take account of the existing forecast uncertainty and the earlier cut-off date selected for impairment testing, the Company examined the effects of possible changes in the discount rates, revenue and margin performance and the long-term growth rate in perpetuity on the value in use by calculating alternative scenarios and comparing these with its own reported figures (sensitivity analysis). We have assessed this analysis. In order to take into account the earlier cut-off date for impairment testing, we also assessed the impact of events until 30 September 2021 on impairment testing.

Finally, we assessed whether the disclosures in the notes regarding impairment testing of goodwill are appropriate.

Our observations

The calculation method used for impairment testing of goodwill is appropriate and in line with the accounting policies to be applied.

The Company's assumptions used for measurement are appropriate.

The related disclosures in the notes are appropriate.

Other information

The Management Board and the Supervisory Board, respectively, are responsible for the other information. The other information comprises the following components of the group management report, whose content was not audited:

- › the separate combined non-financial report of the Company and Group, which is referred to in the group management report,
- › the combined corporate governance statement for the Company and the Group referred to in the group management report, and
- › information extraneous to management reports and marked as unaudited.

The other information also includes the remaining parts of the annual report. The other information does not include the consolidated financial statements, the group management report information audited for content and our auditor's report thereon.

Our opinions on the consolidated financial statements and on the group management report do not cover the other information, and consequently we do not express an opinion or any other form of assurance conclusion thereon.

In connection with our audit, our responsibility is to read the other information and, in so doing, to consider whether the other information

- › is materially inconsistent with the consolidated financial statements, with the group management report information audited for content or our knowledge obtained in the audit, or
- › otherwise appears to be materially misstated.

If, based on the work we have performed, we conclude that there is a material misstatement of this other information, we are required to report that fact. We have nothing to report in this regard.

Responsibilities of the Management Board and the Supervisory Board for the Consolidated Financial Statements and the Group Management Report

The Management Board is responsible for the preparation of consolidated financial statements that comply, in all material respects, with IFRSs as adopted by the EU, and the additional requirements of German commercial law pursuant to Section 315e (1) HGB and that the consolidated financial statements, in compliance with these requirements, give a true and fair view of the assets, liabilities, financial position, and financial performance of the Group. In addition, the Management Board is responsible for such internal control as they have determined necessary to enable the preparation of consolidated financial statements that are free from material misstatement, whether due to fraud or error.

In preparing the consolidated financial statements, the Management Board is responsible for assessing the Group's ability to continue as a going concern. It also has the responsibility for disclosing, as applicable, matters related to going concern. In addition, it is responsible for financial reporting based on the going concern basis of accounting unless there is an intention to liquidate the Group or to cease operations, or there is no realistic alternative but to do so.

Furthermore, the Management Board is responsible for the preparation of the group management report that, as a whole, provides an appropriate view of the Group's position and is, in all material respects, consistent with the consolidated financial statements, complies with German legal requirements, and appropriately presents the opportunities and risks of future development. In addition, the Management Board is responsible for such arrangements and measures (systems) as it has considered necessary to enable the preparation of the group management report that is in accordance with the applicable German legal requirements, and to be able to provide sufficient appropriate evidence for the assertions in the group management report.

The Supervisory Board is responsible for overseeing the Group's financial reporting process for the preparation of the consolidated financial statements and of the group management report.

Auditor's Responsibilities for the Audit of the Consolidated Financial Statements and of the Group Management Report

Our objectives are to obtain reasonable assurance about whether the consolidated financial statements as a whole are free from material misstatement, whether due to fraud or error, and whether the group management report as a whole provides an appropriate view of the Group's position and, in all material respects, is consistent with the consolidated financial statements and the knowledge obtained in the audit, complies with the German legal requirements and appropriately presents the opportunities and risks of future development, as well as to issue an auditor's report that includes our opinions on the consolidated financial statements and on the group management report.

Reasonable assurance is a high level of assurance, but is not a guarantee that an audit conducted in accordance with Section 317 HGB and the EU Audit Regulation and in compliance with German Generally Accepted Standards for Financial Statement Audits promulgated by the Institut der Wirtschaftsprüfer (IDW) will always detect a material misstatement. Misstatements can arise from fraud or error and are considered material if, individually or in the aggregate, they could reasonably be expected to influence the economic decisions of users taken on the basis of these consolidated financial statements and this group management report.

We exercise professional judgement and maintain professional scepticism throughout the audit. We also:

- › Identify and assess the risks of material misstatement of the consolidated financial statements and of the group management report, whether due to fraud or error, design and perform audit procedures responsive to those risks, and obtain audit evidence that is sufficient and appropriate to provide a basis for our opinions. The risk of not detecting a material misstatement resulting from fraud is higher than for one resulting from error, as fraud may involve collusion, forgery, intentional omissions, misrepresentations, or the override of internal controls.

- › Obtain an understanding of internal control relevant to the audit of the consolidated financial statements and of arrangements and measures (systems) relevant to the audit of the group management report in order to design audit procedures that are appropriate in the circumstances, but not for the purpose of expressing an opinion on the effectiveness of these systems.
 - › Evaluate the appropriateness of accounting policies used by the Management Board and the reasonableness of estimates made by the Management Board and related disclosures.
 - › Conclude on the appropriateness of the Management Board's use of the going concern basis of accounting and, based on the audit evidence obtained, whether a material uncertainty exists related to events or conditions that may cast significant doubt on the Group's ability to continue as a going concern. If we conclude that a material uncertainty exists, we are required to draw attention in the auditor's report to the related disclosures in the consolidated financial statements and in the group management report or, if such disclosures are inadequate, to modify our respective opinions. Our conclusions are based on the audit evidence obtained up to the date of our auditor's report. However, future events or conditions may cause the Group to cease to be able to continue as a going concern.
 - › Evaluate the overall presentation, structure and content of the consolidated financial statements, including the disclosures, and whether the consolidated financial statements present the underlying transactions and events in a manner that the consolidated financial statements give a true and fair view of the assets, liabilities, financial position and financial performance of the Group in compliance with IFRSs as adopted by the EU and the additional requirements of German commercial law pursuant to Section 315e (1) HGB.
 - › Obtain sufficient appropriate audit evidence regarding the financial information of the entities or business activities within the Group to express opinions on the consolidated financial statements and on the group management report. We are responsible for the direction, supervision and performance of the group audit. We remain solely responsible for our opinions.
 - › Evaluate the consistency of the group management report with the consolidated financial statements, its conformity with [German] law, and the view of the Group's position it provides.
 - › Perform audit procedures on the prospective information presented by the Management Board in the group management report. On the basis of sufficient appropriate audit evidence we evaluate, in particular, the significant assumptions used by the Management Board as a basis for the prospective information, and evaluate the proper derivation of the prospective information from these assumptions. We do not express a separate opinion on the prospective information and on the assumptions used as a basis. There is a substantial unavoidable risk that future events will differ materially from the prospective information.
- We communicate with those charged with governance regarding, among other matters, the planned scope and timing of the audit and significant audit findings, including any significant deficiencies in internal control that we identify during our audit.
- We also provide those charged with governance with a statement that we have complied with the relevant independence requirements, and communicate with them all relationships and other matters that may reasonably be thought to bear on our independence, and where applicable, the related safeguards.

From the matters communicated with those charged with governance, we determine those matters that were of most significance in the audit of the consolidated financial statements of the current period and are therefore the key audit matters. We describe these matters in our auditor's report unless law or regulation precludes public disclosure about the matter.

Other Legal and Regulatory Requirements

Report on Assurance in accordance with Section 317 (3a) HGB on the Electronic Reproduction of the Consolidated Financial Statements and the Group Management Report Prepared for Publication Purposes

We have performed assurance work in accordance with Section 317 (3a) HGB to obtain reasonable assurance about whether the reproduction of the consolidated financial statements and the group management report (hereinafter the "ESEF documents") contained in the electronic file "Infineon_Technologies_AG_KA+KLB_ESEF_2021-09-30.zip" (SHA256-Hashwert: f59eead9aa516c1fa1afefc8ed72d415a230c3f95c3892cd-38cc5aaa3514e019) provided and prepared for publication purposes complies in all material respects with the requirements of Section 328 (1) HGB for the electronic reporting format ("ESEF format"). In accordance with German legal requirements, this assurance only extends to the conversion of the information contained in the consolidated financial statements and the group management report into the ESEF format and therefore relates neither to the information contained in this reproduction nor any other information contained in the above-mentioned electronic file.

In our opinion, the reproduction of the consolidated financial statements and the group management report contained in the above-mentioned electronic file provided and prepared for publication purposes complies in all material respects with the requirements of Section 328 (1) HGB for the electronic reporting format. We do not express any opinion on the information contained in this reproduction nor on any other information contained in the above-mentioned file beyond this reasonable assurance conclusion and our audit opinion on the accompanying consolidated financial statements and the accompanying group management report for the financial year from 1 October 2020 to 30 September 2021 contained in the "Report on the Audit of the Consolidated Financial Statements and of the Group Management Report" above.

We conducted our assurance work of the reproduction of the consolidated financial statements and the group management report contained in the above-mentioned electronic file provided in accordance with Section 317 (3a) HGB and the IDW Assurance Standard: Assurance in accordance with Section 317 (3a) HGB on the Electronic Reproduction of Financial Statements and Management Reports Prepared for Publication Purposes (IDW AsS 410 10.2021). Accordingly, our responsibilities are further described below. Our audit firm has applied the IDW Standard on Quality Management 1: Requirements for Quality Management in Audit Firms (IDW QS 1).

The Company's Management Board is responsible for the preparation of the ESEF documents including the electronic reproduction of the consolidated financial statements and the group management report in accordance with Section 328 (1) sentence 4 item 1 HGB and for the tagging of the consolidated financial statements in accordance with Section 328 (1) sentence 4 item 2 HGB.

In addition, the Company's Management Board is responsible for the internal controls it considers necessary to enable the preparation of ESEF documents that are free from material non-compliance, whether due to fraud or error, with the requirements of Section 328 (1) HGB for the electronic reporting format.

The Supervisory Board is responsible for overseeing the process of preparing the ESEF documents as part of the financial reporting process.

Our objective is to obtain reasonable assurance about whether the ESEF documents are free from material intentional or unintentional non-compliance with the requirements of Section 328 (1) HGB. We exercise professional judgement and maintain professional scepticism throughout the audit. We also:

- › Identify and assess the risks of material intentional or unintentional non-compliance with the requirements of Section 328 (1) HGB, design and perform assurance procedures responsive to those risks, and obtain assurance evidence that is sufficient and appropriate to provide a basis for our assurance opinion.

- › Obtain an understanding of internal control relevant to the assessment of the ESEF documents in order to design assurance procedures that are appropriate in the circumstances, but not for the purpose of expressing an assurance opinion on the effectiveness of these controls.
- › Evaluate the technical validity of the ESEF documents, i.e., whether the electronic file provided containing the ESEF documents meets the requirements of Commission Delegated Regulation (EU) 2019/815 on the technical specification for this electronic file.
- › Evaluate whether the ESEF documents enable an XHTML reproduction with content equivalent to the audited consolidated financial statements and the audited group management report.
- › Evaluate whether the tagging of the ESEF documents with Inline XBRL technology (iXBRL), in accordance with Articles 4 and 6 of Commission Delegated Regulation (EU) 2019/815 in the version valid on the reporting date, enables an appropriate and complete machine-readable XBRL copy of the XHTML reproduction.

Further information pursuant to Article 10 of the EU Audit Regulation

We were elected as group auditor at the annual general meeting on 25 February 2021. We were engaged by the Supervisory Board on 3 May 2021. We have been the group auditor of Infineon Technologies AG without interruption since financial year 2000.

We declare that the opinions expressed in this auditor's report are consistent with the additional report to the Audit Committee pursuant to Article 11 of the EU Audit Regulation (long-form audit report).

Other matter – Use of the Auditor's Report

Our auditor's report should always be read in conjunction with the audited consolidated financial statements and the audited group management report as well as the audited ESEF documents. The consolidated financial statements and the group management report converted into ESEF format – including the versions to be published in the German Federal Gazette [Bundesanzeiger] – are merely electronic reproductions of the audited consolidated financial statements and the group audited management report and do not replace these. In particular, the ESEF assurance report and our assurance conclusion contained therein can only be used in conjunction with the audited ESEF documents provided in electronic form.

German Public Auditor Responsible for the Engagement

The German Public Auditor responsible for the engagement is Michael Pritzer.

Munich, 25 November 2021

KPMG AG
Wirtschaftsprüfungsgesellschaft

Pritzer
Wirtschaftsprüfer
[German Public Auditor]

Schmitt
Wirtschaftsprüfer
[German Public Auditor]

Applications and product range

Automotive

Applications

Assistance systems and safety systems

- › ABS (Anti-blocking system)
- › Airbag
- › Automatic parking
- › Blind spot detection
- › Cruise control
- › Distance control
- › Electronic chassis control
- › Electronic power steering
- › Emergency braking assistant
- › ESP (Electronic Stability Program)
- › Lane departure warning system
- › Tire pressure monitoring system

Comfort electronics

- › Air conditioning
- › Body control units
- › Door electronics
- › Electronic seat adjustment
- › Hatch door
- › Lighting
- › Power window
- › Steering
- › Sunroof
- › Suspension
- › Windshield wipers

Infotainment

- › Connectivity for in-cabin infotainment
- › Digital instrument cluster

Powertrain

- › Battery charging control
- › Battery management
- › Combustion engine control
- › Electric motor control
- › Generator control
- › Start-stop system
- › Transmission control

Security

- › Communication
 - Car-to-car
 - Car-to-infrastructure
- › Original spare parts authentication
- › Protection against manipulation (e.g., odometer)
- › Protection against software manipulation
- › Tachograph

Product range

- › 32-bit automotive microcontrollers for powertrain, safety, driver assistance systems, infotainment and digital display systems
- › 3D ToF sensors
- › Discrete power semiconductors
- › IGBT modules
- › Industrial microcontrollers
- › Magnetic and pressure sensors
- › Memory ICs (NOR flash, SRAM, nvSRAM, F-RAM)
- › Power ICs
- › Radar sensor ICs (77 GHz)
- › SiC diodes, SiC MOSFETs and SiC modules
- › Transceivers (CAN, CAN FD, LIN, Ethernet, FlexRay™)
- › Voltage regulators

Industrial Power Control

Applications

Energy generation

- › Photovoltaic systems
- › Wind power turbines

Energy storage

- › Grid stability
- › Home usage
- › Urban district
- › Wall box

Energy transmission

- › FACTS (Flexible AC Transmission Systems)
- › Offshore wind farm HVDC transmission lines
- › Overland HVDC transmission lines

Home appliances

- › Air conditioners
- › Dishwashers
- › Induction cooktops
- › Microwave ovens
- › Refrigerators
- › Vacuum cleaners
- › Washing machines

Industrial drives¹

- › Air conditioning technology
- › Automation technology
- › Drives technologies
- › Elevator systems
- › Escalators

- › Materials handling
- › Oil derricks
- › Pipelines
- › Rolling mills

Industrial power supplies

- › Auxiliary power supplies
- › Battery chargers
- › Charging stations for electric vehicles
- › Home energy storage
- › Uninterruptable power supplies

Industrial robotics

Industrial vehicles

- › Agricultural vehicles
- › Construction vehicles
- › Electric delivery vehicles
- › Forklifts
- › Hybrid buses

Traction

- › High-speed trains
- › Locomotives
- › Metro trains
- › Trams

¹ Including motors, compressors, pumps and fans.

Product range

- › Bare die business
- › Discrete IGBTs
- › Driver ICs
- › IGBT modules (low-power, medium-power, high-power)
- › IGBT module solutions including IGBT stacks
- › Intelligent IGBT modules with integrated control unit, driver and switch
- › SiC diodes, SiC MOSFETs, SiC modules

Power & Sensor Systems

Applications

Audio amplifiers

- › Battery-powered loudspeakers
- › Smart speakers

Automotive electronics

- › Blind spot detection
- › In-cabin USB PD charging
- › Onboard charger
- › Power train for low-speed electric vehicles

BLDC motor

- › Battery-powered gardening equipment, e.g.,
 - Hedge trimmers
 - Lawn mowers
- › Battery-powered home appliances, e.g.,
 - Vacuum cleaners
- › Battery-powered power tools, e.g.,
 - Cordless screwdrivers
 - Drills
 - Power saws
- › eBikes
- › eScooters
- › Multi-copters

Cellular communications infrastructure

- › Base stations

Charging stations for electric vehicles

Special applications in harsh environments

- › Aerospace systems
- › Aviation technologies
- › Defense technologies
- › Oil and gas exploration
- › Submarine telecommunications

Human-machine interaction

IoT

- › Communications
- › Sensors
- › Smart speakers
- › Voice control

LED and conventional lighting systems

Microinverter for roof-top systems

Mobile devices

- › Activity trackers
- › Health care trackers
- › Navigation devices
- › Smartphones
- › Tablets

Power management

- › Consumer electronics
- › Data centers
- › Home appliances
- › Mobile devices
- › PCs and notebooks
- › Servers
- › Telecommunication technology

Product range

- › 3D ToF sensors
- › Chips for gas sensors
- › Chips for MEMS microphones
- › Chips for pressure sensors
- › Control ICs for power switches
- › Customized chips (ASICs)
- › Discrete low-voltage, mid-voltage and high-voltage power MOSFETs (Si-based)
- › GaN power switches
- › GPS low-noise amplifier
- › Low-voltage and high-voltage driver ICs
- › Radar sensor ICs (24 GHz, 60 GHz)
- › RF antenna switches
- › RF power transistors
- › SiC diodes, SiC MOSFETs
- › TVS (transient voltage suppressor) diode
- › USB controller

Connected Secure Systems

Applications

Authentication

- › Accessories
- › Brand protection
- › Game consoles
- › Industrial control systems
- › Printer cartridges

Automotive

- › Connected vehicles
 - eCall
 - Car-to-car communications
 - Car-to-infrastructure communications
- › Electronic toll collection (Toll Collect)
- › In-cabin infotainment
- › Protection against manipulation (e.g., tachographs)

Consumer electronics

- › Game consoles
- › Remote control
- › Smart watches and activity trackers

Government identification documents

- › Driver's licenses
- › Healthcare cards
- › National identity cards
- › Passports
- › Social insurance cards

IoT

- › Industry 4.0
- › IT equipment
- › Smart city
- › Smart home

Mobile communications

- › Embedded SIM
(machine-to-machine communication)
 - Consumer applications
 - IoT applications
- › SIM cards

Payment systems

- › Credit/debit cards
- › Mobile payment
- › NFC-based contactless payment

Ticketing, access control

Trusted Computing

Product range

- › Connectivity solutions (Wi-Fi, Bluetooth, BLE)
- › Embedded security controllers
- › Microcontroller for consumer electronics and industrial applications
- › Security controllers (contact-based, contactless, dual-interface)

Chart overview

	Page		Page
C01 Our growth areas and growth drivers are derived from megatrends in society	22	C22 Market share in IGBT modules in the 2020 calendar year	68
C02 Additional semiconductor demand per vehicle raised by electromobility	28	C23 Revenue and Segment Result of the Industrial Power Control segment	69
C03 We are linking the real and the digital world	32	C24 Market share for MOSFETs in the 2020 calendar year	73
C04 Strategic growth model	36	C25 Market share for power ICs in the 2020 calendar year	73
C05 Worldwide discrete power semiconductors and modules market share in the 2020 calendar year	36	C26 Market share of MEMS microphones die suppliers in the 2020 calendar year (by units)	73
C06 Siltectura's Cold Split technology allows splitting of SiC boules as well as SiC wafers with minimum loss of material	37	C27 Revenue and Segment Result of the Power & Sensor Systems segment	74
C07 Market share in the total semiconductor market in the 2020 calendar year	38	C28 Market share for security ICs (excl. NFC controller; excl. NFC embedded Secure Element) in the 2020 calendar year	78
C08 System knowhow and services are becoming more and more a differentiating factor	39	C29 Market share for security ICs (excl. NFC controller; excl. NFC embedded Secure Element) in the 2020 calendar year by application	78
C09 The main stages of the semiconductor value chain	51	C30 Market share for microcontrollers in the 2020 calendar year	78
C10 Top 20 semiconductor manufacturers in the 2020 calendar year	53	C31 Revenue and Segment Result of the Connected Secure Systems segment	79
C11 Global semiconductor sales in the 2020 calendar year by region (total market size US\$473 billion)	54	C32 R&D expenses	80
C12 Top 20 semiconductor consumer in the 2020 calendar year	54	C33 Infineon owns the key components for xEV charging stations	82
C13 Revenue by segment in the 2021 fiscal year	56	C34 Investments	88
C14 Dividend per share for the 2010 to 2021 fiscal years	57	C35 Development of the Infineon Technologies AG share compared to Germany's DAX Index, the Philadelphia Semiconductor Index (SOX) and the Dow Jones US Semiconductor Index for the 2021 fiscal year (daily closing prices)	97
C15 Core competencies in the segments	59	C36 Shareholder structure as of the end of the 2021 fiscal year	98
C16 World market for automotive semiconductors in the 2020 calendar year	63	G37 Revenue by segment	100
C17 Market share for automotive semiconductors in the 2020 calendar year	63	G38 Revenue by segment in the 2021 fiscal year	100
C18 Market share of Infineon for automotive semiconductors by region in the 2020 calendar year	63	G39 Financial debt by currencies	104
C19 Revenue and Segment Result of the Automotive segment	64	G40 Risk assessment matrix	113
C20 Market share for discrete IGBTs in the 2020 calendar year	68	G41 Diversity target	139
C21 Market share for IPMs in the 2020 calendar year	68		

List of abbreviations

AC-DC	alternating current to direct current conversion	IIoT	Industrial Internet of Things
ADAS	advanced driver assistance system	IoT	Internet of Things
AI	artificial intelligence	IPM	intelligent power module
ASIC	application-specific integrated circuit	LED	light-emitting diode
ASIL	automotive safety integrity level	MEMS	micro-electromechanical system
BLDC	brushless direct current	ML	machine learning
BLE	Bluetooth Low Energy	MOSFET	metal-oxide-semiconductor field-effect transistor
BT	Bluetooth	NFC	near-field communication
CIoT	Consumer Internet of Things	PHEV	plug-in hybrid electric vehicles
CMOS	complementary metal-oxide-semiconductor	PSoC	programmable system-on-chip
CPU	central processing unit	RF	radio frequency
DC-DC	direct current to direct current conversion	Si	silicon
FHEV	full hybrid electric vehicles	SiC	silicon carbide
FPGA	field programmable gate array	ToF	time-of-flight
GaN	gallium nitride	TPM	trusted platform module
HMI	human-machine interaction	USB (USB PD)	universal serial bus (universal serial bus standard power delivery)
HVDC	high-voltage DC transmission	Wi-Fi	wireless fidelity
IC	integrated circuit		
IGBT	insulated gate bipolar transistor		

Financial calendar 2022

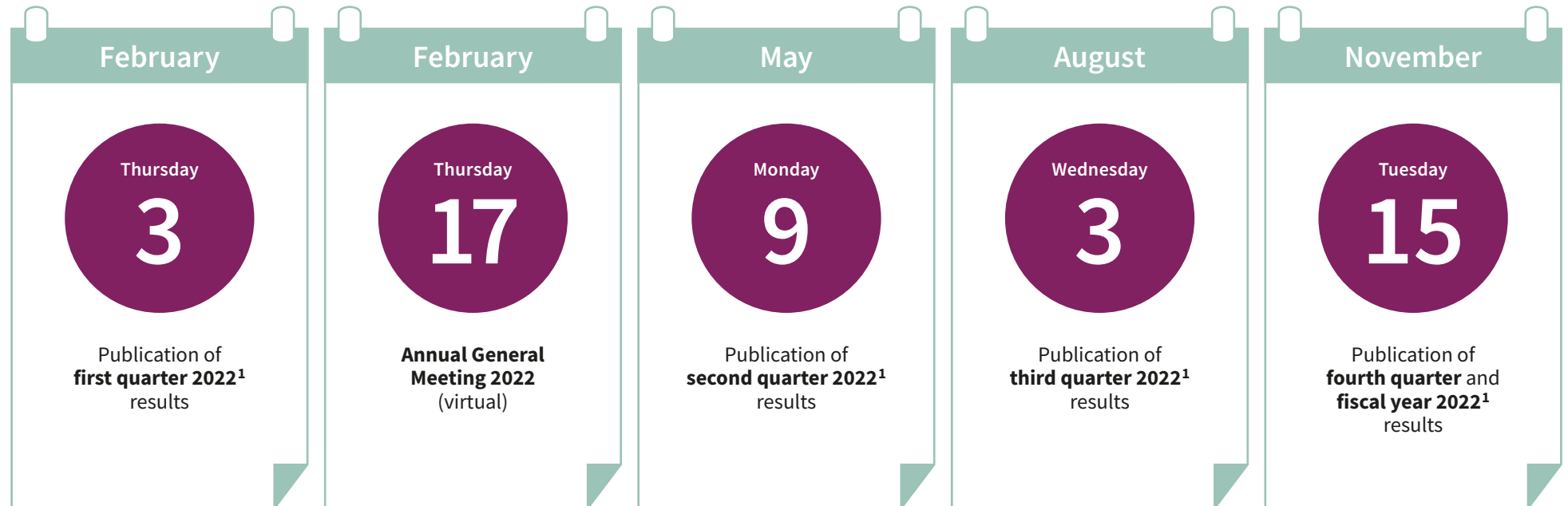

¹ Preliminary

Imprint

Published by:	Infineon Technologies AG, Neubiberg (Germany)
Editors:	Investor Relations, Accounting, Consolidation & Reporting
Copy deadline:	25 November 2021
Fiscal year:	1 October to 30 September
Independent auditors:	KPMG AG Wirtschaftsprüfungsgesellschaft, Munich (Germany)
Designed by:	HGB Hamburger Geschäftsberichte GmbH & Co. KG, Hamburg (Germany)
Photography:	Page 6, 10: Werner Bartsch, Hamburg (Germany)

Note

The following were brand names of Infineon Technologies AG in the 2021 fiscal year:

Infineon, the Infineon logo, AURIX™, CIPOS™, CoolGaN™, CoolMOS™, CoolSiC™, EiceDRIVER™, FlexRay™, HybridPACK™, iMOTION™, ModusToolbox™, OPTIGA™, PrimePACK™, PSoC™, SECORA™, TRAVEO™, XENSIV™, XMC™.

Visit us on the web: www.infineon.com



Forward-looking statements

This report contains forward-looking statements and/or assessments about the business, financial condition, performance and strategy of the Infineon Group. These statements and/or assessments are based on assumptions and management expectations resting upon currently available information and present estimates. They are subject to a multitude of uncertainties and risks, many of which are partially or entirely beyond Infineon's control. Infineon's actual business development, financial condition, performance and strategy may therefore differ materially from what is discussed in this report.

Specific disclaimer for Informa Tech – former IHS Markit Technology – reports, data and information referenced in this document:

The Informa Tech reports, data and information referenced herein (the “Informa Tech Materials – mostly former IHS Markit Technology Materials”) are the copyrighted property of Informa Tech Research Ltd. and its subsidiaries (“Informa Tech”) and represent data, research, opinions or viewpoints published by Informa Tech, and are not representations of fact. The Informa Tech Materials speak as of the original publication date thereof and not as of the date of this document. The information and opinions expressed in the Informa Tech Materials are subject to change without notice and neither Informa Tech nor, as a consequence, Infineon have any duty or responsibility to update the Informa Tech Materials or this publication as a result. Informa Tech Materials are delivered on an “as-is” and “as-available” basis. No representation or warranty, express or implied, is made as to the fairness, accuracy, completeness or correctness of the information, opinions and conclusions contained in the Informa Tech Materials. To the maximum extent permitted by law, Informa Tech and its affiliates, IHS Markit and its Affiliates and their respective, officers, directors, employees and agents, disclaim any liability (including, without limitation, any liability arising from fault or negligence) as to the accuracy or completeness or use of the Informa Tech Materials. Informa Tech and/or IHS Markit will not, under any circumstance whatsoever, be liable for any trading, investment, commercial or other decisions based on or made in reliance of the Informa Tech Materials. The “IHS Markit” brand and logo have been licensed for use by Informa Tech. The “IHS Markit” brand and logo and any third-party trademarks used in the IHS Markit Technology Materials are the sole property of IHS Markit Group or their respective third-party owners.

Specific disclaimer for IHS Markit – reports, data and information referenced in this document:

The IHS Markit reports, data and information referenced herein (the “IHS Markit Materials”) are the copyrighted property of IHS Markit Ltd. and its subsidiaries (“IHS Markit”) and represent data, research, opinions or viewpoints published by IHS Markit, and are not representations of fact. The IHS Markit Materials speak as of the original publication date thereof and not as of the date of this document. The information and opinions expressed in the IHS Markit Materials are subject to change without notice and neither IHS Markit nor, as a consequence, Infineon have any duty or responsibility to update the IHS Markit Materials or this publication. Moreover, while the IHS Markit Materials reproduced herein are from sources considered reliable, the accuracy and completeness thereof are not warranted, nor are the opinions and analyses which are based upon it. IHS Markit and the trademarks used in the Data, if any, are trademarks of IHS Markit. Other trademarks appearing in the IHS Markit Materials are the property of IHS Markit or their respective owners.

Infineon Technologies AG

Headquarters:

Contact for Investors and Analysts:

Media Contact:

Visit us on the web:

Am Campeon 1–15, D-85579 Neubiberg near Munich (Germany), Phone + 49 89 234-0

investor.relations@infineon.com, Phone + 49 89 234-26655, Fax + 49 89 234-955 2987

media.relations@infineon.com, Phone + 49 89 234-28480, Fax + 49 89 234-955 4521

www.infineon.com