

DEBUG

Debug Support

AURIX™ TC2xx Microcontroller Training
V1.0 2019-03



[Please read the Important Notice and Warnings at the end of this document](#)

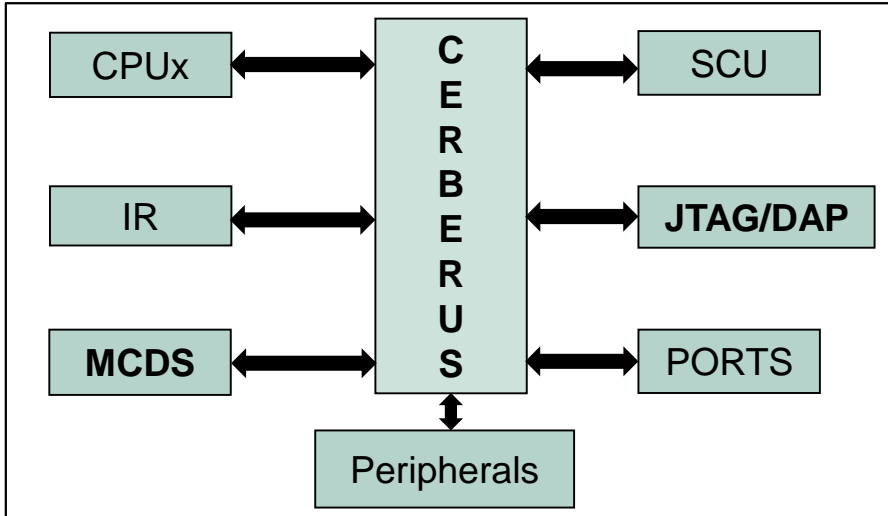

Highlights

Debug support is based on two components: OCDS (On-Chip Debug System) and MCDS (Multi Core Debug Solution), which offer debugging and performance optimization for the software and system hardware.

Eight hardware breakpoints for instruction and data address together with dedicated interrupt resources make the debug events easy to handle.

Key Features

Effective debug & trace solution

Non-intrusive debugging with trace

Low cost tool interface (DAP)

Customer Benefits

- › Fast bug fixing and performance analysis at very low costs
- › Debugging & tracing do not influence system's timing behavior
- › Debugging with the same tooling possible from the lab to the target system

Effective debug & trace solution

- › Debugging of specific features can be done via Trigger Lines that collect debug events from various sources (e.g. CPUs, interrupt requesters, peripherals, MCDS, input pins)
- › The Central Suspend Switch allows the user to configure which CPUs or peripherals to be halted as reaction to a debug event
- › Tracing enables the user to create a log of the program execution, which helps in finding the causes of system's misbehavior and analyzing of performance
- › For example, tracing the interrupt system offers valuable information about which interrupts are serviced by a particular CPU

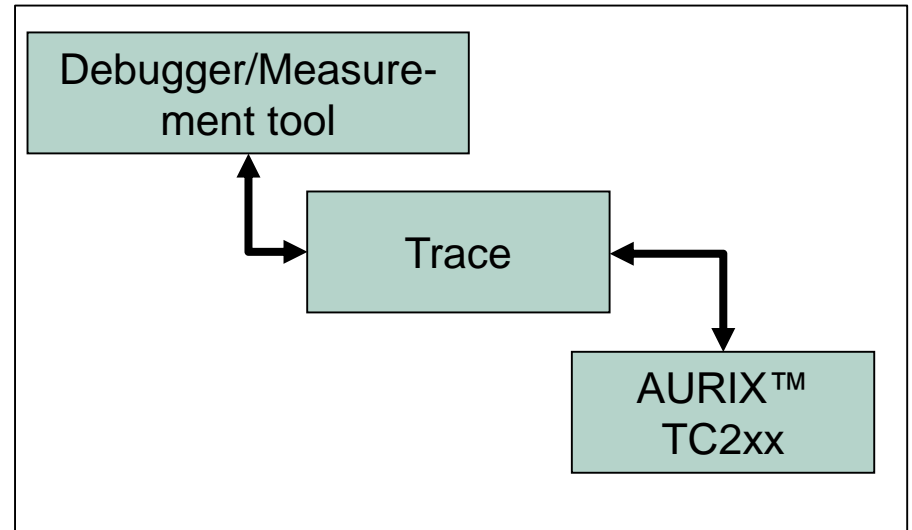
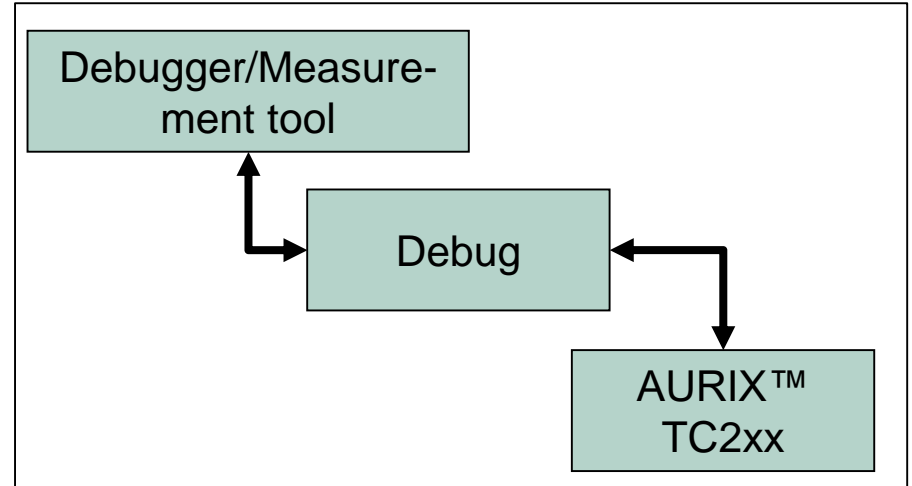

Non-intrusive debugging with trace

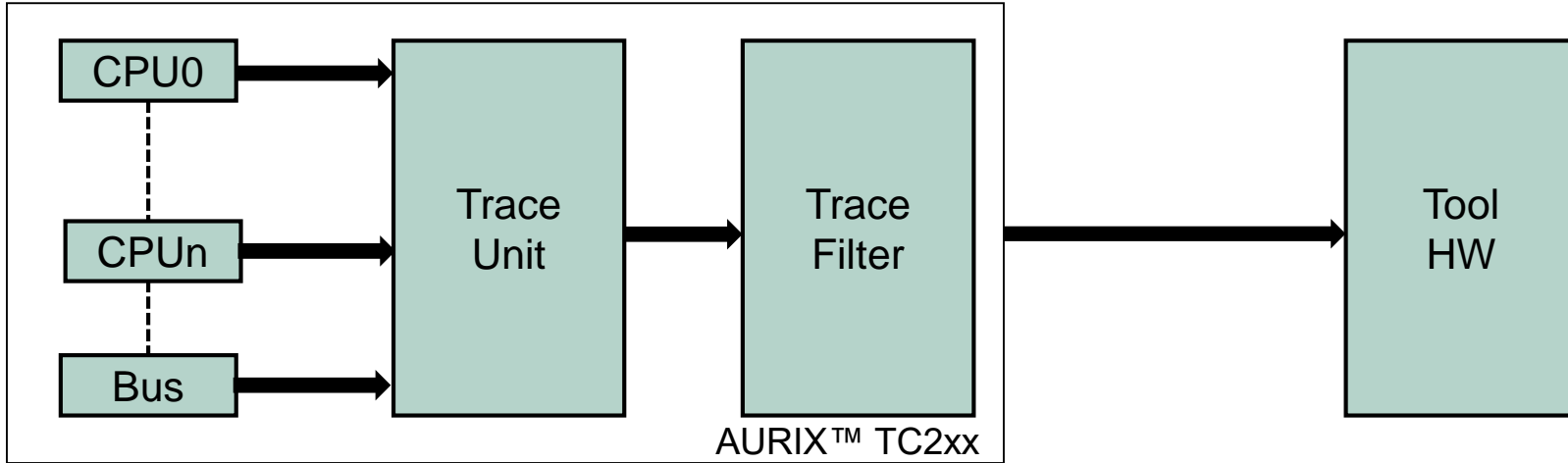

- › The debugging with trace enables the user to get a log of program execution with time information added. The main advantage of this type of debugging is that it does not impact the user's code execution and timing behavior
- › The full trace capabilities are available together with the MCDS module (on emulation devices), where two CPUs can be monitored in parallel together with the busses
- › Depending on the complexity of the trace, DAP (up to 15 MByte/s) or Aurora (2.5 Gbit/s) can be used as interfaces

Low cost tool interface (DAP)

- › The Device Access Port (DAP) is a convenient way to connect a debugger or a measurement system to AURIX™ TC2xx due to the small dimension and low pin-count (right figure)
- › The synchronous clocking ensure that DAP is a high-speed interface, enabling a block access up to 15 MByte/s for block read or write
- › The protocol is based on telegrams protected by 6-bit CRC (Cyclic Redundancy Code), which minimizes the overhead for the protocol

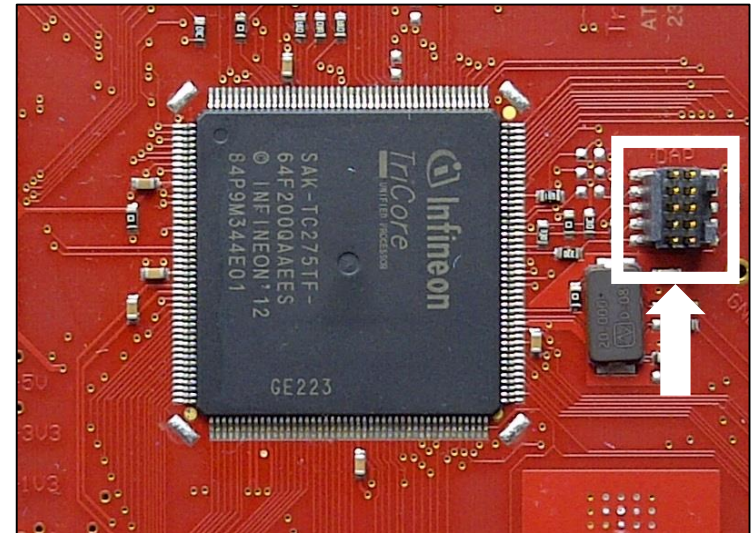
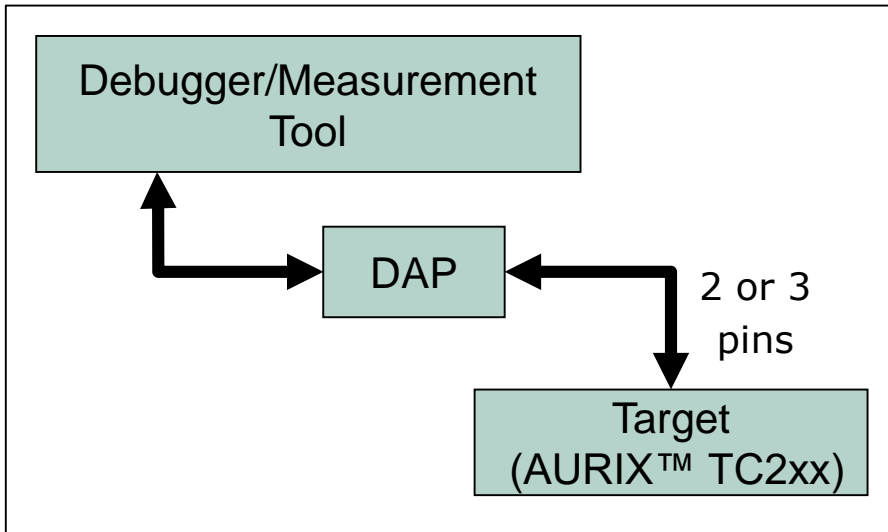

DEBUG

System Integration

- › OCDS infrastructure is a network of tightly coupled add-ons to other system components
- › This structure enables:
 - Peripheral triggering and tracing
 - Collect debug events from various sources like CPUs, interrupt requesters, bus controllers, peripherals, etc.
- › MCDS enables the user to trace up to two CPUs together with the busses

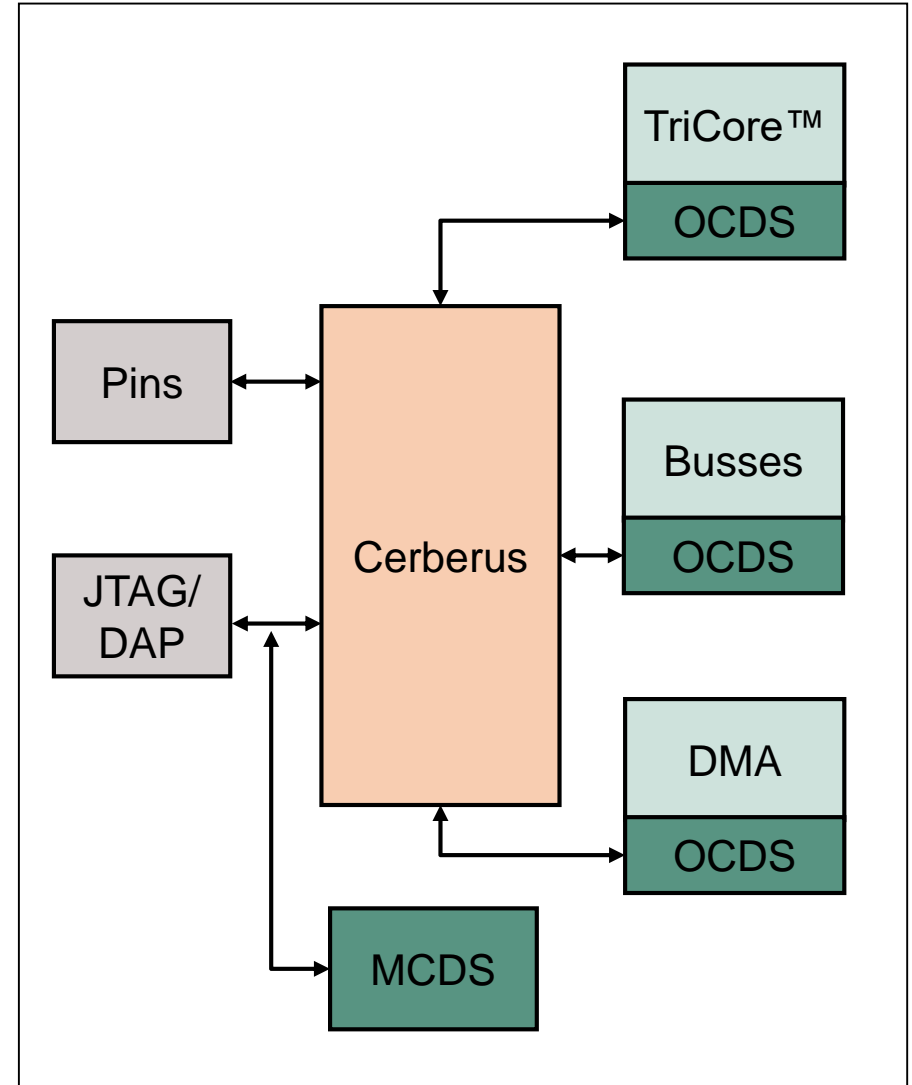

Application Example

Debugging an issue of the system

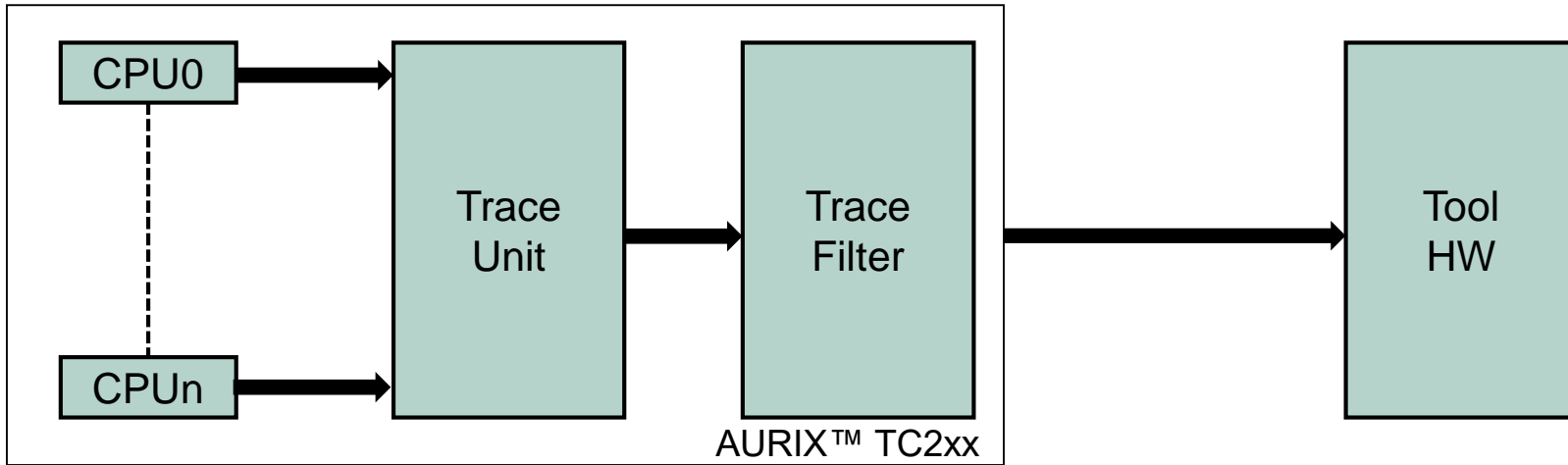

Overview

- › Description of issue: An unintended system behavior (e.g. random reset) is observed, the root cause is unknown
- › Procedure: Analyze the trace data taken around the point in time when the issue appears

Advantages

- › Non-intrusive method to find issues (no risk of errors due to changes in the code)
- › Trace data can contain both program and data information, therefore enabling the user to debug easily any possible mistake in the software

Trademarks

All referenced product or service names and trademarks are the property of their respective owners.

Edition 2019-03

Published by

**Infineon Technologies AG
81726 Munich, Germany**

**© 2019 Infineon Technologies AG.
All Rights Reserved.**

Do you have a question about this document?

Email: erratum@infineon.com

Document reference

AURIX_Training_1_Debug_Support

IMPORTANT NOTICE

The information given in this document shall in no event be regarded as a guarantee of conditions or characteristics (“Beschaffenheitsgarantie”).

With respect to any examples, hints or any typical values stated herein and/or any information regarding the application of the product, Infineon Technologies hereby disclaims any and all warranties and liabilities of any kind, including without limitation warranties of non-infringement of intellectual property rights of any third party.

In addition, any information given in this document is subject to customer’s compliance with its obligations stated in this document and any applicable legal requirements, norms and standards concerning customer’s products and any use of the product of Infineon Technologies in customer’s applications.

The data contained in this document is exclusively intended for technically trained staff. It is the responsibility of customer’s technical departments to evaluate the suitability of the product for the intended application and the completeness of the product information given in this document with respect to such application.

For further information on the product, technology, delivery terms and conditions and prices please contact your nearest Infineon Technologies office (www.infineon.com).

WARNINGS

Due to technical requirements products may contain dangerous substances. For information on the types in question please contact your nearest Infineon Technologies office.

Except as otherwise explicitly approved by Infineon Technologies in a written document signed by authorized representatives of Infineon Technologies, Infineon Technologies’ products may not be used in any applications where a failure of the product or any consequences of the use thereof can reasonably be expected to result in personal injury.